



DFROBOT
DRIVE THE FUTURE

BOSON

Science Design Kit

Tutorial



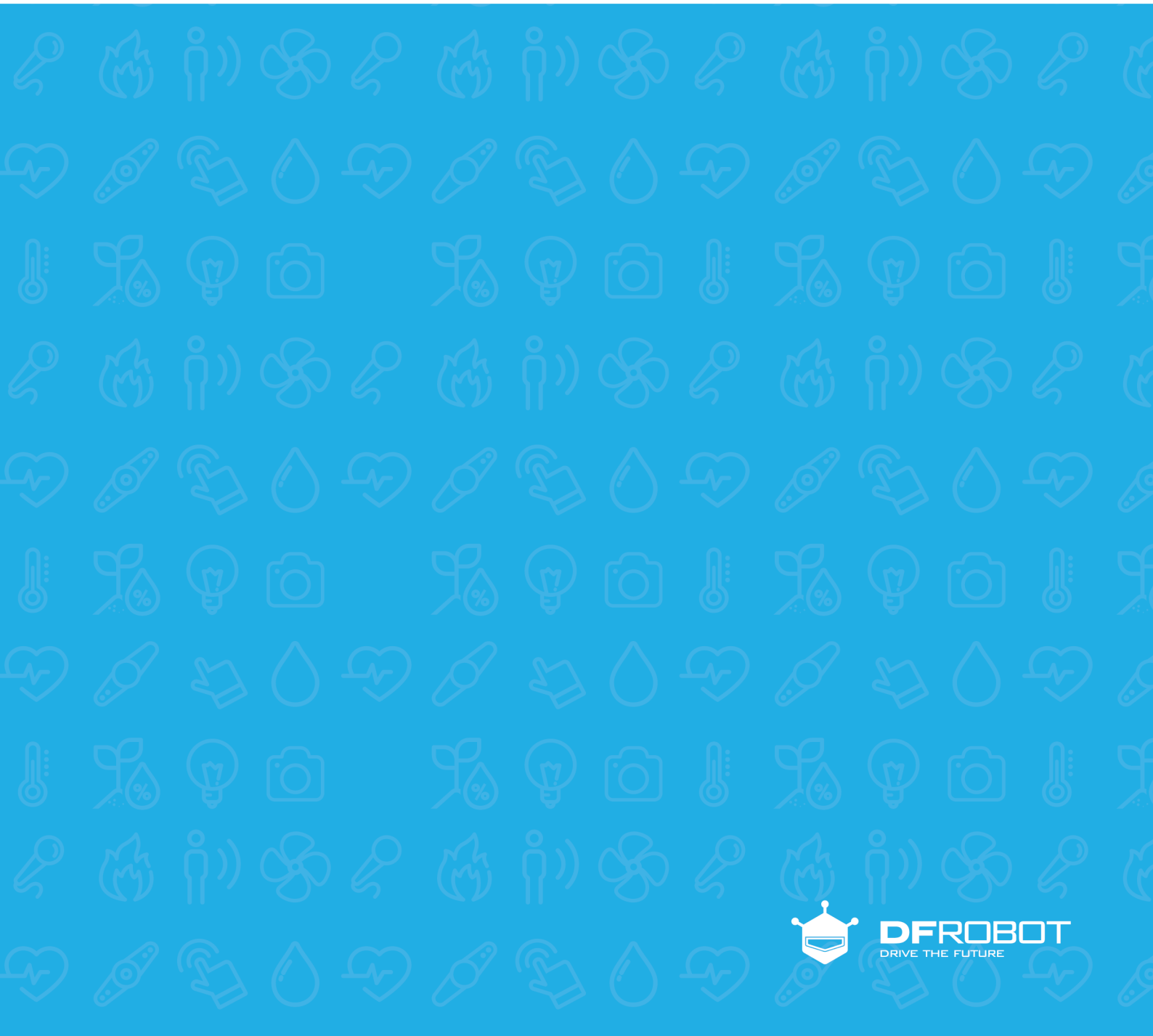

DFROBOT
DRIVE THE FUTURE

Contents

Lesson 1: Why Are Electrical Wires?

Lesson 2: Why Does the Moon Shine at Night?

Lesson 3: How to Make Your Living?

Lesson 4: Does the Car Sun Shield Really?

Lesson 5: Why Is It Summer After Spring ,not Winter?

Lesson 6: Why Do Very Few Plants Grow in Deserts?

Lesson 7: How Does the Water Cycle Work?

Lesson 8: Solar Oven

Lesson 9: Fridge Door-closing Reminder

Lesson 10: Automatic Plants Fill Light Introduction

Lesson 11: Automatic Watering

Lesson 12: Burglar Alarm

LESSON 1: Why Are Electrical Wires Covered in Plastic?

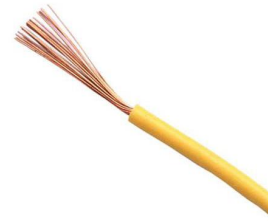

Introduction

Standards

NGSS

5-PS1-3 Matter and Its Interactions : Make observations and measurements to identify materials based on their properties.

Science - Grade 3-5



Overview

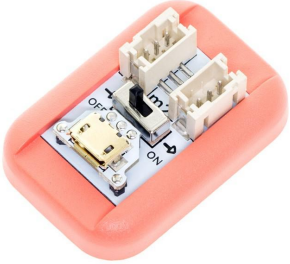

Observe a phenomenon in daily life, explore the question---"Why are electrical wire covered in plastic?" to lead out the concept of conductivity, and help students get to know conductor and insulator by experimenting so as to understand the principle of electrical wire and learn the electrical safety basics.

Materials

BOSON Module	Image	Function
--------------	-------	----------

<p>Battery Holder</p> <p>(3x AAA batteries installed)</p>		<p>4.5V Power Supply</p>
<p>MainBoard-11O (m2)</p>		<p>Supply power for other modules</p>
<p>Conductivity Switch (i12)</p>		<p>Use with alligator clips to detect the conductivity of objects</p>

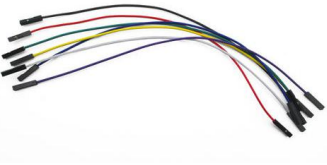
Display Module(o11)		Provide visual effect for users to check experiment results
BOSON cable *2		Use with 3Pin Foolproof connector to connect other modules

Additional Materials	Image	Function
Electric wires		Experimental Subjects
<u>Wire stripper</u>		Used to peel off the electrical wire. If you don' t have such a tool, find scissors or other suitable tools.

		Please be careful during the operation.
--	--	---

Engage

If we observe the electrical equipment in our home, we can find that the electrical wires for household appliances are all wrapped in plastic, but their power plugs are bare metal. Why is that? What is inside an electrical cord? Why does it have plastic coverings? Take a guess!



Explore

After making a supposition about an unknown question, we have to prove it by performing experiments.

This experiment consists of two parts: 1. Find the component of an electrical wire; 2. Explore the properties of all component parts and then explain why electrical wires are covered in plastic.

Part 1 What are the components of an electrical wire?

Preparation

To explore the composition of electrical wire, we have to prepare electrical cables, and wire stripper (or scissors).

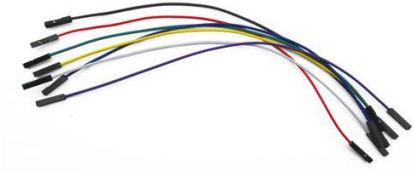
	
Wire Stripper	Electrical Wire (Dupont wires are used here)

Step

Cut the end of the Dupont wire and peel off its electric skin.

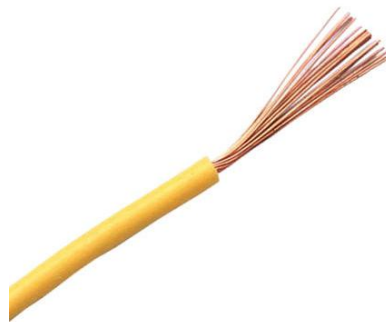

Conclusion

From the above, we can see that the electrical wire mainly has two parts: wire core, and plastic coverings.

Make a Conjecture

Take a guess, what are the functions of each part of the electrical wire?

Question 1: What is the function of the electrical wire core?	Supposition 1:
Question 2: What is the function of electrical wire plastic coverings?	Supposition 2:





Part 2 What is the function of electrical wire plastic coverings?

We know that an electrical cable is used to transfer power. But which part of the electrical wire does the work, wire core or plastic coverings? Can the human body transfer power too? Let's look for the answers one by one through experiments, and record the results in the form below.

Object	Can it transfer power?
Wire Core	
Plastic Coverings	
Human Body	

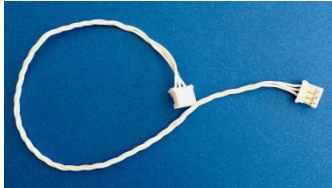

Preparation

Take out the following module blocks from BOSON Science Design Kit.

 <p>Display Module(o11)</p>	 <p>MainBoard-1IO (m2)</p>	 <p>Battery Holder (3x AAA batteries installed)</p>
 <p>Conductivity Switch (i12)</p>		 <p>BOSON cable *2</p>

Step

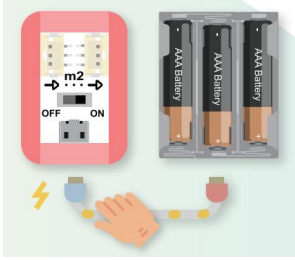
1. Build an experimental circuit to detect if the wire core, wire plastic coverings and human body can transfer power?

<p>1-1 Connect the Battery Holder and two Module Cables to the Main Board.</p>	  <p>The cable's pin header should be plugged in completely so that it is not easy to pull it out.</p>
--	---

1-2 Connect the Display Module to the output side of the Main Board with a Module Cable.

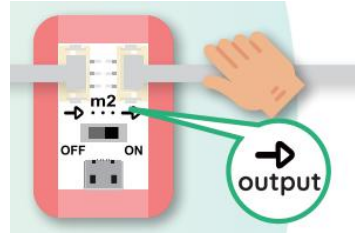

1-3 Clip two alligator clips onto the two sides of the conductivity switch respectively.



1-4 Connect the Conductivity Switch to the input side of the Main Board with a Module Cable.

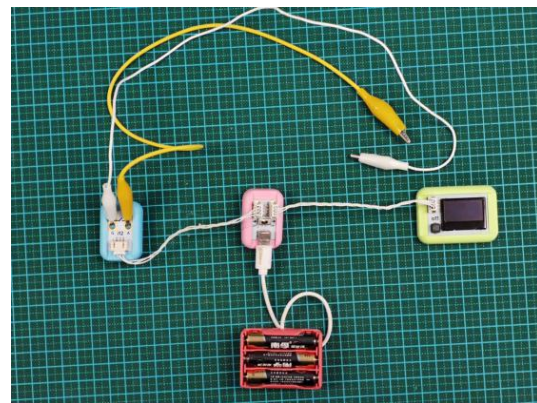

1-5 Switch the Main board "On"

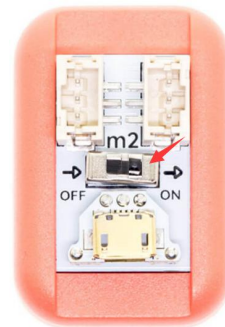

1-6 Press the black button on the module several times until the "i12 Conductivity" is displayed.



1-7 When the two alligator clips are connected, if the OLED module displays a lightning bolt symbol, the circuit is connected.



2. When the circuit building is finished, make the two alligator clips contact each other, then there is a lightning bolt symbol appearing on the screen, which indicates that the electrical power can be transferred; Separate the two alligator clips, the lightning bolt sign disappears, which means the power transmission fails. Therefore, we can clip the two alligator clips onto electrical wire core, plastic coverings, and human body to test whether they can transfer power.

2-1 Clip the two alligator clips onto the two ends of the electrical wire core, record the result in the form. (Lightning Bolt Sign Appear/Not)

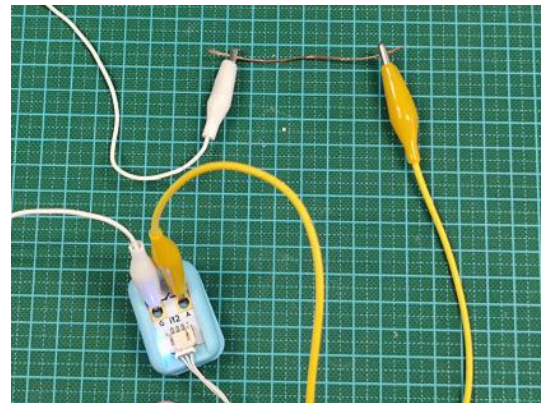

2-2 Clip the two alligator clips onto the two ends of the electrical wire coverings, record the result in the form. (Lightning Bolt Sign Appear/Not)

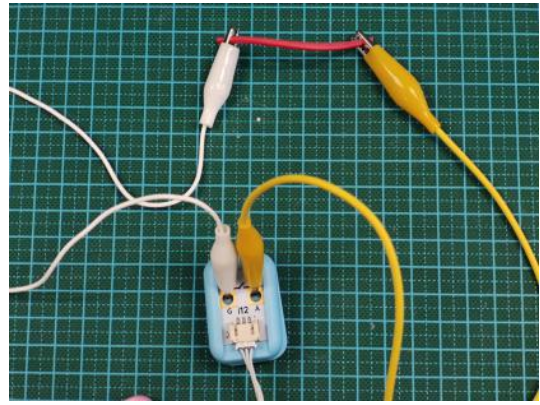

2-3 Hold the two alligator clips with your bare hands, record the result in the form. (Lightning Bolt Sign Appear/Not)

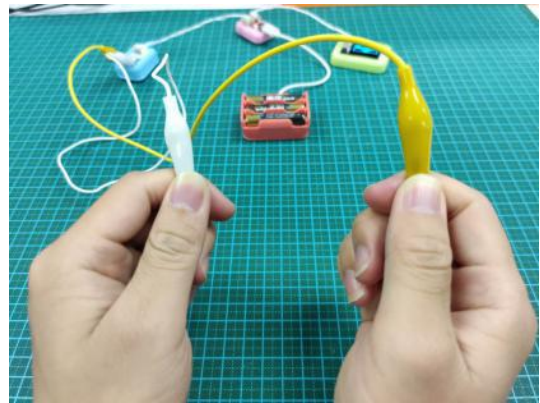

Conclusion

The experiment results are shown below:

Object	Can it transfer power?
Electrical Wire Core	Yes
Electrical Wire Coverings	No
Human Body	Yes

It can be seen from the experiment that only the electrical wire core and human body can transfer electrical power. Did you guess correctly about the previous two questions? Let's check the right answers.

Question 1: What is the function of electrical wire core?	Answer: The electrical wire core is used to transfer electrical power.
Question 2: What is the function of electrical wire plastic coverings?	Answer: The electrical wire plastic coverings cannot transfer power, but electrical power can pass through our bodies. So, the plastic coverings can insulate the metal wire core from human body so as to protect our safety. (When the electricity reaches a certain range, it will cause damage to human body. We only use a very small amount of electricity in the experiments, so no worries.)

Now you must have known why the electrical wires are always covered in plastic.

Science Background

By the experiment we get known that electrical power can pass through some objects like metal wire core, human body. Actually, objects with such properties are called conductors. Conversely, objects that cannot

conduct electricity, like plastic, are insulators. Let's get to know more details about the conductor and insulator!

Conductors & Insulators

Conductors—Some materials let electricity pass through them easily. These materials are known as electrical conductors.

Insulators—Some materials do not allow electricity to pass through them. These materials are known as electrical insulators.

What makes a material a conductor or an insulator? Simply put, electrical conductors are materials that conduct electricity and insulators are materials that do not. Whether a substance conducts electricity is determined by how easily electrons move through it.

Electrical conductivity is dependent on electron movement because protons and neutrons don't move—they are bound to other protons and neutrons in atomic nuclei.



*<https://www.thoughtco.com/examples-of-electrical-conductors-and-insulators-608315>

How the Body Conducts Electricity

So why is electricity so dangerous? Electricity flows from one point to another along anything that will conduct it. One of the better conductive substances for electricity is water, which happens to represent about 70 percent of the human body. But even with all of that water inside of us, electricity doesn't flow through the human body unobstructed. It encounters resistance along the way, which causes some of the energy from the electric current to turn into heat. That heat from resistance causes one of the dangers of electricity: burns.

According to the industry regulations, the safe voltage should not be higher than 36V, and the safe current is 10mA.

Conclusion

In this project, we explored the question about a common phenomenon— “Why are electrical wire covered in plastic?” , and learned what the conductors and insulators are. In fact, there are tons of scientific principles behind our various daily life phenomenon. Go and observe things in your everyday life carefully, you will learn more!

That’ s all for this lesson. Put all Boson modules in the original box.

Extend

The electrical wires we used at home are always wrapped in plastic coverings, but why are the high-voltage transmission lines not wrapped and insulated?



LESSON 2: Why Does the Moon Shine at Night?



Introduction

Standards

NGSS

4-PS4-2 Build a physical model to explain that when the light reflected by an object enters our eyes, the object can be seen.

5-ESS1-2 Present data in charts to illustrate how the length and direction of shadow changes throughout the day, the alternation of day and night, and seasonal changes of stars.





Science - Grade 3-5

Overview

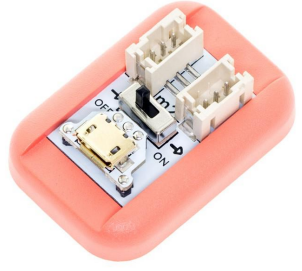

Introduce the light of reflection principle to students starting from the question “Why does the Moon shine at night?” , then lead them to observe the phenomenon of light reflection by experimenting to recognize the nature of light.

Materials

BOSON Module	Image	Function
--------------	-------	----------

<p>Battery Holder</p> <p>(3x AAA batteries installed)</p>		<p>4.5V Power Supply</p>
<p>MainBoard-1IO (m2)</p>		<p>Supply power for other modules</p>
<p>Light Sensor (i4)</p>		<p>Detect the intensity of ambient light</p>
<p>Display Module(o11)</p> <p>*1</p>		<p>Provide visual effect for users to check experiment results</p>
<p>BOSON cable *2</p>		<p>Use with 3Pin Foolproof connector to connect other</p>

		modules
--	--	---------

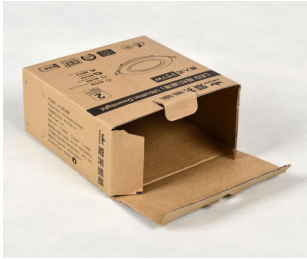
Additional Materials	Image	Function
Flashlight		Light source
White foam ball		Simulate the moon. Recommended diameter: 8-12cm
Paperboard Box		Provide a dark environment for the experiment

Mirror		Provide Mirror and plastic reflective surfaces for experiments
--------	---	--

Engage

We often see the moon shining in the dark sky. The moon itself does not produce any light of its own, but why does it seem bright at night? And if we observe it carefully enough, we can find that the moon is not uniformly bright and there are dark shades all over it. Why is that?

Take a guess!



Explore



After making suppositions about the unknown question, let's test them by experimenting.



The first part of the experiment will mainly explore the question “why does the moon shine at night?” . Then we will move on to the second part to discuss “why the moon is not uniformly bright?” .

Part 1 Why does the moon shine at night?

Preparation



Use a flashlight (can emit light) to simulate the sun, take a white foam ball (cannot emit light) as the moon, and the BOSON light sensor as the human eyes to detect the intensity of light. Observe and think about why the moon shines at night in the experiment.

		
Light Sensor (i4)	Display Module(o11)	MainBoard-1IO (m2)
		
Paperboard Box	Flashlight	White foam ball

 <p>Battery Holder (3x AAA batteries installed)</p>	 <p>BOSON cable *2</p>
--	---

Step

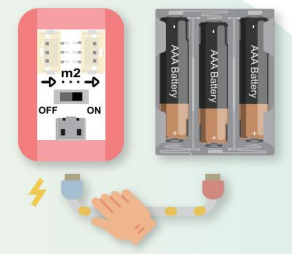
1. Build an experimental circuit to detect the intensity of light using the light sensor.

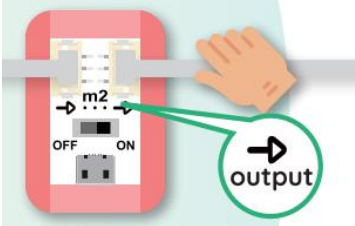
<p>1-1 Connect the Battery Holder and two Module Cables to the Main Board.</p>	  <p>The cable's pin header should be plugged in completely so that it is not easy to pull it out.</p>
<p>1-2 Connect the Display Module to the output side of the Main Board with a Module Cable.</p>	

1-3 Connect the Light Sensor to the input side of the Main Board with a Module Cable.

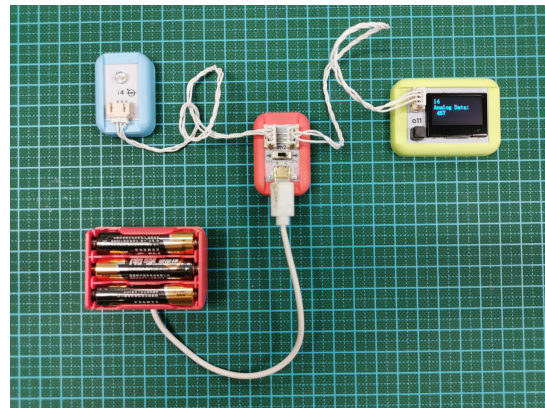

1-4 Build a socket with Lego to fix the light sensor.

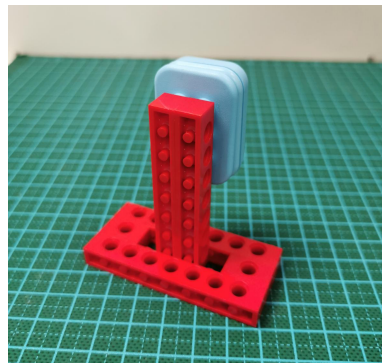

1-5 Switch the Mainboard to ON"

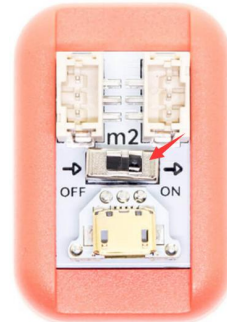

1-6 Press the black button on the module several times until the "i4 Analog Data" is displayed.



2. After the circuit is built, put it in a big paperboard box (if you can complete it in a dark environment, then the box is not necessary), point the round detector of the light sensor at the inner side of

the box, as shown below. It is suggested to fix the light sensor onto the box with adhesive tape to ensure the accuracy of the experimental results.

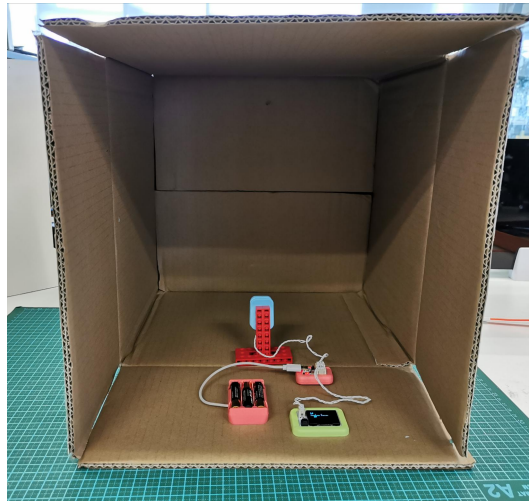

Carry out the three experiments below, and record the results in the form.

2-1 Record the light value displayed on the OLED module.

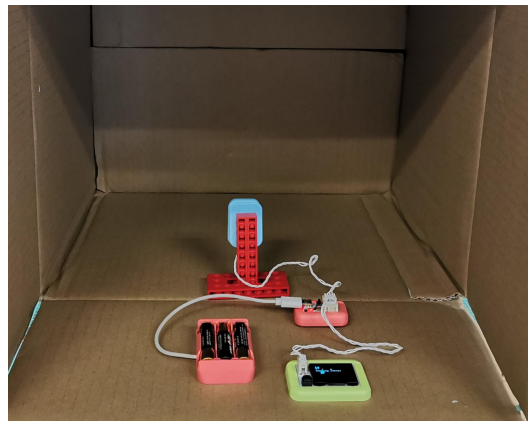

Light value:
(Test result: 23)

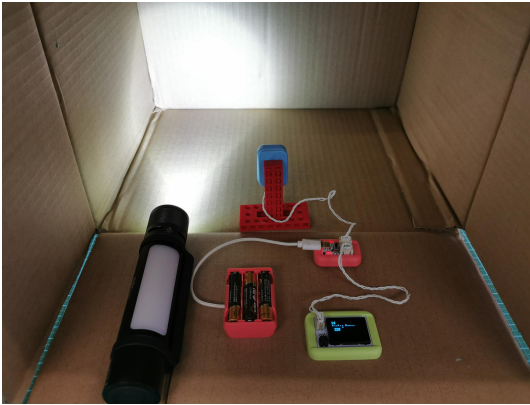
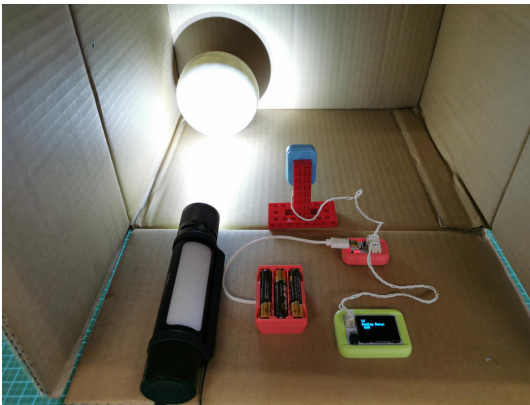
<p>2-2 Put the flashlight behind the light sensor (do not let the flashlight shine directly on the light sensor). Turn on the flashlight and record the light value.</p>		<p>Light value: (Test result: 228)</p>
<p>2-3 Put the white ball in front of the flashlight, and record the light value.</p>		<p>Light value: (Test result: 593)</p>

Activity Conclusion

Imagine, if we do this experiment in a very dark environment, then we can't see anything before the flashlight is turned on.

When turning on the flashlight, the light emitted from the flashlight enters our eyes so we can see it. The foam ball does not produce light,

but it reflects the light of the flashlight into our eyes so it can be seen by us too.

We can see objects that do not produce light because they can reflect light.

For instance, at night, we turn on the lamp for reading. The light from the lamp enters our eyes so we can see it. The book cannot shine, but the lamp' s light shines on the book and is reflected into our eyes by the book, as a result, the book can be seen by us.

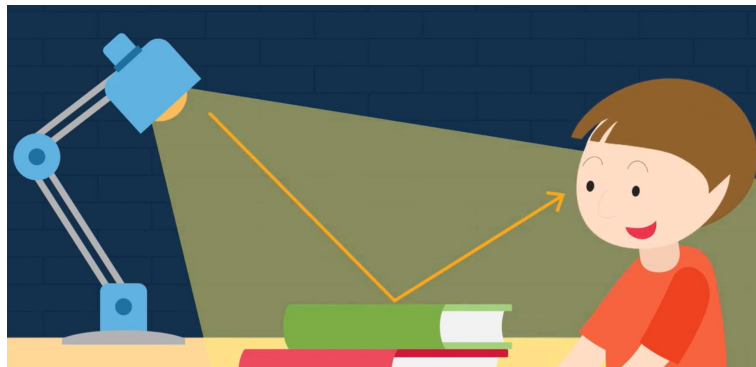

Likewise, the moon itself does not emit light, but its surface reflects light from the sun, so we are able to see it.



Now, you must have known why the Moon shines at night!

Make a Conjecture

In the experiment above, the detected light data becomes larger gradually from the first to the third group.

When the flashlight is turned on, the paperboard box can be seen, indicating that the box can reflect light. After putting the white foam ball inside the box, the detected light value gets larger and the ball looks brighter than the box, from which we can infer that the white foam ball can reflect more lights than the paperboard box.

Do different objects has the same ability to reflect light? In the environment with a same light source, does the object with stronger reflection look brighter?

Then let' s go back to the previous question, why doesn' t the moon seem uniformly bright? Would it have something to do with the surface of the moon? Fill your supposition in the table below:

Question 1: Do different objects has the same ability to reflect light?	Supposition 1:
Question 2: Why doesn' t the moon seem uniformly bright?	Supposition 2:

Part 2 Why doesn't the moon seem uniformly bright?

We can suspect based on the analysis above that the light and dark patches on the moon are related to the different abilities of the moon's surface to reflect light.

To test different objects' ability to reflect light, we can use a mirror to carry out contrast experiments. The two sides of a mirror would be the experimental objects here since they are in the same size, which can avoid the effect of size difference on the light reflection. Complete the experiments below and record the result in the table.

Preparation

The circuit built in the previous experiment will be still used here. The two sides of a mirror will be the experimental objects.





Mirror front side (Metal-coated glass)

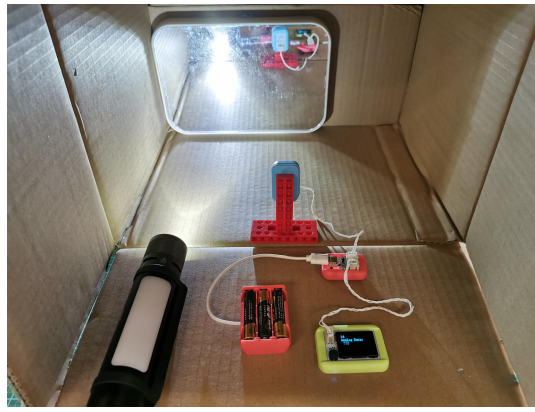

Mirror backside (plastic)

Step

<p>2-1 Let the mirror face the flashlight, record the light value.</p>		<p>Light value: (Test result: 708)</p>
<p>2-2 Let the mirror backside face the flashlight, record the light value.</p>		<p>Light value: (Test result: 291)</p>

Conclusion

The experiments show that the mirror front side performs a stronger ability to reflect light compared with its back side, which states that the light reflection ability of different objects appears to be distinct, and the metal-coated surface can reflect more lights than a plastic surface.

The moon is like a big stone that doesn't shine. The moon's surface had what looked like valleys, plains and highlands much like the distinctly unheavenly surface of the Earth. Moreover, the material composition of these places is also various. The moon highlands are mainly composed of

light-colored rocks, and have a strong ability to reflect sunlight. So, when the sun shines on the highlands, they seem brighter. While the valleys areas are often covered by black volcanic rocks that have a much weaker ability to reflect light. Then, of course, they look much dimmer by contrast.

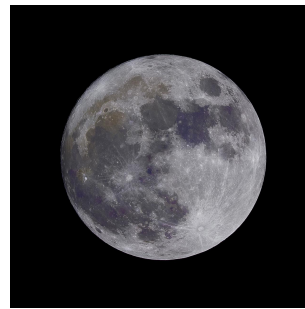
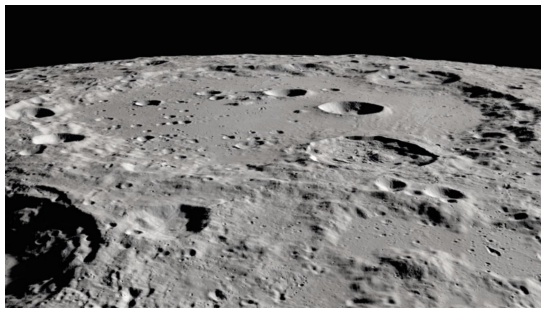

So now you may understand why the moon is not uniformly bright!

Science Background

In our daily life, there are a lot of objects that can make light, and we call them light sources. On the contrary, the objects that cannot produce light themselves are non-light sources. Through the experiments, we learn that human beings can see objects that do not shine by the reflection of light. Now let' s get to know the light sources and non-light sources!

Light Source & Non-light Source

In physics, objects that can make light are called light sources, like the sun, fluorescent bulbs, burning candles, etc. The objects cannot emit light are non-light sources, such as table, chair, wall, paper, etc.

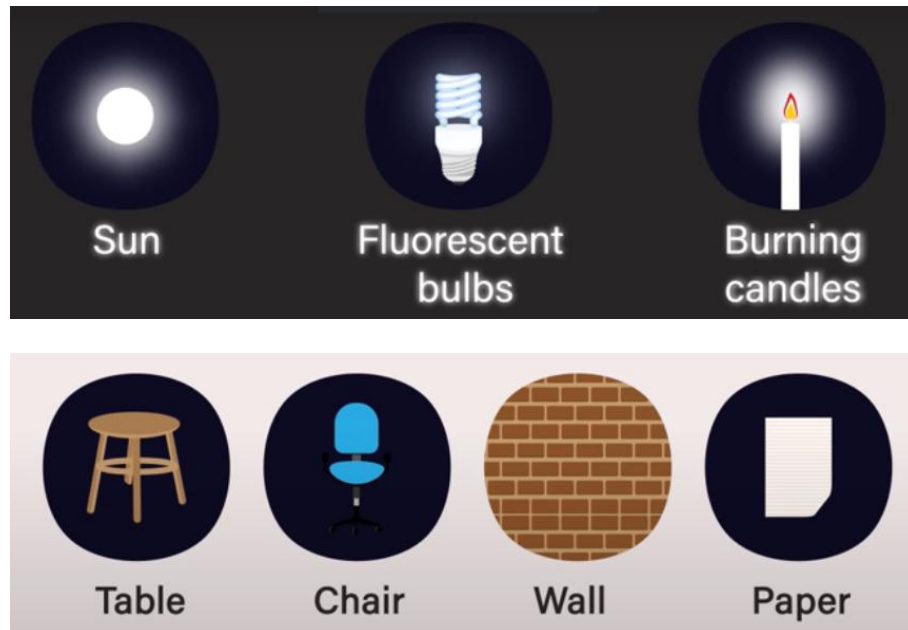

Reflection of Light

Reflection of light is the change in direction of a light ray at an interface between two different media so that the light returns into the medium from which it originated. It is because of the reflection of light that we can see objects that do not emit light.

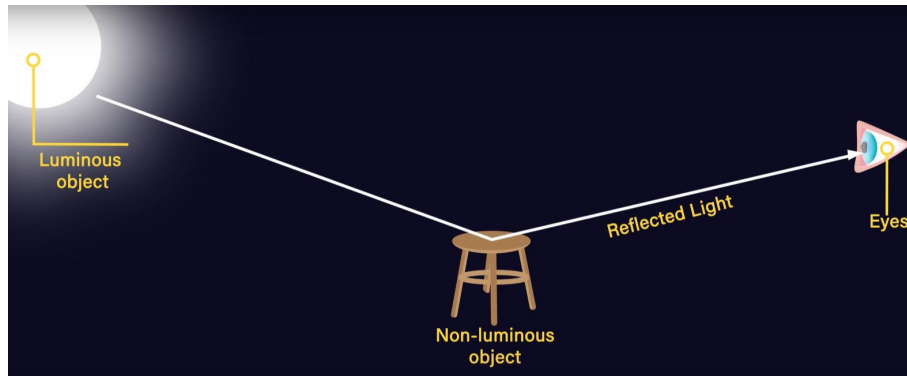

Specular reflection and diffuse reflection

The reflection of light can be roughly categorized into two types: specular reflection and diffuse reflection.

Specular reflection is defined as light reflected from a smooth and shiny surface at a definite angle, for instance, when a light beam falls on a surface like glass, water or polished metal, it reflects at the same time as it hit the surface.

Diffuse reflection is the scattering of light that occurs when it reflects off rough surfaces such as clothes, rocks, etc. Unlike specular reflection, which is calculated based on the surface angle, diffuse reflection is calculated based on the structure of the surface itself. For instance, a rough surface will reflect light at many angles, depending on its bumps, divots, and grain. Even a very smooth surface, like a wall, produces a diffuse reflection at many angles, due to the molecular structure of the material. Diffuse reflection contributes mostly to identifying the object when compared to specular reflection.

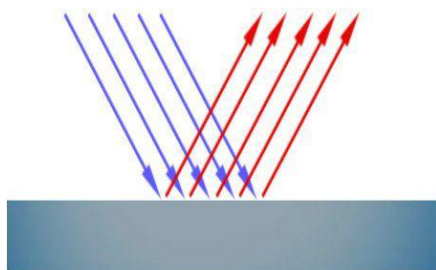

Specular Reflection

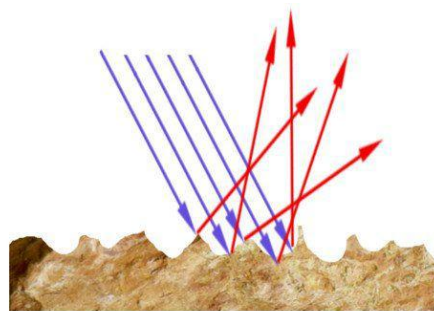

Diffuse Reflection

Specular reflection and diffuse reflection often occur simultaneously. For example, sometimes, we may find the specular reflection on the blackboard since it comes with a very smooth surface, which makes it hard for us to see the contents on it clearly. But, the lights from the diffuse reflection of other objects like, ground and wall, can help us identify the words on the blackboard.



Think about it, when we look in the mirror, what kind of reflection happened? Can you find some specular and diffuse reflection phenomena in our daily life? What are the effects of specular reflection on our everyday life?

Conclusion

In this project, we mainly talk about the question “why does the moon

shine at night?" , and get known to the reflection of light by experimenting, as well as have a rough understanding of the basics of specular reflection and diffuse reflection.

Then that' s all for this lesson. Put all BOSON modules and tools back to the original place.

Extend

1. The moon' s shape appears to be various at different times of a month, why does the moon change shape?



2. It seems that the moon always shows the same side to us, can we see other sides of the moon?

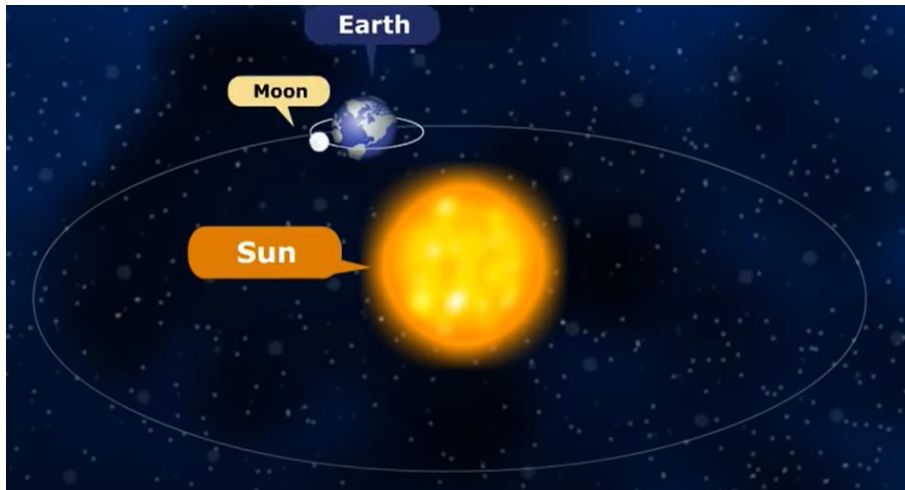

Appendix – Why the moon change shape?

In the universe, the sun is a star, the earth is a planet, and the moon is the permanent natural satellite of the earth. The moon rotates on its axis and revolves around the earth as the earth revolves around the sun. The moon' s period of rotation and revolution are identical. So, one side of the moon always faces the earth.



Although we can only see one side of the moon, the moon may have different "shapes" in a month. It could look like a full circle, a half circle, a crescent, or sometimes it is even invisible. Why is that? Let' s find out the answer through a simple experiment.

First, find a dark room (the darker, the better) to simulate the cosmic environment, prepare a table lamp to simulate the sun, think of our own head as the earth, and a white foam ball as the moon. Then the "Sun-Earth-Moon" models are corresponding to the "lamp-head-foam ball".

		
Lamp	White foam ball	Pencil

Step

1. Carefully pierce the ball with the pencil, and hold it with your one hand.
2. Stand with the white ball at arm's length in front of the sun(lamp), and keep turning to the left slightly to simulate that the moon(ball) rotates around the earth (your body).



3. The lamp is the model of the sun. Keep turning your body to the left while observing how the lighted portion of the ball looks at different positions.

	Your positions	

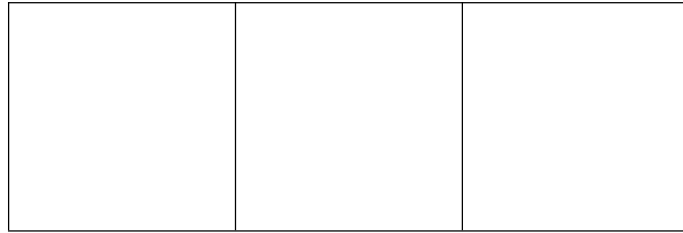

* Video for reference:

<https://www.youtube.com/watch?v=wz01pTvuMa0>

Conclusion

We have known that the moon shines because its surface reflects light from the sun. In this experiment, as the moon orbits the Earth, we see the different parts of the lighted area. The revolution of the Moon around the Earth makes the Moon look as if it is changing shape in the sky. These are called phases of the Moon. Refer to the figure below to see if the results of your observation are consistent with the moon phase chart!

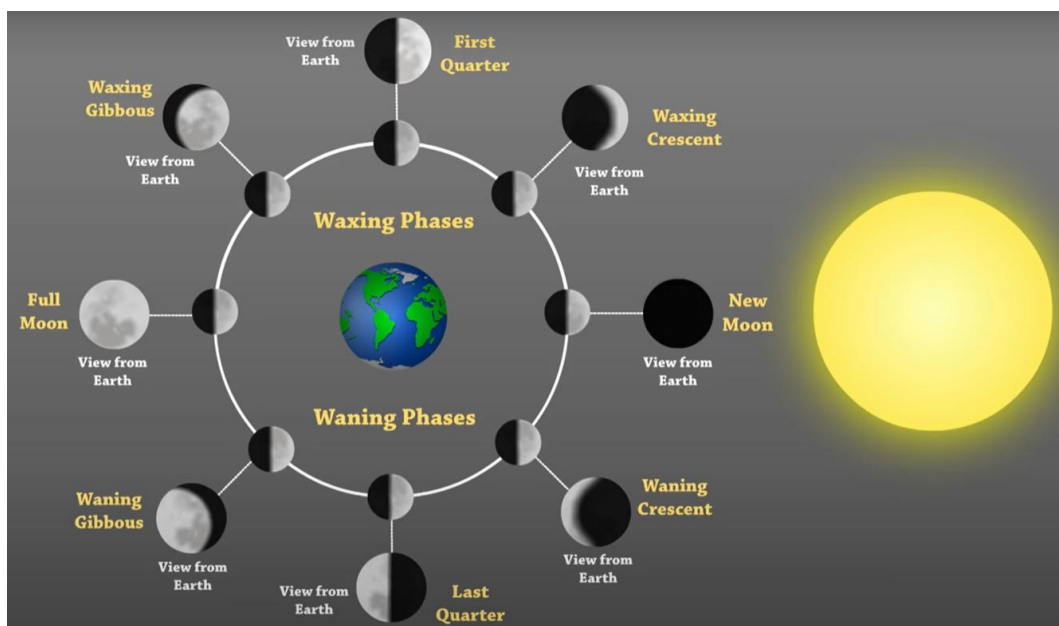

LESSON 3: How to Make Your Living Room Comfortable?



Introduction

Standards

NGSS

5-PS1-3 Make observations and measurements to identify materials based on their properties.





4-PS3-2 Make observations to provide evidence that energy can be transferred from one place to another via sound, light, heat, and current.

Science - Grade 3-5





Overview



There are many types of materials used in construction and their thermal insulation capacities are various. What materials are best for building a comfortable house? In this lesson, we will mainly explore the thermal insulation performance of wood, plastic, and metal so as to introduce the concept of heat, leading students to find out which kind of material has better thermal insulating performance as well as get to know the basics about heat transfer.

Materials

BOSON Module	Image	Function
Battery Holder (3x AAA batteries installed)	 An orange plastic battery holder designed for three AAA batteries. It has a white USB-A to micro-USB cable attached to the side.	4.5V Power Supply
MainBoard-1IO (m2)	 A small electronic module with a white PCB, mounted on an orange plastic case. It features several pins and a small component on the board.	Supply power for other modules
Temperature Sensor (i11)	 A small electronic module with a white PCB, mounted on a light blue plastic case. It features a black sensor component and a yellow connector.	Detect environmental temperature
Display Module(o11)	 A small electronic module with a white PCB, mounted on a light green plastic case. It features a small black display screen and a yellow connector.	Provide visual effect for users to check experiment results

BOSON cable *2		Use with 3Pin Foolproof connector to connect other modules
----------------	---	--

Additional Materials	Image	Function
Wooden Cup		Used for exploring the thermal insulation performance of wood
Plastic Cup		Used for exploring the thermal insulation performance of plastic
Metal Cup		Used for exploring the thermal insulation performance of metal
Blu-Tack		Fix the temperature sensor

Cup Cap x3		Cover the cups
Ice blocks		Temperature Experiments

Engage

Whether it's in the hot equatorial region or the cold Arctic, people all want a very comfortable indoor temperature. Imagine that we have just arrived at a deserted tropical island, where the scenery is beautiful, but it's pretty hot... There are three kinds of materials on the island that can be used to build a house: wood, plastic and metal sheet. If we want to live in a cool and comfortable house, which one should we choose? Take a guess!



Explore

The thermal insulation performance is closely related to the transfer speed of heat. The better the thermal insulation effect, the slower the heat transfer speed. Will the three materials wood, plastic and metal transfer heat at the same speed?

This lesson mainly contains two parts: 1. Feel the temperature of the three materials by touching. 2. Use the BOSON temperature sensor to explore the thermal insulation capacity of the three materials so as to find out the most suitable one for building a house.

Part 1 Observation: Which material feels colder?

It is known that in winter, metal feels colder than plastic and wood, while in summer, it feels hotter than the latter two materials. Why is that?

If we put a piece of ice in a wooden cup, a plastic cup and a metal cup, which will feel colder after keeping still for a while?

Material



Step

<p>1. Put three ice blocks of the same size into the plastic cup, wooden cup and metal cup respectively.</p>	
<p>2. Put the three cups at the same indoor temperature, and keep still for 5 minutes(Do not touch them within this time)</p> <p>Note:</p> <p>If the experiment is carrying out in summer with high temperature, then shorten the experiment time in case the ices melt completely.</p>	
<p>3. After 5 minutes, touch the outer wall of the plastic cup and the wooden cup with both hands to see which cup feels colder.</p>	
<p>4. After the temperature of your both hands back to normal, touch the outer wall of the wooden cup and metal cup to see which cup</p>	

feels colder.	
---------------	--

Conclusion

The experiment shows that the metal cup feels colder than the other two cups, which indicates that metal has the fastest heat transfer speed among them. Wooden cups and plastic cups feel almost the same, so they transfer heat at about the same rate.

Make a Conjecture

When building a house, which kind of material should we choose to achieve better thermal insulation performance? Take a guess!

Part 2 Measurement: The thermal Insulation Performance of different material

In this experiment, we need a wooden cup, a plastic cup and a metal cup with similar volume and thickness, put ice blocks of the same size into each cup, and then use the BOSON temperature sensor to measure the temperature change of the three cups. Present the thermal insulation capacity of the three materials by the experimental data and record values in the table below.

Time Material	0min	10min	20min	30min
Plastic Cup				



Wooden Cup				
Metal Cup				

Note:

If the experiment is carrying out in summer with high temperature, then shorten the experiment time in case the ices melt completely.

Material

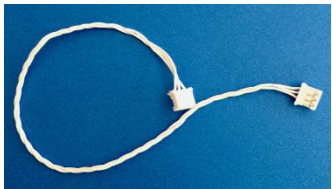
Prepare the following BOSON modules and other materials.

 <p>Display Module(o11)</p>	 <p>MainBoard-1IO (m2)</p>	 <p>Temperature Sensor (i11)</p>
 <p>Battery Holder (3x AAA batteries installed)</p>		 <p>BOSON cable *2</p>
 <p>Wooden Cup</p>	 <p>Plastic Cup</p>	 <p>Metal Cup</p>

 <p>Blu-Tack</p>	 <p>Cup Cap x3</p>	 <p>Ice Blocks</p>
---	---	---

Step

1. Build an experimental circuit to detect the environmental temperature.

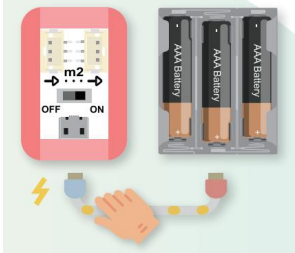
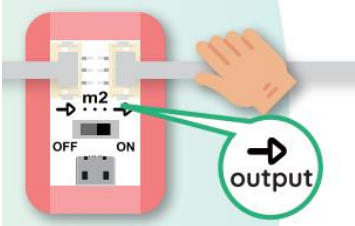
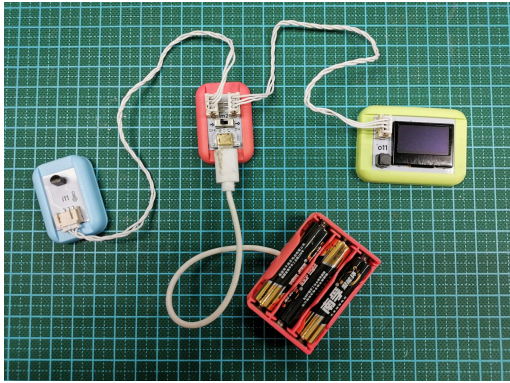
<p>1-1 Connect the Battery Holder and two Module Cables to the Main Board.</p>	 <p>The cable's pin header should be plugged in completely so that it is not easy to pull it out.</p>
<p>1-2 Connect the Display Module to the output side of the Main Board with a Module Cable.</p>	
<p>1-3 Connect the Temperature Sensor to the input side of the Main Board with a Module Cable.</p>	

1-4 Switch the Mainboard to "ON" .

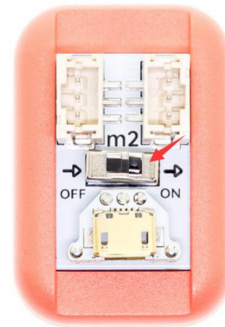

1-5 Press the black button on the module several times until the "i11 temperature" is displayed.



2. When the circuit is built, complete the following steps.

2-1 Fix the BOSON temperature sensor on the inner wall of the metal cup with Blu-Tack.

Note: Fix the sensor at a suitable height. The cup cap should be able to be covered properly and make sure the sensor will not be immersed and damaged by water when the ices melt.



2-2 Put three ice blocks into the metal cup, put the lid on it. Record the temperature at 0min, 5min, 10min and 15min, as shown in the table below.

Note: To ensure the accuracy of the result, the cup should be covered by the lid all the time during the experiment period.



2-3 Change the metal cup into the plastic cup and wooden cup, repeat the above two steps, and record the experimental data.



Tip: In the actual experiment, for saving time, teachers can arrange three groups of students to choose different materials and do the experiment at the same time, and then summarize the data in one table.

Conclusion

The reference experiment data are shown below(at indoor temperature 20°C):

Time	0min	10min	20min	30min
------	------	-------	-------	-------

Material				
Plastic Cup				
Wooden Cup				
Metal Cup				

The experimental data shows that, for the heat transfer performance: metal > wood > plastic, which also means, for material thermal insulation capacity: metal < wood < plastic.

Now, do you know what material we should choose to build a house?

Science Background

From the experiment, we get known to the thermal insulation of material, also heat transfer performance. Next, we will get into more details about how heat is transferred.

How is heat energy transferred?

Take wood and metal as examples. In a cold winter, the temperatures of wood and metal outdoors are almost the same as the ambient temperature.

When we touch metal, since our hand is warmer than the metal, the heat will be transferred from the hand to the metal. Metal material transfers heat so quickly that when the heat is just transferred to the part where our hand touches the metal, it will be transferred out by other parts of the metal, which will make us feel cold when touching it.

When touching a wood, similarly, that heat will be transferred from the hand to the wood because its temperature is higher than the latter. The difference is that, since the wood transfers heat slowly, the heat absorbed by the wood will accumulate at the part where our hand touches the wood, as a result, it does not feel so cold compared with the metal.

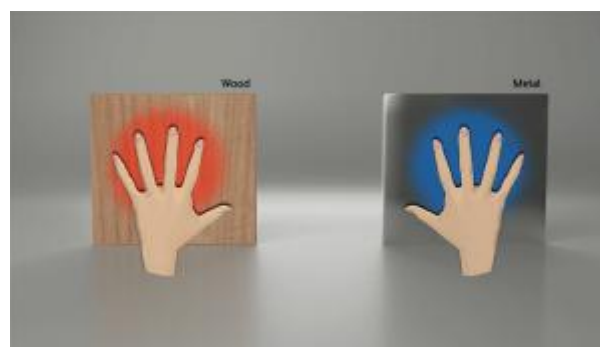

Good Conductor and Poor Conductor of Heat

Metals are called good conductors of heat since they can speedily transfer heat, whereas materials that transfer heat slowly like wood, plastic, paper, air, and cloth are poor conductors of heat.

Metals among solids are good conductors of heat, such as silver, copper and aluminum. Other solids are mostly poor conductors of heat, such as stone, ceramics, glass, wood, etc. And materials like, wool, feathers, fur, cotton, asbestos have very poor heat transfer performance, which can save the heat emitted by the human body and keep the body warm. So people often wear cotton-padded clothes, sweaters or down jackets in winter.

Conclusion

In this project, we explored the scientific principle behind the common phenomenon “Why do metals feel colder than plastic” , finished the research experiment using the BOSON temperature sensor, and learned the basics about good conductors and poor conductors of heat. So the question at the beginning of this lesson can be answered now.

That’ s all for this lesson. Please put all BOSON modules into the original box.

Extend

Many mugs are made of stainless steel, why do they still have such a good thermal insulation effect?



Lesson 4: Does the Car Sun Shield Really Work?



Introduction

Standards

NGSS

4-PS3-2 Make observations to provide evidence that energy can be transferred from one place to another via sound, light, heat, and current.

4-PS3-4 Design, test, and optimize a device that can convert energy form from one to another based on scientific conception.

Science - Grade 3-5





Overview

In summer, our cars always get hot easily. How can we solve this problem?



In this lesson, starting with this common phenomenon, we are going to test whether a sun shield is effective in shading and insulating the heat from the sun, and review the knowledge about heat transformation.



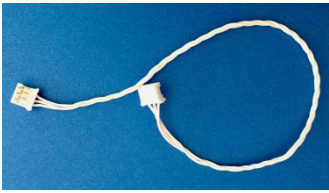

Then, we are going to study which of the three materials, aluminum foil, corrugated paper and black EVA sponge paper, is more suitable for making sun shields for cars, so that we can learn the energy transformation process and the knowledge of thermal radiation.

Materials

BOSON Module	Icon	Function
Battery Holder (3x AAA batteries installed)		4.5V Power Supply
MainBoard-1IO (m2)		Provide power for other modules
Temperature Sensor (i11)		Measure the environment temperature
Display Module(o11)		Provide visual effect for users to check experiment results

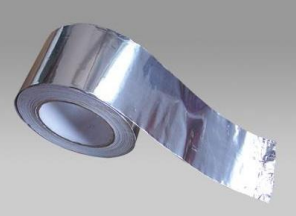
BOSON cable *2		Cooperate with 3Pin Foolproof interface to connect each module

Additional Materials	Icon	Function
Warm-light Lamp		Generate heat and light as the sun (be sure not to use cold-light lamps, because they only generate light but no heat)
Plastic Box		It is used to simulate the vehicle. A glass one is also okay. (smaller one is recommended for a

		better effect)
Aluminum Tape		It is used to make the sun shield. You can also choose household aluminum foil
Corrugated Paper		It is used to make the sun shield. Its thickness is 2mm or so
Black EVA Sponge Paper		It is used to make the sun shield. Its thickness is 2mm or so
Paper Knife		Cut the paper
Blu Tack		Fix the sensors and the materials

Engage

Sunlight is everywhere, and we can't live without it. But sometimes, it may also be annoying. For example, in open parking in summer, after continuous exposure to the sun, the car will be super-hot, like an oven. Every time you enter the car, you will feel like entering a sauna!

Many people have come up with many methods, such as turning on the AC to cool down in advance, or opening the door to have ventilation, while some people put a sun shield made of tin foil in front of the windshield to block out the sunshine and cool the car down.



Do you think sun shields really work? Why are sun shields usually made of tin foil? If there is aluminum-foil paper, corrugated paper, black EVA sponge paper to be chosen, which one do you think is the best? Make a guess!

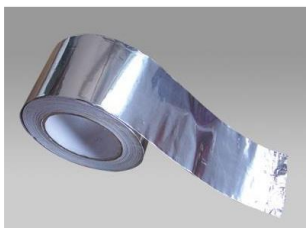

Explore

We have already made a guess about the above two questions, now let's check it out!

The experiment will be divided into two parts. In the first part, the BOSON temperature sensor will be used to test whether the sun shield has a cooling effect through comparative experiments. In the second part, we will explore the cooling effect of aluminum aluminum-foil paper, corrugated paper and black EVA sponge paper respectively, and select materials more suitable for making sun shield.

Part1 Does Sun Shield Really Work?

In order to explore whether the sun shield really works, we can study it in real life. For example, find two vehicles, one with sun shield, while the other without. Carry out experiments under the same sunlight to compare the temperature changes inside the two vehicles.

With some simple materials, we can simulate this scenario. For example, take a lamp as a light resource, turn a plastic box upside down to simulate vehicle (plastic box can be used to simulate the enclosed interior of a vehicle), foil tape as a simple sun shield. We can carry out two groups of the controlled experiments, and draw conclusions through the comparison of temperature changes.

Record the value of temperature in the table below!

Exposure Time	0min	5min	10min	15min	20min
No Aluminum-foil paper					
With Aluminum-foil paper					

It is suggested to guide the students to draw data into a line graph manually.

In the **line graph**, the horizontal line refers to time, while the vertical line refers to temperature. When drawing, mark the measured temperature values with points, and finally connect the points together in turn with a smooth curve. Distinguish the temperatures of different conditions with different colored lines, as shown in the figure below.

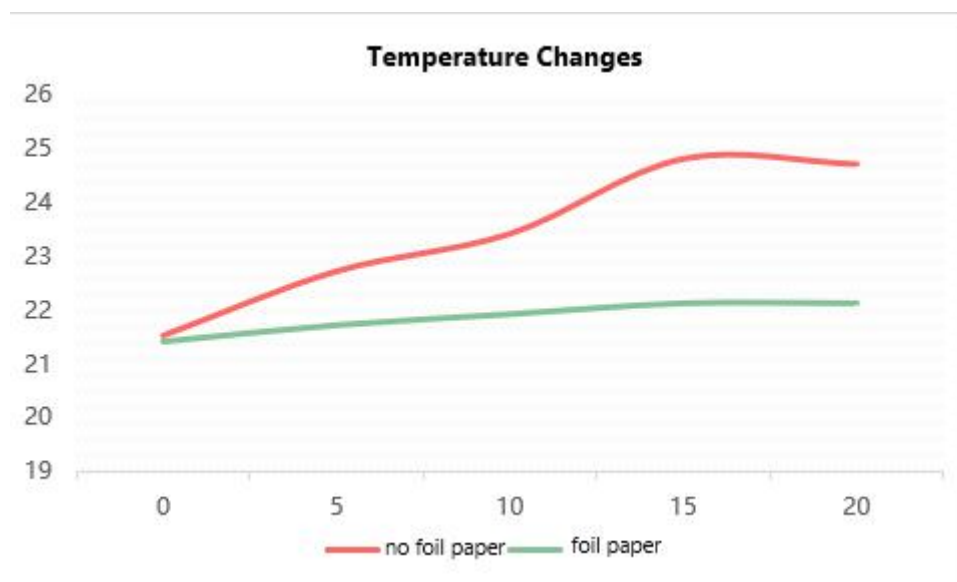

Materials

Prepare the BOSON module and other materials below.



Display Module(o11)



MainBoard-1IO (m2)



Temperature Sensor (i11)



Battery Holder (3x AAA batteries installed)

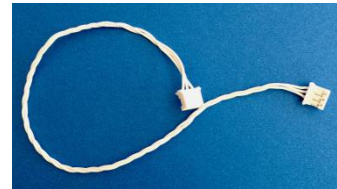

BOSON cable *2



Warm-Light Lamp



Plastic Box

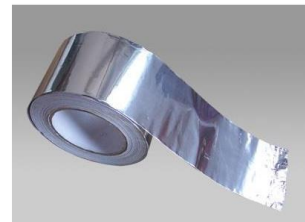

Aluminum-Foil Tape



Blu Tack



Paper Knife

Step

1. Build an experimental circuit to measure the environmental temperature

1-1 Connect the battery holder and two module cables to the main board.



1-2 Connect the display module to the output side of the main board with a module cable.

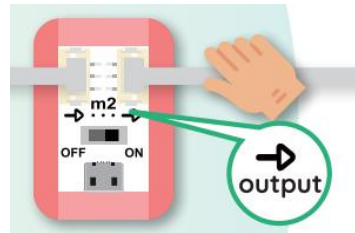

1-3 Connect the temperature sensor to the input side of the main board with a module cable.



1-4 Switch the Mainboard to "ON" .

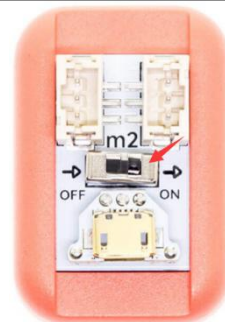

1-5 Press the black button on the display module several times until "i11 Temperature" is displayed.



2. Continue the following steps after finishing connecting the circuit. Set two groups of experiments, one with aluminum-foil paper and the other without. Illuminate them with strong light, and then record the temperature changes of the two groups.

2-1 Fix the BOSON temperature sensor with blue tack and place the plastic box upside down to cover the temperature sensor.

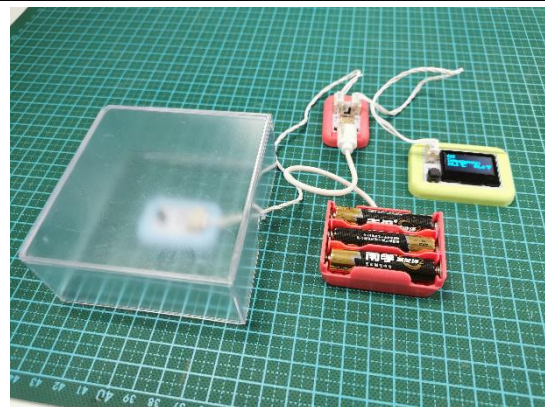

2-2 Point the lamp as close as possible to the top of the plastic box and turn on the lamp.

According to the time in the previous table, record the temperature values of 0min, 5min, 10min, 15min and, 20min successively.

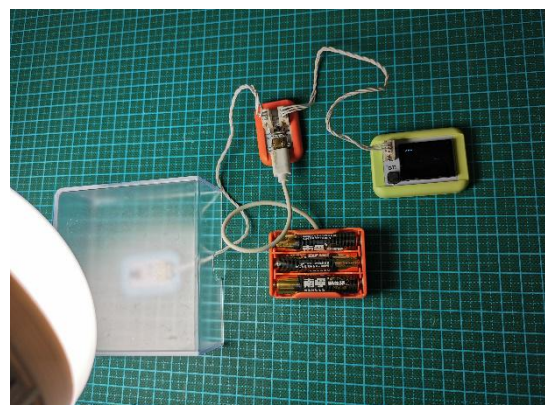

(Do not move the position of the light source or the sensor during the experiment to avoid inaccurate experimental data)

2-3 Turn off the lamp, wait for 5-10 minutes to let the temperature sensor value return to room temperature. Use a paper knife to cut the foil tape into the size of the top of the plastic box.

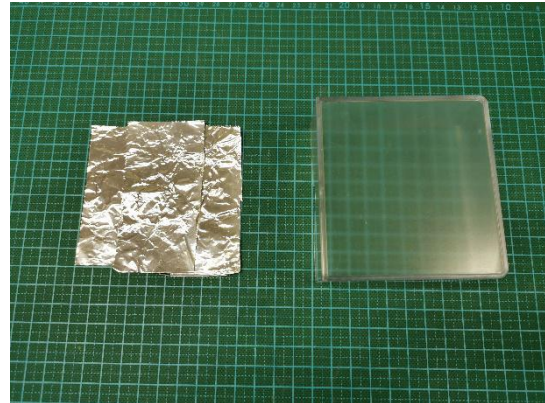

2-4 Cover the foil on the top of the box, turn on the lamp and record the temperature values of 0min, 5min, 10min, 15min, 20min. (Do not move the position of the light source or the sensor during the experiment to avoid inaccurate experimental data)

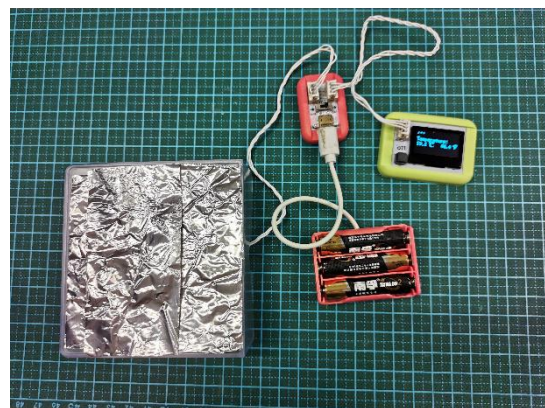

In the actual experiment, we can use two sets of equipment to carry out two groups of experiments at the same time, saving experimental time.

Conclusion

The referable experimental data are as follows (in the actual experiment, the room temperature is around 21°C):

Exposure Time	0min	5min	10min	15min	20min
No Aluminum-foil paper	21.5°C	22.7°C	23.4°C	24.8°C	24.7°C
With Aluminum-foil paper	21.4°C	21.7°C	21.9°C	22.1°C	22.1°C

The referable line chart is as follows :

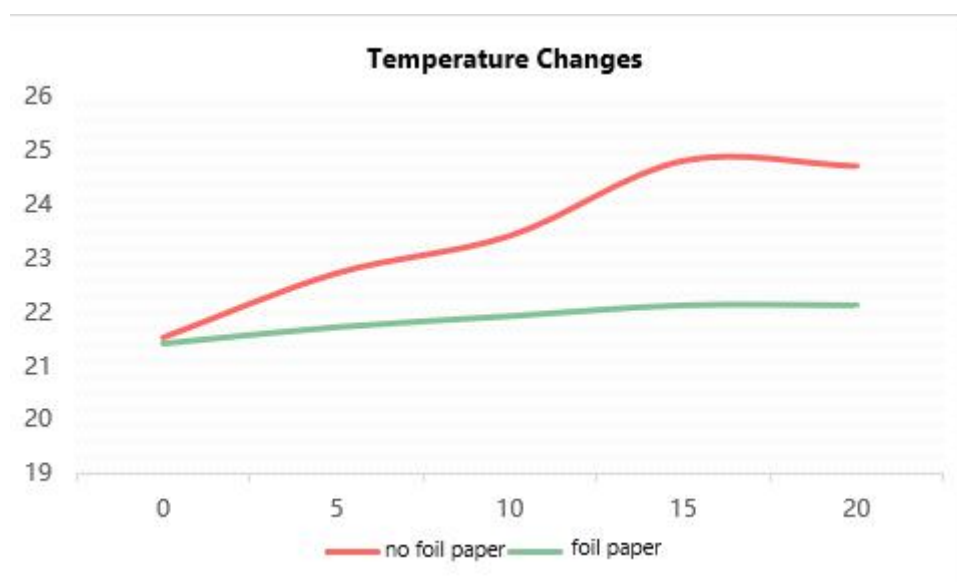

It can be clearly informed from the line graph that when there is no aluminum-foil paper, the temperature rises all the time. After adding aluminum-foil paper, the temperature rises very slowly. Therefore, we can conclude that aluminum-foil paper does play a cooling effect, which means the sun shield really works.

Actually, a sun shield is just like a person with a sun umbrella. By blocking

part of the light, the heat from the sun cannot be directly transferred to the covered object, so it plays a role in heat insulation. However, when the sun is very strong or the object is illuminated for a long time, do you think the sun shield is still useful?

Part 2 What Materials Should the Sun Shield Be Made of?

In the above experiment, we learned that sun shields do have a cooling effect, so what would be a better material to use to make them? Here we will explore the cooling effect of aluminum-foil paper, corrugated paper and black EVA sponge paper, and select the most suitable material.

On the basis of Part 1 experiment, only two groups of the controlled experiments with corrugated paper and black EVA sponge paper are needed. Record the data in the table below.

Exposure Time	0min	5min	10min	15min	20min
No Aluminum-foil paper					
Aluminum-foil paper					
Corrugated Paper					
EVA Paper					

Draw the data into a line chart for easy comparison.

Materials

On the basis of Part 1 experiment, add the following materials.



Step

1 Use a paper knife to cut corrugated paper and black EVA sponge paper into the top size of the box.

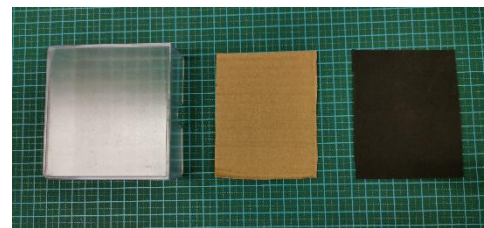

2 Cover the corrugated paper on the top of the box, turn on the desk lamp and record the temperature values of 0min, 5min, 10min, 15min, 20min. (Do not move the position of the light source or the sensor during the experiment to avoid inaccurate experimental data)

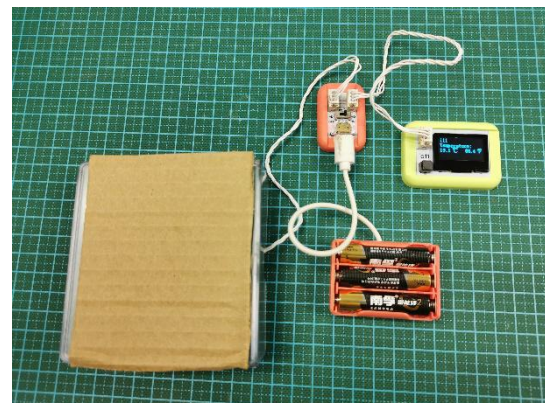

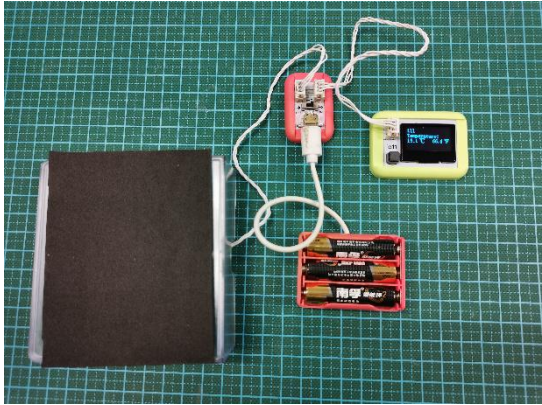
<p>3 Turn off the lamp, wait for 5-10 minutes to let the temperature sensor value return to room temperature.</p>	
<p>4 Cover the black EVA sponge paper on the top of the box, turn on the desk lamp and record the temperature values of 0min, 5min, 10min, 15min, 20min. (Do not move the position of the light source or the sensor during the experiment to avoid inaccurate experimental data)</p>	

In the actual experiment, we can use two sets of equipment to carry out two groups of experiments at the same time, saving experimental time

Conclusion

The referable experimental data are as follows (in the actual experiment, the room temperature is around 21°C):

Exposure Time	0min	5min	10min	15min	20min
No Aluminum-foil paper	21.5°C	22.7°C	23.4°C	24.8°C	24.7°C

Aluminum-foil paper	21.4°C	21.7°C	21.9°C	22.1°C	22.1°C
Corrugated Paper	21.5°C	22.1°C	22.5°C	22.7°C	23.0°C
EVA Paper	21.5°C	22.3°C	23.1°C	23.6°C	24.2°C

The referable line chart is as follows :

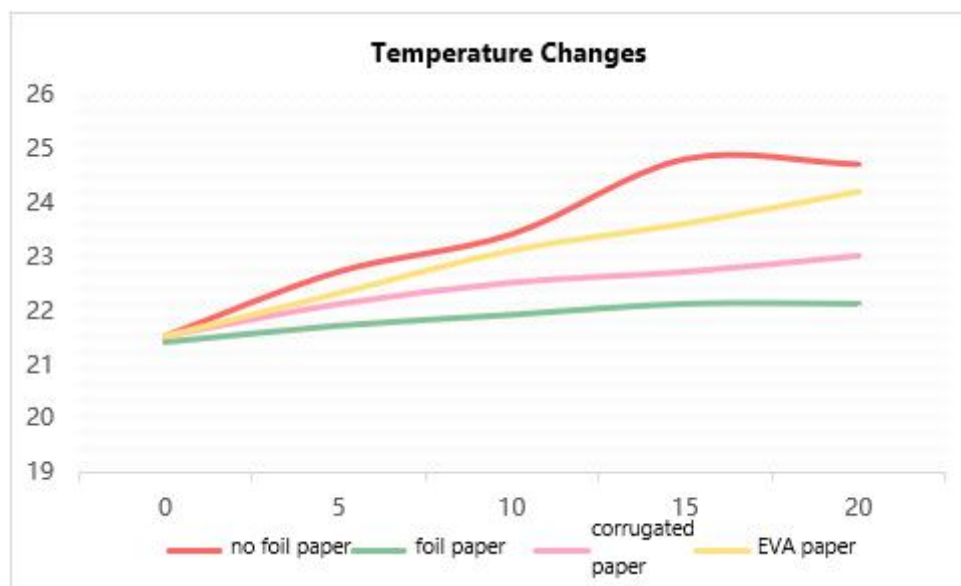

Analyze the line chart, which material do you think is the best for making sun shields?

Think about why different materials are with different effects? Try to explain it from the perspective of light reflection.

Science Background

The sun brings warmth and light to the earth. It provides the earth with endless energy. That's why life on earth keeps growing. Do you know what energy is? Let's learn it together!

What Is Energy?

Energy is a basic physical concept, and it is also a very abstract concept. In the world, all things are in constant motion with various forms of motion. For every specific form of motion, there is corresponding form of energy, such as chemical energy of objects, heat energy of objects, radiation energy of sunlight, nuclear energy and so on.

Almost all the energy on the earth comes from the sun. The sun is like a big fireball with an extremely high temperature. Nuclear fusion is going on inside the sun, creating huge amounts of energy that radiates outward through the sun's rays and reaches the earth.

Energy is convertible, such as power plants that burn coal to convert chemical energy into electricity, or solar water-heaters that convert radiant energy from sunlight into heat energy from water.

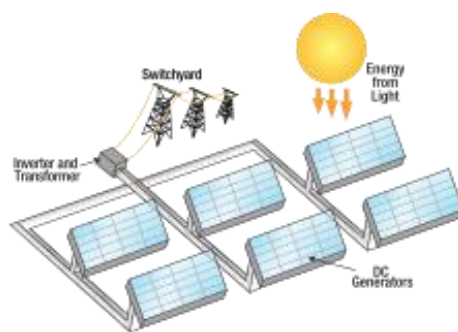

What Is Radiation?

Radiation is short for thermal radiation. It refers to the phenomenon that an object emits light and heat due to its temperature. Anything above absolute zero produces thermal radiation. The higher the temperature,

the stronger the radiation.

Some light emitted by thermal radiation is visible to the naked eye, while the other invisible. Human body temperature is lower, radiates invisible infrared light, with very low energy. The sun is very hot, radiates a lot of light, and it's with high energy.



Why use aluminum-foil paper to make sun shield of a car?

When light hits on an object, three things happen: part of the light can be absorbed by the object, part of the light can be reflected by the object, and part of the light can continue to spread through the object.

The light absorbed by the object is converted into heat energy, which heats up the object.

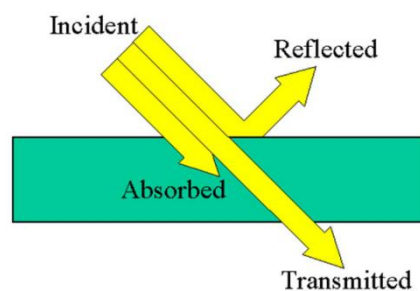

Aluminum-foil paper, corrugated paper, and black EVA sponge paper reflect light differently. Aluminum-foil paper, which reflects light very well, with less light absorption and slow heating, is suitable for sun shield.



Three ways of transferring heat

Heat radiation is one of the three ways in which heat is transferred, as well as by thermal conduction (conduction for short) and thermal convection (convection for short). As long as there is a temperature difference within or between objects, heat energy is bound to transfer from high temperature to low temperature in one or several of three ways. Here is an example.

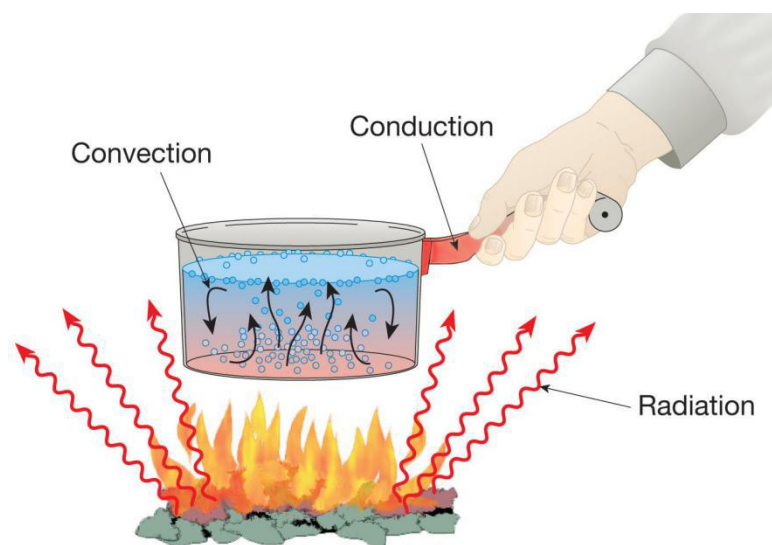

Thermal conduction refers to the transfer of heat from a hotter object to a cooler one, such as touching the handle of a pot.

Thermal convection refers to the transfer of heat by the flow of the liquid or gas, such as the circulation of water in boil.

Thermal radiation refers to the electromagnetic waves radiated by objects because of their temperature. For example, when you are near a fire, you feel warm.

Both thermal convection and conduction require contact. Since there is a vacuum between the earth and the sun, the sun transmits heat to the earth through thermal radiation.

Conclusion

In this project, we started our exploration from a common phenomenon in life: Do car sun shields really work? We used the BOSON temperature sensor for scientific experiments, and drew the conclusion. We also further explored the cooling effect of three kinds of material: aluminum-foil paper, corrugated paper, and black EVA sponge paper, to help us choose the most suitable one for making car sun shields. Besides, we studied relevant knowledge of the thermal radiation as well.

The project is going to an end, please remove cables, and put all the BOSON modules back into the original position of the kit.

Extent

1. Do you think the sun shield should be put inside or outside the car?



2. Why can we warm ourselves with a heater in winter? Can you tell the scientific principles behind it?



LESSON 5: Why Is It Summer After Spring ,not Winter?



Introduction

Standards

NGSS

4-PS3-2 Make observations to provide evidence that energy can be transferred from one place to another via sound, light, heat, and current.

3-ESS2-1 Present data in charts to describe the expected typical weather conditions in a specific season.





5-ESS1-2 Present data in charts to illustrate how the length and direction of shadow change throughout the day, the alternation of day and night, and seasonal changes of certain stars.

Science - Grade 3-5

Overview

This lesson will mainly focus on seasonal alternation, discussing the question "why is spring followed by summer, not winter?". It will lead students to construct a simple "earth-sun" model to explore the distribution of sunlight on the earth, study the direct and oblique light knowledge, and learn the revolution of the earth and the formation of the four seasons.

Materials

BOSON Module	Image	Function
Battery Holder (3x AAA batteries installed)	 An orange plastic battery holder designed for three AAA batteries. It has a white USB-A to micro-USB cable attached to the side.	Provide power of 4.5V
MainBoard-1IO (m2)	 A small electronic module with a white PCB, mounted on an orange plastic case. It features several headers and a micro-USB port.	Provide power for other modules
Light Sensor (i4)	 A small electronic module with a white PCB, mounted on a light blue plastic case. It features a yellow header and a circular sensor component.	Measure the intensity of ambient light
Display Module(o11) *1	 A small electronic module with a white PCB, mounted on a light green plastic case. It features a small LCD display screen and a black push-button.	Provide visible effect for other modules, make it easy to check the result

BOSON cable *2		<p>Cooperate with 3-Pin fool-proofing interface to connect modules</p>
----------------	---	--

Additional Materials	Image	Function
Flashlight		Light source
Globe		Model of the earth
LEGO Blocks		Set up a base for the flashlight
Blu Tack		Fix the sensors and the materials

Engage

In most places on the earth, people experience spring, summer, autumn and winter every year. Do you feel the differences between different seasons?

We feel different temperature during different seasons. The climate is pleasant in spring and autumn, hot in summer and cold in winter. Think about it, why are there four seasons in a year? Why is it summer after spring, not winter?



Explore

Last lesson, we talked about how the sun brings light and heat to the earth, and makes the earth full of vigor. Think about it, does the

distribution of sunlight on the earth vary during the year? Let's perform an experiment to find it out!

This experiment will be divided into two parts. The first part is to learn the direct and oblique light, and the second part is to explore the distribution of the direct and oblique light of the sun on the earth.

Part 1 Observation: Direct and Oblique Light

The effect is different when the light hits at different angles. A beam of light that shoots vertically is called direct light, and one that shoots at an oblique angle is called oblique light.

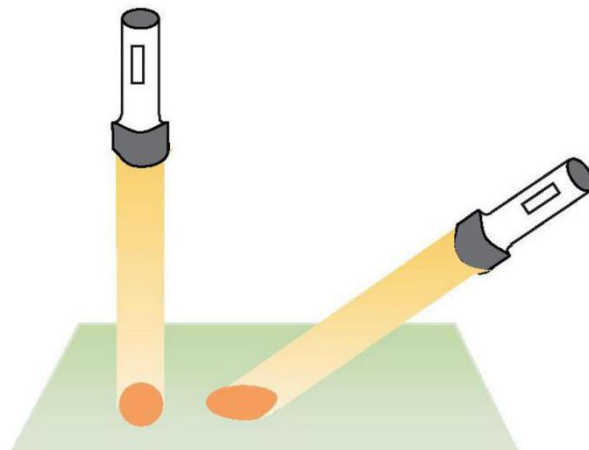

What is the difference between direct and oblique light? Try filling in your guess in the table below.

	Light (Concentrated/Scattered)	Temperature (High/Low)
Direct		
Oblique		

Materials

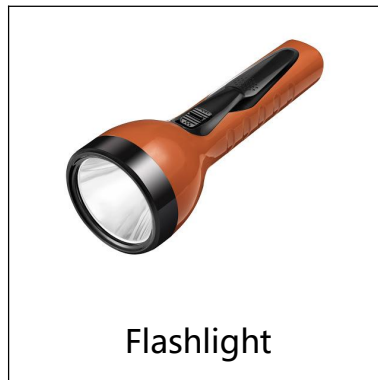

Step

Let us observe the direct and oblique light with a flashlight. The operation is as follows.

1-1 Illuminate the flashlight vertically on a flat surface and observe the size of the aperture of the direct light.

We can also draw the aperture on the paper, so that we can compare and observe easily.



1-2 Tilt the flashlight gradually and observe the change in the aperture of the oblique light.



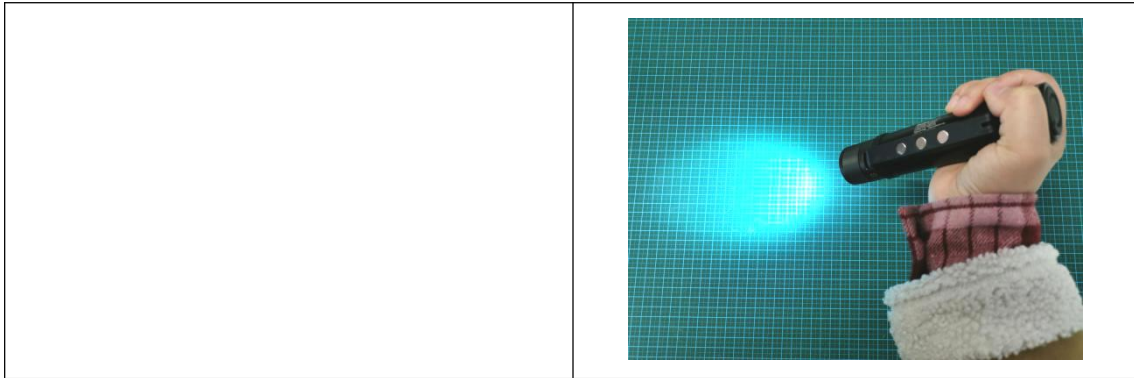

Activity Conclusion

The referable results are as follows.

	Light (Concentrated/Scattered)	Temperature (High/Low)
Direct	Concentrated	High
Oblique	Scattered	Low

As we can see from the above experiment, the direct light is concentrated, while the oblique light is scattered. The greater the angle of oblique light is, the more scattered the light is. With what we've learned about thermal radiation, we know that the energy is higher when the light is concentrated, and the temperature is higher.

Conjecture

Think about it, is the sunlight direct or oblique? Will the distribution of the sun's direct and oblique light on the earth change? Come up with your conjecture!

Part 2 Experiment: The Distribution of The Sun's Direct and Oblique Light on the Earth

In many places on the earth, people will experience spring, summer, autumn, and winter every year. The seasons alternate and repeat. Do you know why the cycle of the four seasons is one year? Will the distribution of the sun's direct and oblique light on the earth change during the year? Let's learn it together!

Let' s learn about the revolution of the earth first. The earth revolves around the sun, which is the revolution of the earth, and the time for one revolution is one year. During the year, the earth will revolve to different positions. The following figure shows the relative position of the earth and the sun in March, June, September, and December. During the revolution, the earth is slightly tilted.

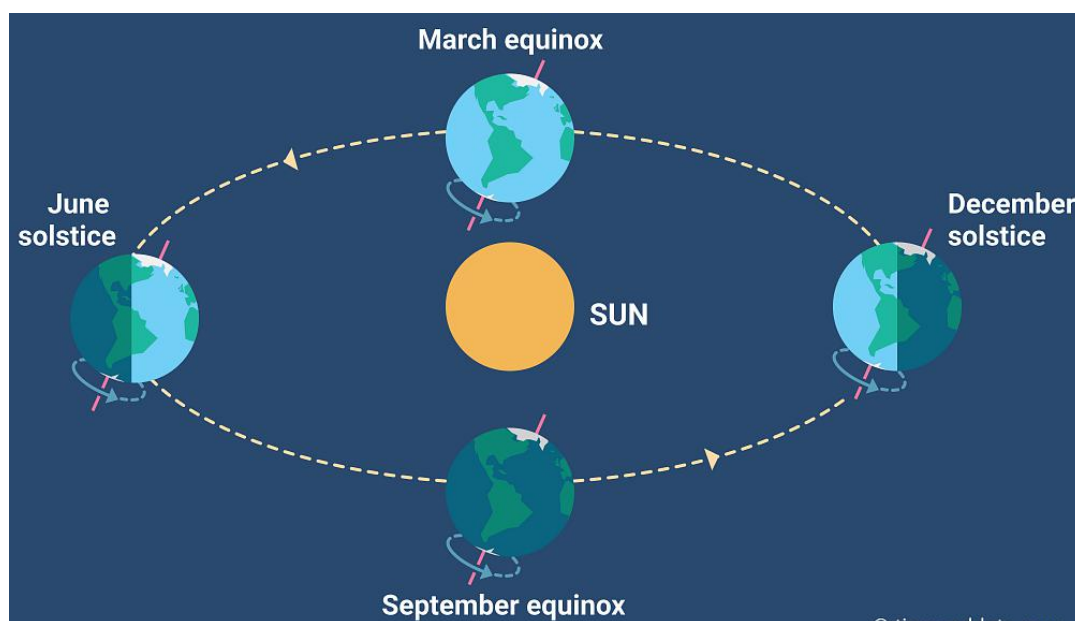

As the figure below, we can use a globe to represent the earth and a flashlight to represent the sun. Let the globe rotate around the flashlight to simulate the revolution of the earth. For example, in March, when the earth is in front of the sun, we turn on the flashlight and shine it on the globe, just like the sun shines on the earth.

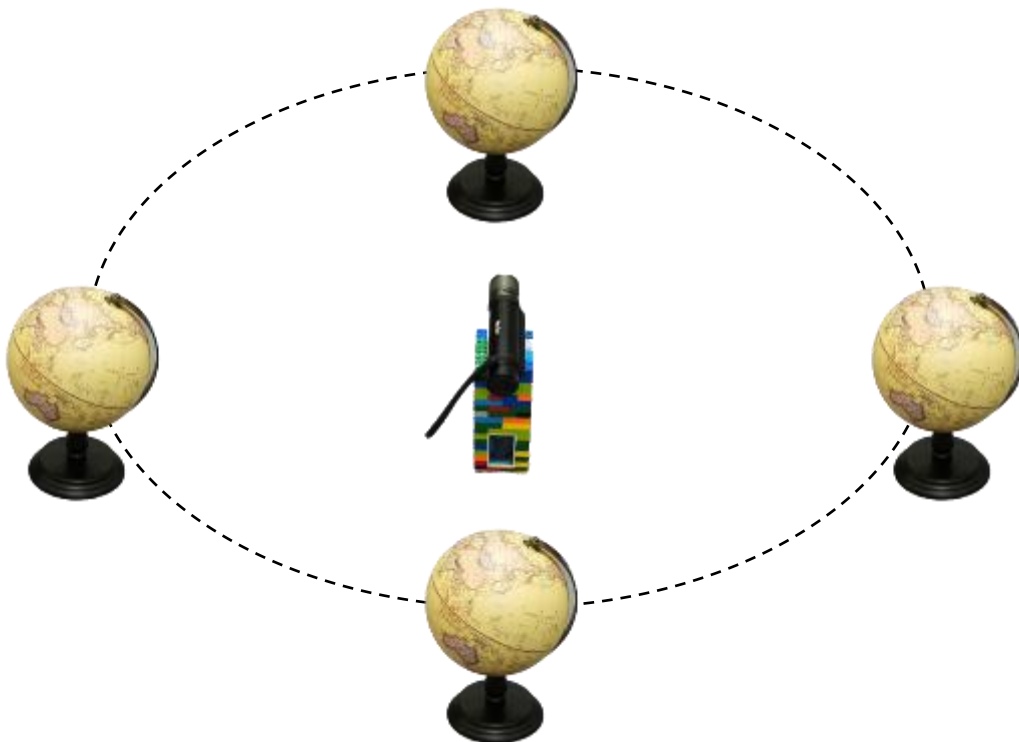

Now, let' s find a place with four seasons and observe the changes of light here as the earth revolves. For example, we select Guangzhou, China as the location. Find the location of Guangzhou on the globe (it is located near the Tropic of Cancer in China), and use the BOSON light sensor to detect the light intensity.





Finally, we choose March, June, September, and December as the observation points, when the earth revolves to the front, left, back, and right positions of the sun, observe whether the light in Guangzhou is direct or oblique, and whether the oblique angle is large or small. Record the results in the table below.

	March	June	September	December
Light intensity				
Direct/Oblique				
Angle of Oblique				

Materials

Prepare the following BOSON modules and other materials.



 <p>Display Module(o11)</p>	 <p>MainBoard-1IO (m2)</p>	 <p>Temperature Sensor (i11)</p>
 <p>Battery Holder (3x AAA batteries installed)</p>		 <p>BOSON cable *2</p>
 <p>Flashlight</p>	 <p>Globe</p>	 <p>LEGO Block</p>

Step

1. First, build an experimental circuit, and detect the light intensity through the light sensor.

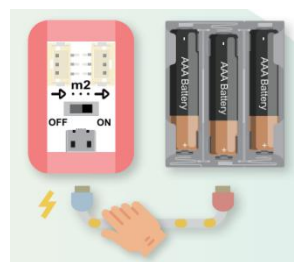
1-1 Connect the Battery Holder and two Module Cables to the Main Board.

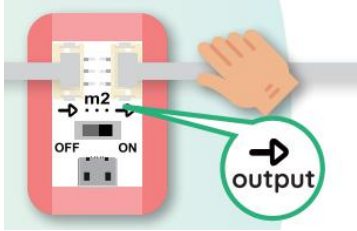
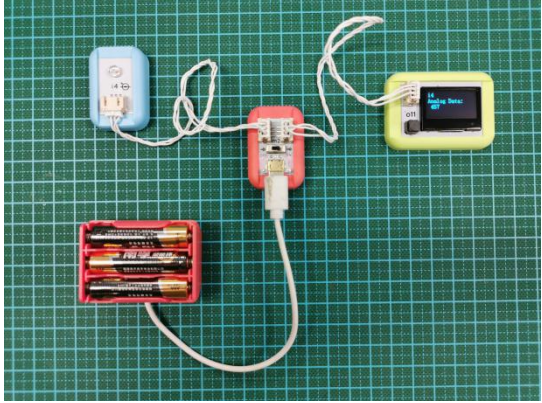
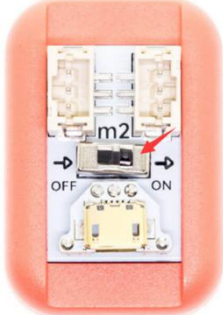

	 <p>The cable's pin header should be plugged in completely so that it is not easy to pull it out.</p>
<p>1-2 Connect the Display Module to the output side of the Main Board with a Module Cable.</p>	
<p>1-3 Connect the Light Sensor to the input side of the Main Board with a Module Cable.</p>	
<p>1-4 Dial the power module to "ON" .</p>	
<p>1-5 Press the black button at the lower left corner of the display module several times until " i4 Analog Data" is displayed on the screen.</p>	

2. After finishing the circuit connection, use the "Globe-Flashlight" to build the "Earth-Sun" revolution model.

2-1 Build a base with LEGO blocks and put the flashlight on it. Make the height of the flashlight the same as the center of the globe and fix the flashlight with blue tack.



2-2 Fix the light sensor at the position of Guangzhou with blue tack.



2-3 In March, place the globe in front of the flashlight, and make the flashlight face the globe with a distance of 30cm.
Note: the globe is tilted in the same direction as the image on the right.

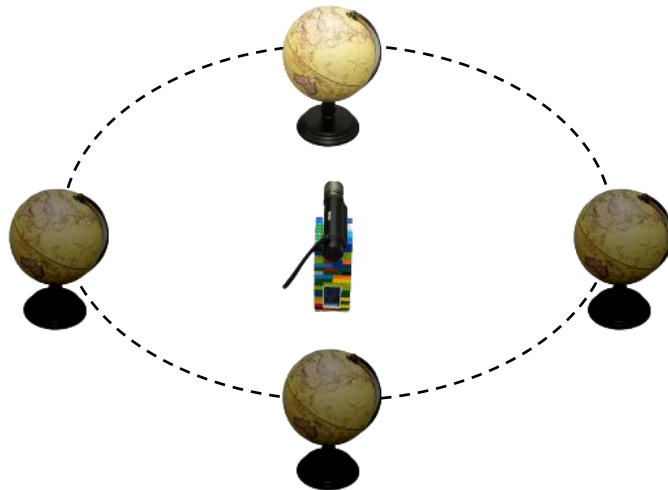

2-4 Make Guangzhou face the flashlight. Turn on the flashlight, check the light intensity on the screen, and record the results in the column of March.

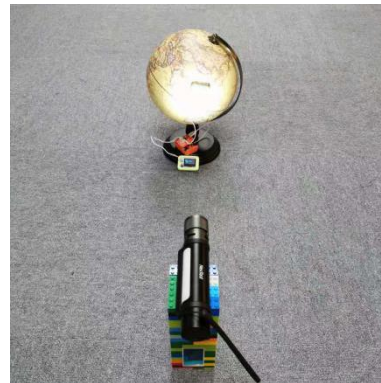

2-5 In June, place the globe on the left side of the flashlight, and make the flashlight face the globe with a distance of 30cm.

Note: the globe is tilted in the same direction as the image on the right.

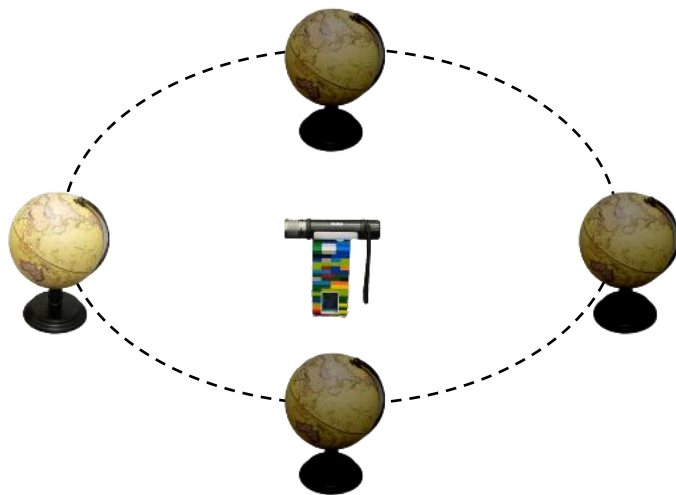

2-6 Make Guangzhou face the flashlight, and it will be blocked by the globe stand. So, we can fix the light sensor on the stand of the globe.



Turn on the flashlight, check the light intensity on the screen, and record the results in the column of June.



2-7 In September, place the globe behind the flashlight, and make the flashlight face the globe with a distance of 30cm. Note: the globe is tilted in the same direction as the image on the right.

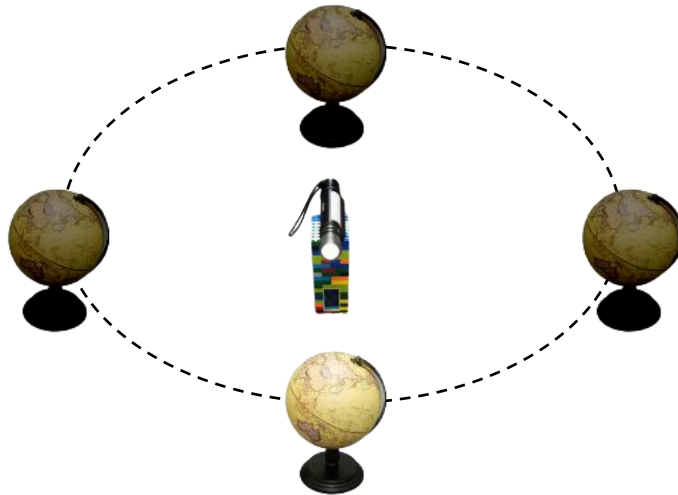

2-8 Make Guangzhou face the flashlight. Turn on the flashlight, check the light intensity on the screen, and record the results in the column of September.

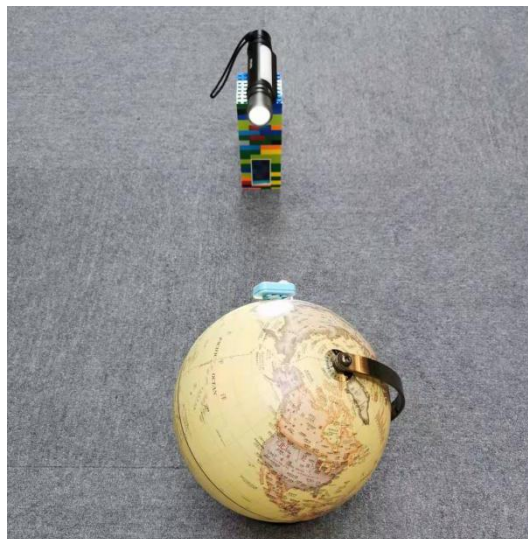

2-9 In December, place the globe behind the flashlight, and make the flashlight face the globe with a distance of 30cm.

Note: the globe is tilted in the same direction as the image on the right.

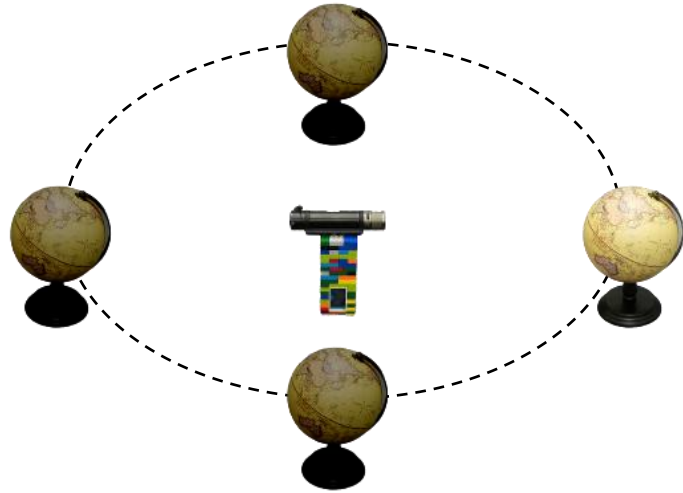

2-10 Make Guangzhou face the flashlight. Turn on the flashlight, check the light intensity on the screen, and record the results in the column of December.



Activity Conclusion

The referable experimental data are as follows:

	March	June	September	December
Light intensity	827	1112	812	311
Direct/Oblique	Oblique	Direct	Oblique	Oblique
Angle of Oblique	Small	/	Small	Large

The referable line chart is as follows:

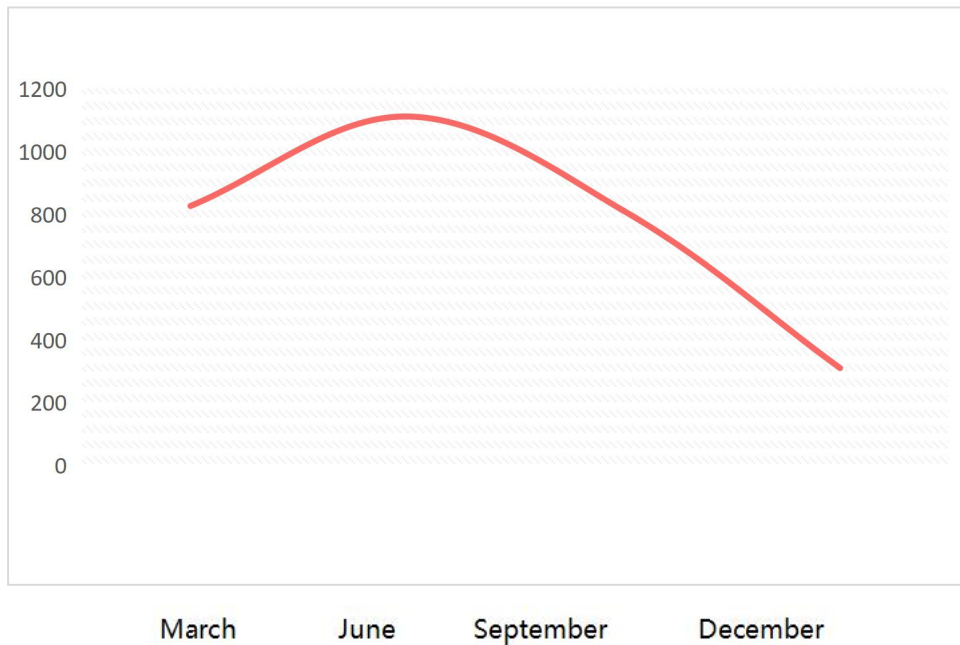

From the data, we can see that in Guangzhou, it is direct light in June, when the light is the strongest; In March and September, it is oblique light with a small oblique angle, and moderate light intensity; In December, it is also oblique light, with a larger oblique angle. The light is the weakest during this period. According to the information, Guangzhou will enter the hot summer in June, spring and autumn in March and September, and cold winter in December.

It can be concluded that the change in the angle of light irradiation corresponds exactly to the seasonal temperature change. When it is direct sunlight, the light is strong and the temperature is high; when it is oblique sunlight, the light is weak and the temperature is low. As the earth revolves, the angle of illumination in Guangzhou changes, causing

temperature change, forming the four seasons of spring, summer, autumn and winter.

Now you know why spring is followed by summer, not winter!

Science Background

In the experiment, we assume that the sunlight is a parallel beam like the flashlight. Is the sunlight really a parallel one? Let's have a look!

Is Sunlight a Parallel One?

The sun is like a shining fireball, radiating light equably around. The sunlight is not parallel theoretically. But because the distance between the earth and the sun is very far, about 150 million kilometers, the sunlight on the earth can be approximately regarded as parallel light.

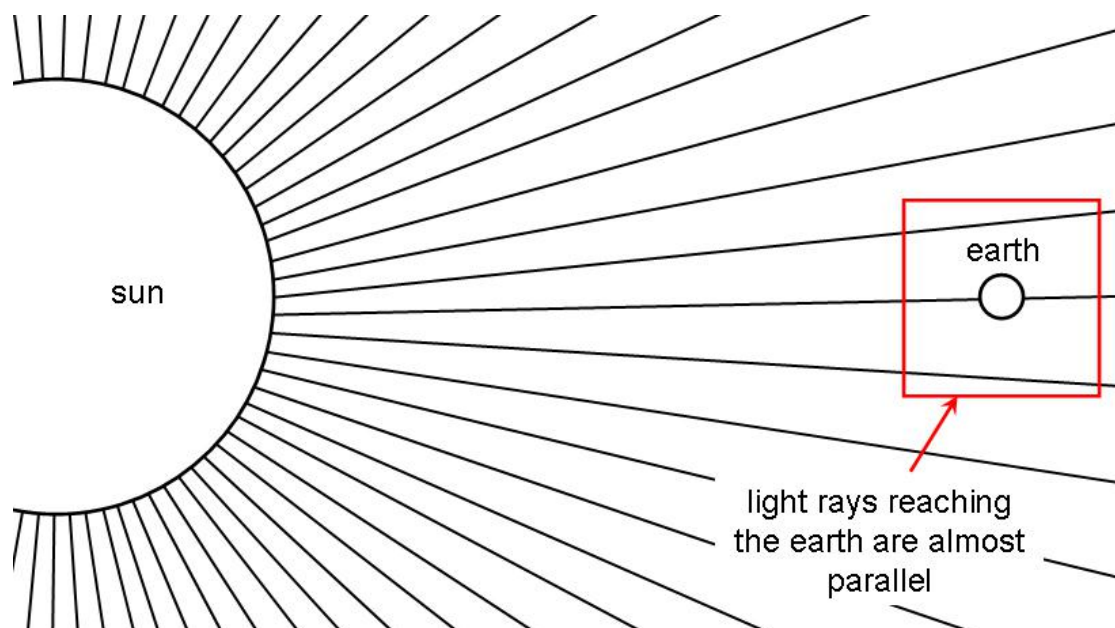

The Direct and Oblique Light on the Earth

If you regard sunlight as parallel light, since the earth is a sphere, there are some places where sunlight is direct light, while there are some places where sunlight is oblique light, it depends on the angle between the light and the surface of the earth. For example, in the picture below, in the equatorial region, the light is perpendicular to the surface of the earth, so it is direct light, and when going to the south or north pole from the equator, the light gradually obliquates, so it is oblique light.

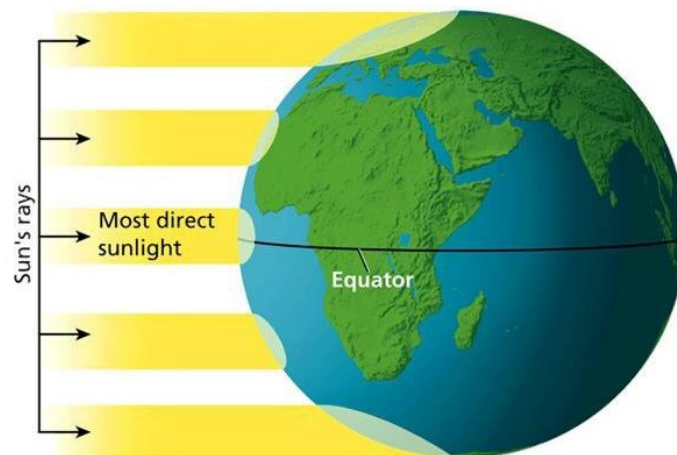

The Rotation and Revolution of the Earth

As everyone knows that the earth is not stationary. There are two forms of motion, one is revolving around the sun, the other is rotation around its axis of rotation.

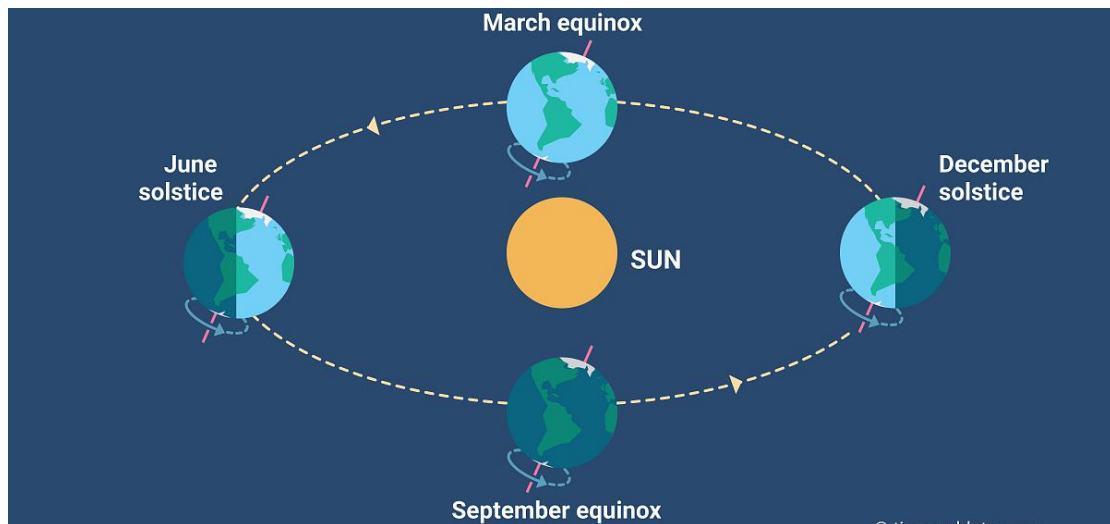

Most celestial bodies in the universe rotate, and the earth rotates for about 24 hours a turn, which is one day. The plane formed on the equator when the earth rotates is called the equatorial plane.

Because of the gravity of the sun on the earth, the earth will also revolve around the sun. One revolution of the earth takes about 365 days, that is, a year. The plane on which the earth revolves around the sun is called the ecliptic. There is a fixed angle between the equatorial plane and the ecliptic plane, called the obliquity of the ecliptic, which is about 23.4° .

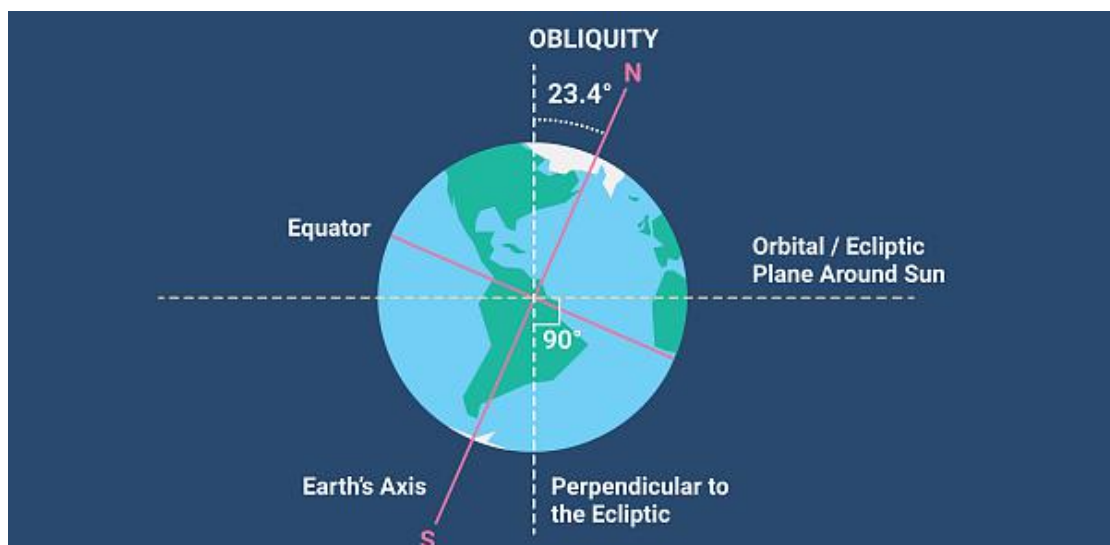

The Formation of Four Seasons

Since the earth always revolves around the sun in a tilting condition, the direct light from the sun is centered on the equator and constantly sweeps north and south with the Tropic of Cancer as the boundary once a year, thus forming the four seasons, and the sequence of alternation.

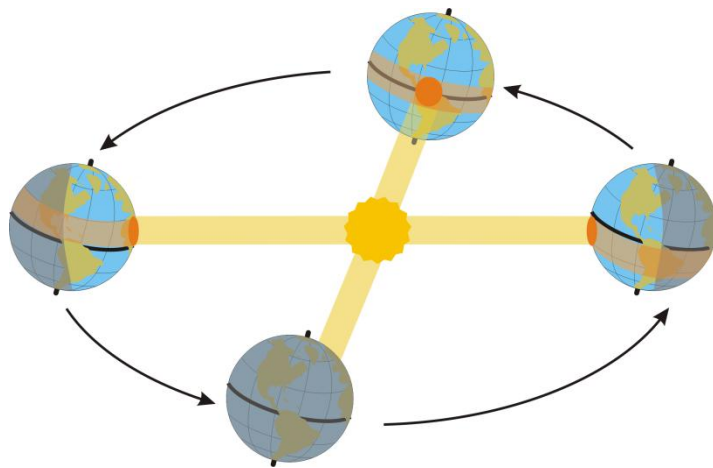

Conclusion

In this project, we first observed the direct and oblique light phenomenon, and then constructed a simple "earth-sun" model, simulated the process of the earth's revolution in the experiment, and learned the formation of the seasonal alternation.

The project is going to an end, please remove cables, and put all the BOSON modules back into the kit according to the corresponding position.

Extend

1. Why are the seasons opposite in the northern and southern hemispheres? Is there seasonal alternation near the equator?
2. The orbit of the earth' s revolution is actually an ellipse, and there are perihelion and aphelion on it. Will they influence the seasonal alternation?

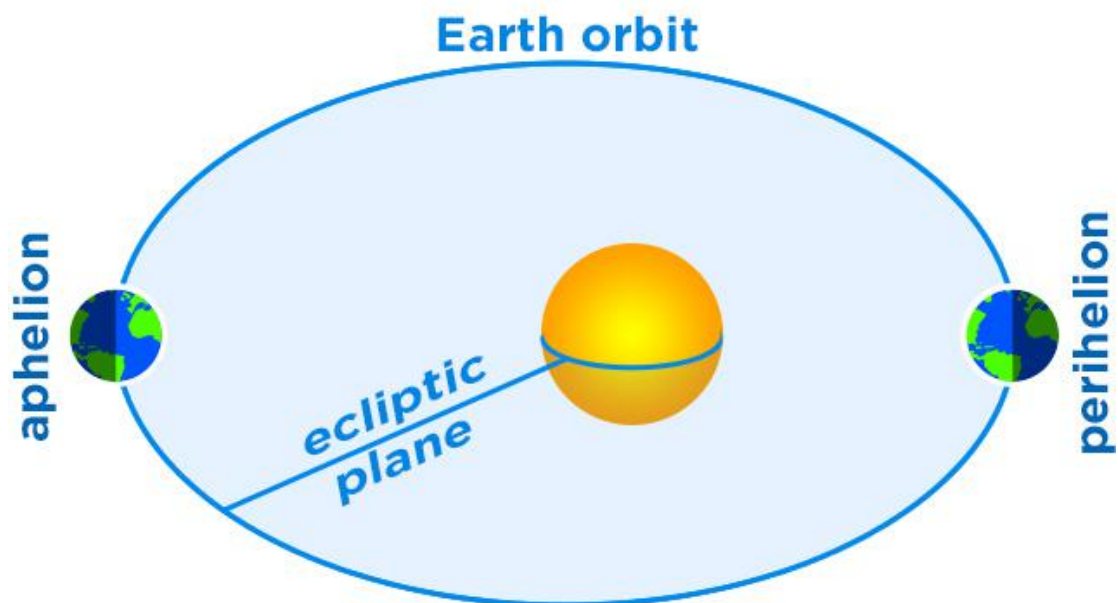

Appendix – Explore “Why are the seasons opposite in the northern and southern hemispheres?”

There are three crucial lines on the globe, namely the Tropic of Cancer, the Equator, and the Tropic of Capricorn. North of the equator is the northern hemisphere, and south of the equator is the southern

hemisphere. During one year, the seasons are opposite in the northern and southern hemispheres. Why is this? Let's explore it together!

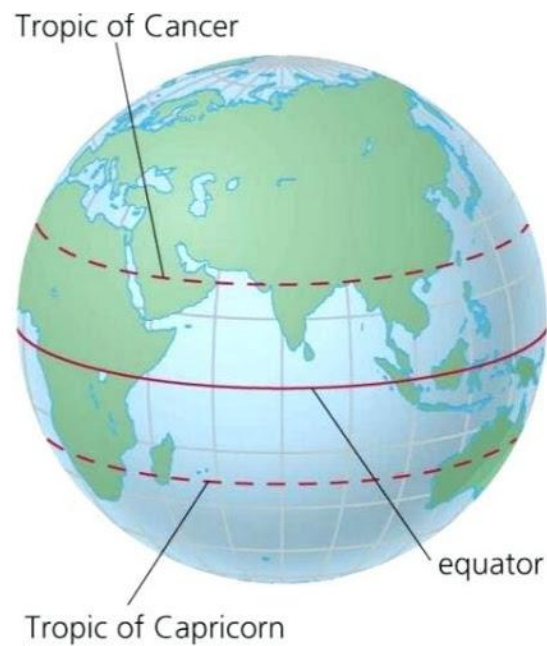

Use the "Globe-Flashlight" model to simulate the earth's revolution. During the revolution, we use the BOSON light sensor to detect the light intensity values at the Tropic of Cancer, Equator, and Tropic of Capricorn in March, June, September, and December. Check the distribution of light in different places on the earth at the same time.



Tropic of Cancer



Equator



Tropic of Capricorn

Step

1. Continue to use the previous experimental circuit and model.

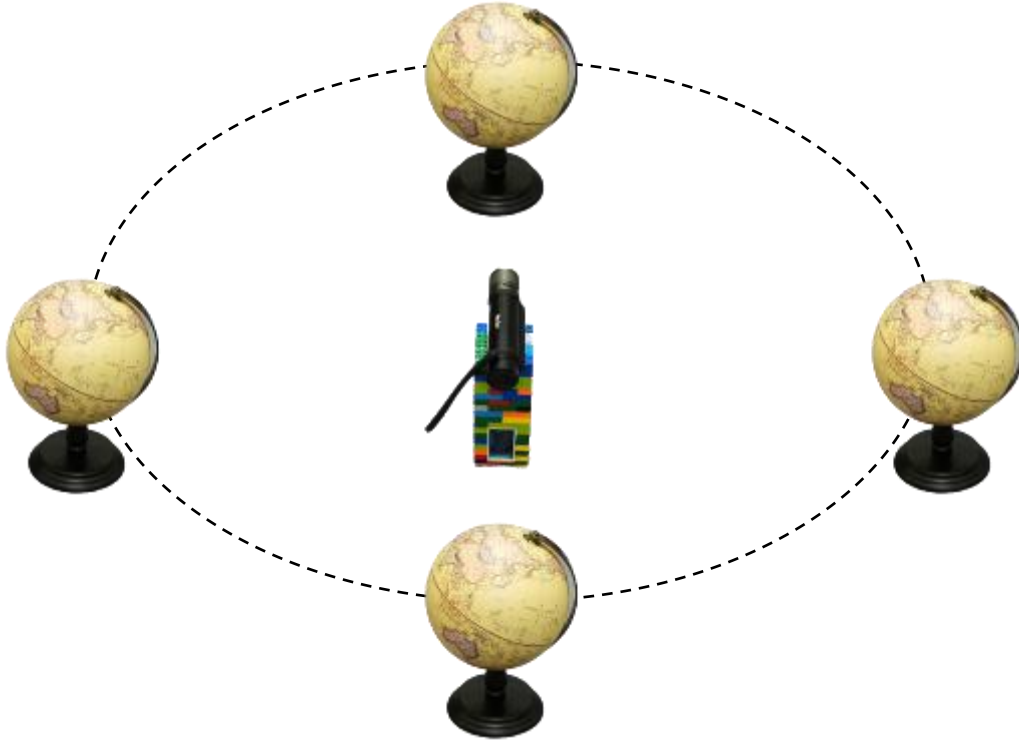

2. Record the light intensity at the Tropic of Cancer, Equator, and Tropic of Capricorn in March, June, September, and December. Fill them in the table.

	March	June	September	December
Tropic of Cancer				
Equator				
Tropic of Capricorn				

Activity Conclusion

The referable experimental data are as follows:

	March	June	September	December
Tropic of Cancer	826	1003	817	311
Equator	1010	923	1002	908
Tropic of Capricorn	811	203	831	1005

The referable line chart is as follows:

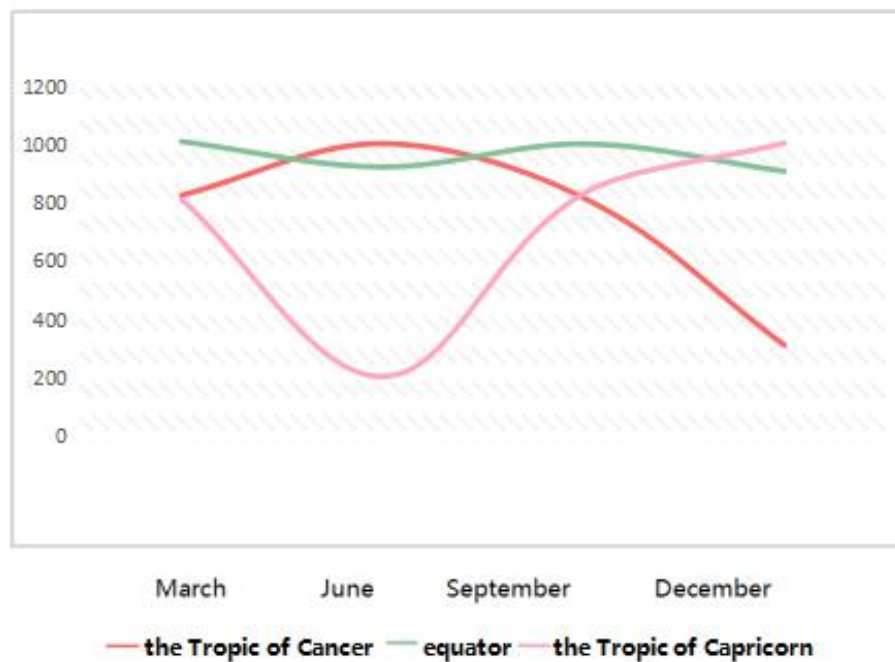

Through experiments, we can know that in March the sun shines directly on the equator. By this time, it is spring in the northern hemisphere and autumn in the southern hemisphere; then the point of direct light gradually moves northward, and the sun shot directly on the Tropic of Cancer in June, and it is summer in the northern hemisphere and winter in the southern hemisphere. ; Then the direct shot point gradually moved south, and in September the sun shot directly on the equator, and by this time, it is autumn in the northern hemisphere and spring in the southern

hemisphere; Then the point of direct light continued to move southward and the sun shot on the Tropic of Capricorn in December, and by this time, it is winter in the northern hemisphere and summer in the southern hemisphere.

When the earth revolves, the direct light always sweeps back and forth between the Tropic of Cancer and the Tropic of Capricorn, so the seasons are opposite in the northern and southern hemispheres. In the equatorial region, the light intensity in a year does not change much, so there will be no obvious seasonal alternations.

LESSON 6: Why Do Very Few Plants Grow in Deserts?



Introduction

Standards

NGSS

5-LS1-1 To expound and prove that plants mainly get nutrients from air and water.





Science - Grade 3-5





Overview





This lesson focuses on talking about the question “why do very few plants grow in deserts” , and leading students to find out the difference between sand and soil. It aims to help students explore the difference in water storage capacity between sand and soil through experiments, and understand that water in the soil is stored in soil pores through capillarity.

Materials

BOSON Module	Image	Function
--------------	-------	----------

<p>Battery Holder (3x AAA batteries installed)</p>		<p>4.5V Power Supply</p>
<p>MainBoard-1IO (m2)</p>		<p>Provide power for other modules</p>
<p>Soil Moisture (i16)</p>		<p>Measure the moisture of the soil</p>
<p>Display Module(o11)</p>		<p>Provide visible effect for users to check experiment results</p>
<p>BOSON cable *2</p>		<p>Use with 3-Pin fool-proof connector to connect other modules</p>

Additional Materials	Image	Function
Sand		<p>It is used for experimental exploration. It can be obtained from the beach or toy sand.</p>
Soil		<p>It is used for experimental exploration. It can be obtained from the potting or garden.</p>
Paper x2		<p>It is used to hold sand and soil.</p>
Disposable Cup x2		<p>It is used to hold sand and soil.</p>

Beaker x4		It is used to measure the amount of sand, soil, and water.
Water		For experimental exploration.
Screwdriver		It is used to dig holes in the disposable cup
Magnifying Glass		It is used to observe the sand and soil.

Engage

Our general impression of deserts is that they are vast seas of sand, piled up into dunes, always very barren, with scarce plants. But in most plain areas on land, there are large areas of grassland, arable land, and forests, which breed a variety of plants. Have you ever wondered why there are so few plants in the desert?

We know that plants cannot grow without water, while deserts are often dry all year round. So, could it be that there are so few plants in the

desert because of the lack of water? Let's make a bold assumption that if there is enough precipitation in the desert, can sand breed life? Can sand hold water like soil? Have a guess!



Explore

The experiment is divided into two parts. The first part is to observe sand particles and soil particles. In the second part, we will compare the difference in water storage capacity between sand and soil.

Part 1 Observation: What's the Difference between Sand and Soil

We use a magnifying glass to observe sand particles and soil particles, compare the particle size and uniformity, and record the results in the table below.

	Sand	Soil
Particle Size		
Particle Uniformity		

Materials

	
Sand	Soil
	
Paper x2	Magnifying Glass

Step

1-1 Prepare two sheets of paper, place some dry sand on one paper, and put some soil on the other.



1-2 Observe the sand and soil particles with a magnifying glass, and record the results in the table.



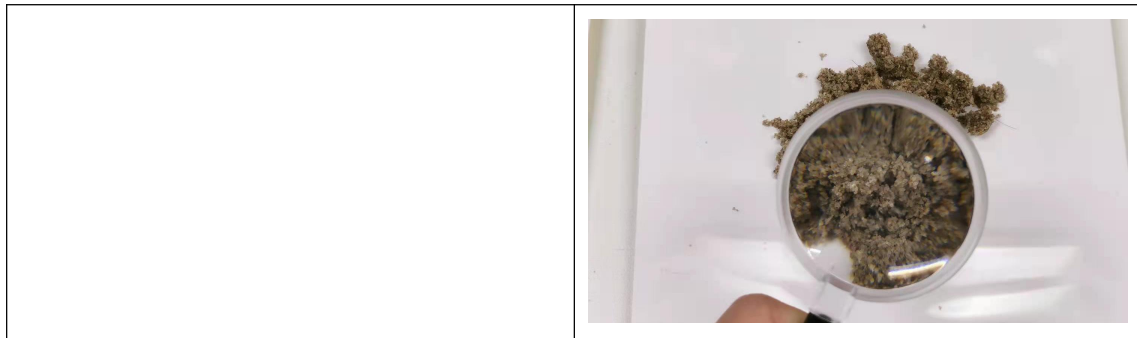

Activity Conclusion

The referable results are as follows:

	Sand	Soil
Particle Size	Large	Large, Small
Particle Uniformity	Uniform	Nonuniform

Through the above observation, it can be found that the sand particles are large and uniform in size, while the soil particles are with both large and small size, and nonuniform in size.

Conjecture

If the same amount of water is given to sand and soil, which one is more likely to hold water? Take a guess!

Part 2 Experimental Exploration: Which Holds Water better, Sand or Soil?

In order to investigate the water storage capacity of sand and soil, we can add equal amounts of water to sand and soil. Then use BOSON soil moisture sensor to observe changes in moisture of sand and soil. And we

use the data to verify whose water storage capacity is better. The referable experimental table is as below.

	Initial Value	0min	10min	20min	30min
Sand					
Soil					

Materials

Prepare the following BOSON modules and other materials.

 <p>Display Module(o11)</p>	 <p>MainBoard-11O (m2)</p>	 <p>Soil Moisture (i16)</p>
 <p>Battery Holder (3x AAA batteries installed)</p>		 <p>BOSON cable *2</p>
		

Disposable Cup x2	Beaker x4	Water
 <p>Screwdriver</p>		

Activity Step

1. Let's build an experimental circuit together to detect the soil moisture value.

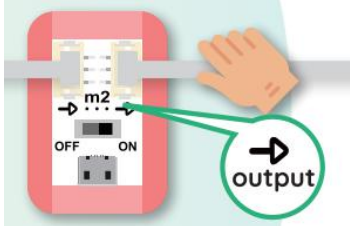
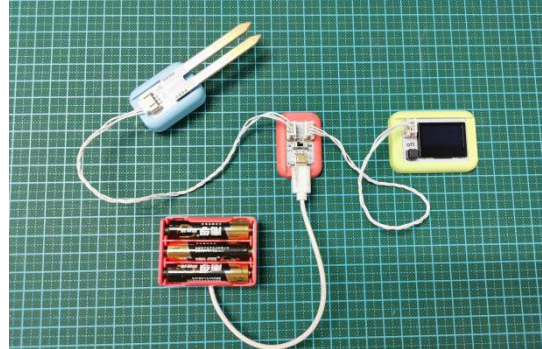
<p>1-1 Connect the Battery Holder and two Module Cables to the Main Board.</p>	
<p>1-2 Connect the Display Module to the output side of the Main Board with a Module Cable.</p>	
<p>1-3 Connect the Soil Moisture to the input side of the Main Board with a Module Cable.</p>	

1-4 Switch the Main-board to "ON" .

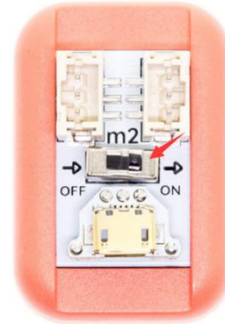

1-5 Press the black button at the lower-left corner of the display module several times until " i16 Analog Data" is displayed.



1-6 Hold the probes of the soil moisture sensor with your hands, it will display the moisture of your hand. When releasing, the value will be 0.

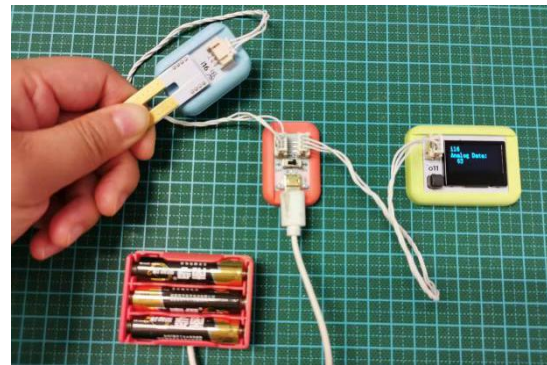

2. After completing the circuit connection, set up the two experimental groups of sand and soil. The experimental process is as follows.

2-1 Take two paper cups and use a screwdriver to dig the same number of holes at the bottom of each cup. Try to make the positions of the two paper cups the same.
Note: You can also spread a layer of gauze on the bottom to prevent



sand or soil from losing through the holes.
the holes.

2-2 Take two beakers, measure the same amount of soil and sand, and pour them into two paper cups.



2-3 Insert the BOSON soil moisture sensor into the soil, measure the initial soil moisture value, and record it in the table. Clean the soil moisture sensor, then insert it into the sand, try to keep it at the same depth, measure the initial moisture value of the sand and record it in the table.

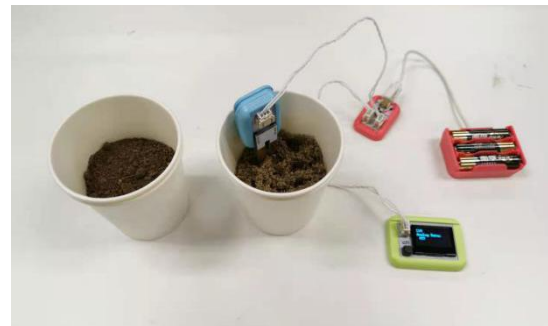

2-4 Put the cups with sand and soil onto two beakers to prevent water from leaking out when watering.



2-5 Take two new beakers and add the same amount of water to each. Pour two cups of water into the sand and soil separately.



2-6 After adding water, use BOSON soil moisture sensor to measure the moisture value of sand and soil again and record data in the table



Note 1: After measuring the humidity of one cup, clean the sensor probes and dry up before measuring the next one.



Note 2: Only the probes of the soil moisture sensor(yellow parts) are waterproof. Do not let other parts contact with water, otherwise, the sensor may be damaged.	
2-7 Next, measure the moisture value every 10 minutes and record data in the table.	

Activity Conclusion

The referable data is as follows:

	0min	10min	20min	30min	40min	12h
Sand	0	552	510	460	420	306
Soil	114	675	662	638	626	620

Observing the above table, we may find that the obtained data are not convenient for us to directly see the changes in soil moisture and sand moisture as time goes by. What should we do?

The data directly measured in the experiment is generally called the original data. In order to obtain the information we want, it is often necessary to process the original information. For example, in this experiment, we want to see the change in soil moisture as time goes by,

so we can subtract the original data at two moments to get the change over a period of time. As the table below.

	0-10min	10-20min	20-30min	30-40min	40min-12h
Sand	552-0	510-552	460-510	420-460	306-420
Soil	675-114	662-675	638-662	626-638	620-626

The results obtained are as follows, "+" means increase, "-" means decrease.

	0-10min	10-20min	20-30min	30-40min	40min-12h
Sand	+552	-42	-50	-40	-114
Soil	+561	-13	-24	-12	-6

From the above table, it can be concluded that within 10 minutes after adding the same amount of water, the sand moisture increases by 552 and the soil moisture increases by 561, which are relatively close. Every 10 minutes thereafter, the moisture value of the sand decreases more than that of the soil. Especially after 12 hours, the moisture of the sand decreases by 114, while the soil one decreases by only 6. It shows that the water loss in the sand is faster than that in the soil.

Therefore, we can draw the conclusion: the water storage capacity of sand is weak, and that of soil is strong.

Sand cannot hold water, and consequently it cannot provide water for plants. Even if it rains heavily in the desert, the rainwater will quickly run away from the sand, and it is still difficult for plants to survive.

Science Background

In the experiment, we first observed the particle size of sand and soil, and then explored the water storage capacity of sand and soil. Why can the soil hold more water? Does this have anything to do with their particle size? How do we distinguish sand and soil? Let's learn together!

How Does the Soil Hold Water?

In Part 1, we can see through a magnifying glass that the soil particles are nonuniform in size. Because of this, these soil particles are stacked together, leaving pores of different sizes between the soil particles. Most of the water in the soil is stored in these pores. This phenomenon is called capillarity. The capillarity allows water to overcome gravity and adhere to small pores.

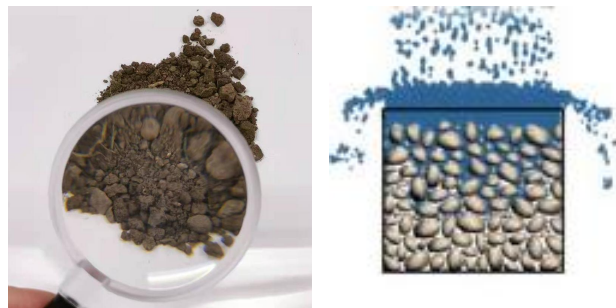

If it rains heavily, the pores of the soil are already full of water, and the excess water will be drained from the ground surface, forming a stream, and flowing to low-lying lakes, ponds, and ditches. If there is a continuous drought and there is no water in the pores of the soil, the soil will become dry, cracked and caked.



Why Cannot Sand Hold Water?

In Part 1, we can see through a magnifying glass that the sand particles are large and uniform. Because of this, the pores between the sand particles are also relatively large, and the capillarity generated is weak. Water will pass through the sand under gravity. This is why the sand cannot hold water.

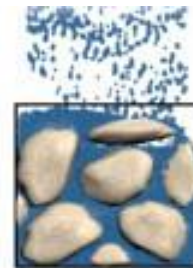

Learn Soil and Sand

Soil is a complex mixture of minerals, water, air, organic matter and countless creatures. The soil particles are of all sizes. Some scientists divide soil particles into three types: clay, silt and sand according to their diameter. So sand is actually a kind of soil!

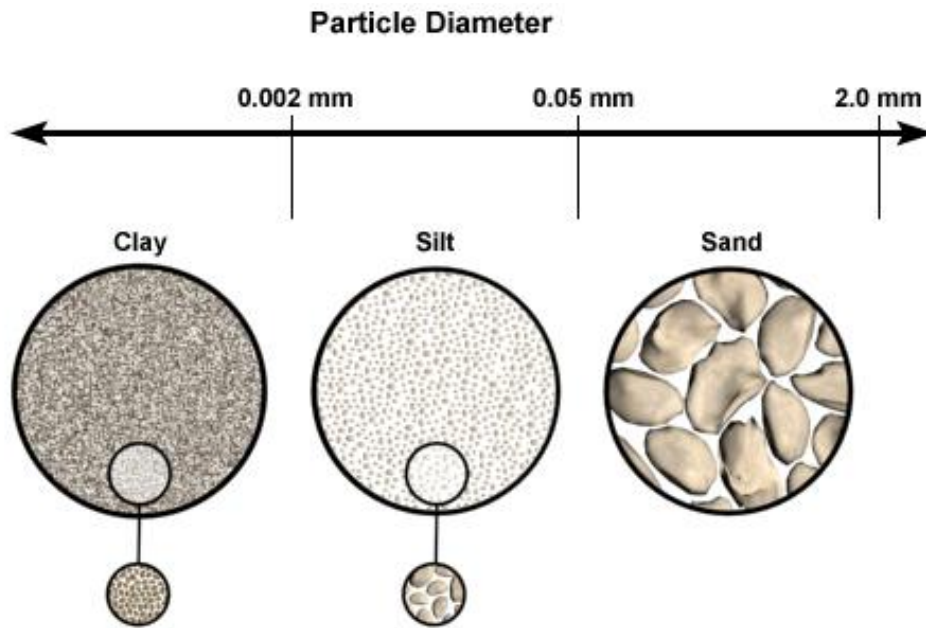

According to the proportion of clay, silt and sand in the soil, the soil can be divided into clay, loam and sandy soil.



Clay has small pores and strong capillarity, so it has a strong water storage capacity. Sandy soil has large pores and a weak capillarity, so the water storage capacity is weak. The water storage capacity of loam is between clay and sand, weaker than clay and stronger than sand.

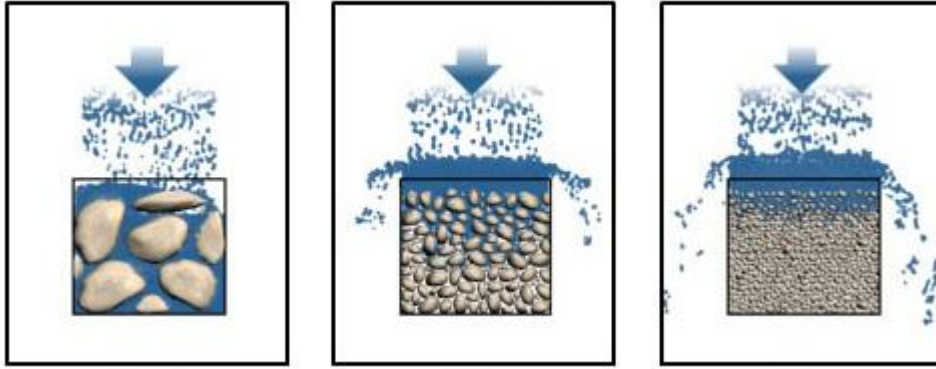

Conclusion

In this program, starting from “why there are few plants in the desert” , we learned the difference in water storage capacity between sand and soil through observation and experimental exploration.

The project is going to an end, please remove cables, and put all the BOSON modules back into the kit.

Extend

1. What are the characteristics of the roots of desert plants? And why is it?

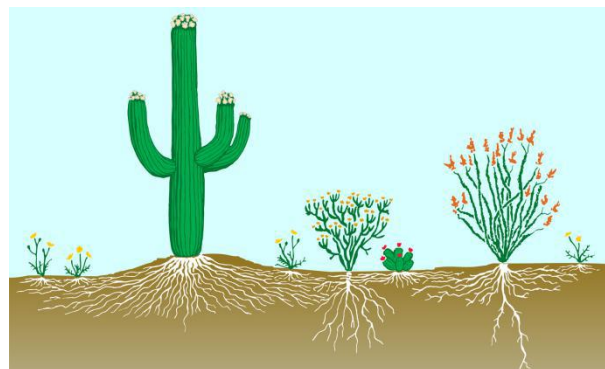

2. What is the climate like in the desert? Will this affect the water storage of sand?

3. Why does the land become a desert? How can we prevent desertification?



LESSON 7: How Does the Water Cycle Work?



Introduction

Standards

NGSS

5-PS1-1 Develop a model to describe that substance is composed of small and invisible particles

5-PS2-1 Demonstrate that the gravity effect of the earth on objects is downward

5-ESS2-1 Develop a model to describe how the lithosphere, biosphere, hydrosphere, and atmosphere interact with each other.

MS-ESS2-4 Develop a model to describe the circulation of water in the earth system driven by solar and gravitational potential energy.

Science - Grade 3-5



Overview



This lesson will lead students to think about the question "where does the rainwater come from and where does it go?", observe the movement of water droplets on the glass of ice water. By using soil, water and plastic box to build a simple water cycle model, they will explore the formation process of the water cycle, learn the three forms of water and





the distribution of water on the earth, and understand the dynamic process of the water cycle and what role water cycle plays in the lithosphere, biosphere, hydrosphere and atmosphere.

Materials

BOSON Module	Image	Function
Battery Holder (3x AAA batteries installed)		4.5V Power Supply
MainBoard-1IO (m2)		Provide power for other modules
Soil Moisture (i16)		Measure the moisture of the soil

Display Module(o11)		Provide visible effect for users to check experiment results
BOSON cable *2		Cooperate with 3-Pin fool-proofing connector to connect other modules

Additional Materials	Image	Function
Water		It is used for experimental exploration.
Ice Cube		It is used for experimental exploration.

<p>Storage Box</p>		<p>It is used to build the model of water cycle</p>
<p>Plastic Wrap</p>		<p>It is used to build the model of water cycle</p>
<p>Soil</p>		<p>It is used to build the model of water cycle</p>
<p>Ziplock Bag</p>		<p>It is used to hold the ice cubes, being an ice bag</p>
<p>Warm-Light Lamp</p>		<p>Generate light and heat like the sun (be careful not to use cold-light lamps, they only generate light without heat)</p>

Engage

When it rains, we can see the rainwater dropping like beads. Have you ever wondered where does the rain come from? When the rain fell on the ground, the ground became wet; after the rain stopped, the ground slowly dried out. Where did the rain go?

In nature, there are many kinds of water, such as rainwater, seawater, etc. So, will the rain become less and less? Will the sea water amount increase continuously? Have your guess!



Explore

This experiment will be divided into two parts. In the first part, we are going to add some ice cubes into a glass of water, and observe the movement of water on the outer cup wall. In the second part, we are going to build a simple water cycle model, using soil and water to create land and ocean in the experiment box, and then explore the process of water cycle between land and sea.

Part 1 Observation: Is the Water Moving?

Add the ice cubes into the water, observe the changes on the outer cup wall, and record it in the table below.

	Before	After
The Outer Wall (Wet/Dry)		

Materials

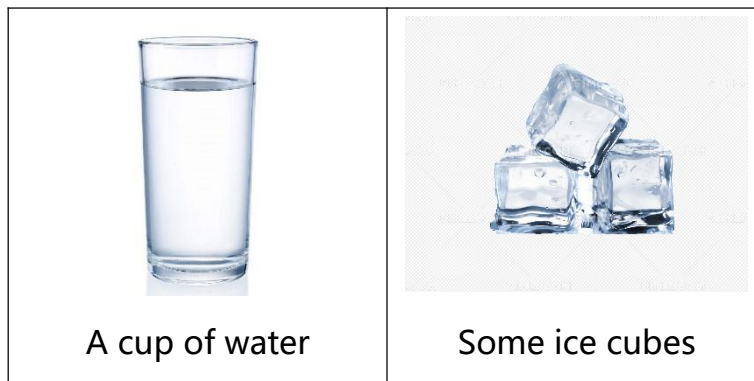

Step

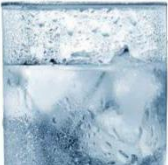
1-1 Prepare a cup of water at room temperature and dry the outer cup wall.	
1-2 Put the ice cubes into the water	

<p>1-3 Wait 5 minutes, touch the outer cup wall, observe whether it becomes wet, and record the result in the table.</p> <p>Note: it is recommended to perform this experiment in summer, the higher the room temperature is, the better the effect will be. If it is winter, it is best to turn on the indoor air conditioner and let the room temperature reach above 15°C, otherwise, you may not see obvious water droplets gathering on the cup wall</p>	
---	--

Activity Conclusion

The referable results are as follows:

	Before	After
The Outer Wall (Wet/Dry)	Dry	Wet

We see that the outer wall of the cup has become wet, and a lot of small droplets have gathered. Think about it, where does the droplets come from?

First of all, the small droplets must not flow out of the cup, or the cup is leaking. Considering that the outer cup wall is only in contact with the air, we speculate that there may be water in the air! It's just that the water in the air is so small that we can't see it. When it comes to a cold cup, the water in the air gathers together and becomes small drops on the outer cup wall!

In the same way, it can be speculated that the rain on the ground will dry out, perhaps it is because that the water on the ground returns to the air. The water in the air can gather on the cup wall, and the water on the ground can also return to the air. This indicates that the water is moving!

Conjecture

In nature, will water in rivers, lakes and seas move into the air? How did the water in the air turn into rain and return to the ground? How does the natural water cycle change? Let's continue to explore through experiments.

Part 2 Experimental Exploration: How Is Water Cycle Formed?

We are going to make a land-water model to explore the water cycle in nature.

In a plastic box, half of the space is the land created by soil and half is the ocean created by water. Seal the plastic box with plastic wrap to prevent water in the outside air from interfering with the experiment. Observe the formation process of the water cycle, and use BOSON soil moisture sensor to detect changes in soil moisture in the model



Materials

Prepare the following BOSON modules and other materials.

 <p>Display Module(o11)</p>	 <p>MainBoard-1IO (m2)</p>	 <p>Soil Moisture (i16)</p>
 <p>Battery Holder (3x AAA batteries installed)</p>		 <p>BOSON cable *2</p>
 <p>A Cup of Water</p>	 <p>Some Ice Cubes</p>	 <p>Storage Box</p>
 <p>Plastic Wrap</p>	 <p>Soil</p>	 <p>Ziplock Bag</p>

Step

1. First, build an experimental circuit to detect the soil moisture value.

1-1 Connect the Battery Holder and two Module Cables to the Main Board.

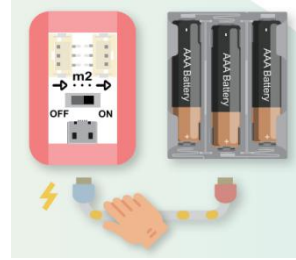

The cable's pin header should be plugged in completely so that it is not easy to pull it out.

1-2 Connect the Display Module to the output side of the Main Board with a Module Cable.

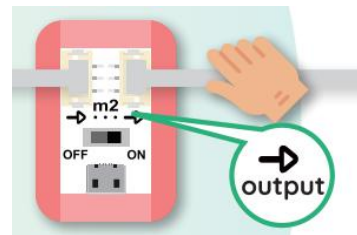

1-3 Connect the Soil Moisture to the input side of the Main Board with a Module Cable.

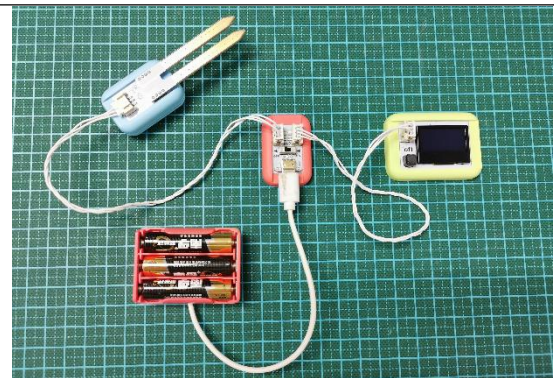

1-4 Dial the power module to "ON" . Press the black button at the lower-left corner of the display module several times until " i16 Analog Data" is displayed.



1-5 Hold the two probes of the soil moisture sensor with your hands, it will display the moisture of your hand. When releasing, the value will be 0.

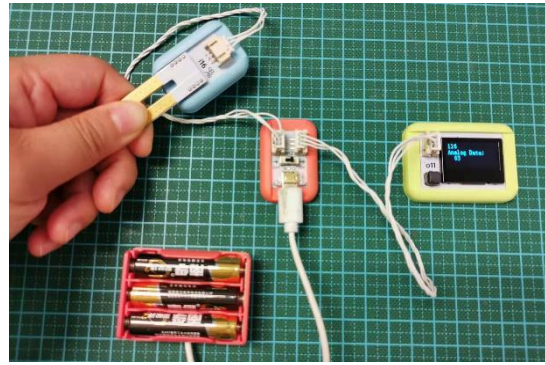

2. After completing the circuit connection, let' s build the water cycle model together.

2-1 Prepare a plastic box and pour the soil on one side of the box to simulate a land. Compact the soil.



2-2 Pour suitable water on the other side of the box to simulate an ocean.



2-3 Insert the soil moisture sensor into the soil.

Note: Except for the yellow probes of the sensor, other parts of the sensor cannot be exposed to water, otherwise the sensor may be burnt.



2-4 Seal the box with plastic wrap and stick the plastic wrap with tape



2-5 Put some ice cubes into the zip lock bag to make an ice bag



2-6 Place the ice bag on the plastic wrap on the top of the box, above the soil.



2-7 Select a warm and sunny day, place the model under the sun to heat it up. If the weather is bad, you can use a warm-light lamp to heat it.



2-8 Try not to touch the model during the experiment. Record the value of the soil moisture sensor every 10 minutes.



Soil Moisture Value Table:

Time	10min	20min	30min	40min	50min
Moisture Value					

Activity Conclusion

Soil Moisture referable data:

Time	10min	20min	30min	40min	50min
Moisture Value					

Through the experimental data, we can know that although the moisture of the soil does not change much, the value is still generally getting higher.

In the water cycle model we created, we can clearly see that under the heating of the sun, the plastic box is full of water vapor. This is because the water in the "lake" evaporates into the air. When the water in the air increases, encountering the cold ice cubes on the plastic wrap, it will

condense together and turn into small droplets, and then drop into the soil. Is this similar to the process of rain?

By the same token, in nature, the heat of the sun will cause the water on the sea surface to evaporate into the air, and it will condense in the sky and form clouds. With more and more small droplets in the clouds, rain will form and fall on the ground, flow into the river, and eventually part of the water return to the ocean. This is the water cycle!

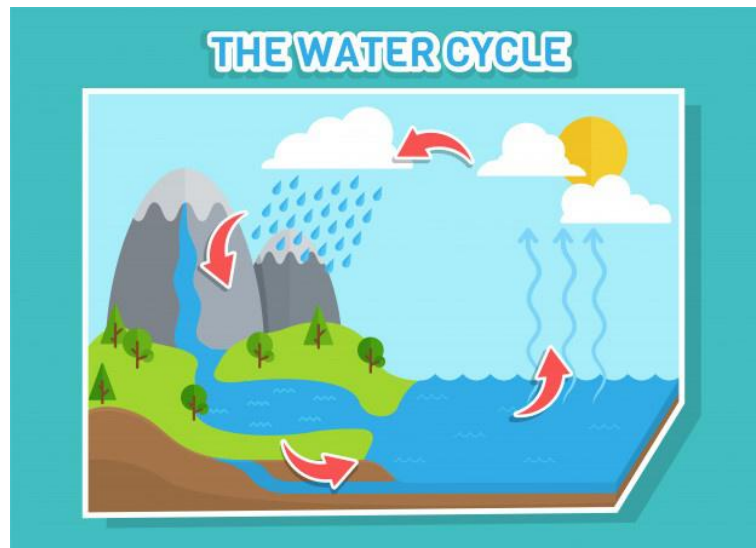

Science Background

Through experiments, we have a general understanding of the water cycle among the ocean, air and land. Let' s get to learn the water cycle between water and nature together!

Three Forms of Water

We all know that when water freezes, it turns into ice, and boiling water will evaporate into water vapor. In physics, ice is called solid water, water

We can see the white steam on the boiling kettle mouth, because the water vapor is cooled by the surrounding air and turned into small droplets.

Water Cycle in Nature

Due to the three types of changes of water form, the water in nature can circulate continuously.

The heat of solar radiation evaporates a large amount of water from the sea, lakes, rivers and land, turning into water vapor and moving into the air. When the water vapor in the air encounters cold temperature, it will turn into a cloud, and more and more water droplets in the cloud will fall to the ground as rain or snow. The rainwater that falls on the ground may evaporate again, or it may be transformed into groundwater, soil water and surface runoff, and eventually part of the water returns to the ocean, thus a natural cycle is formed.

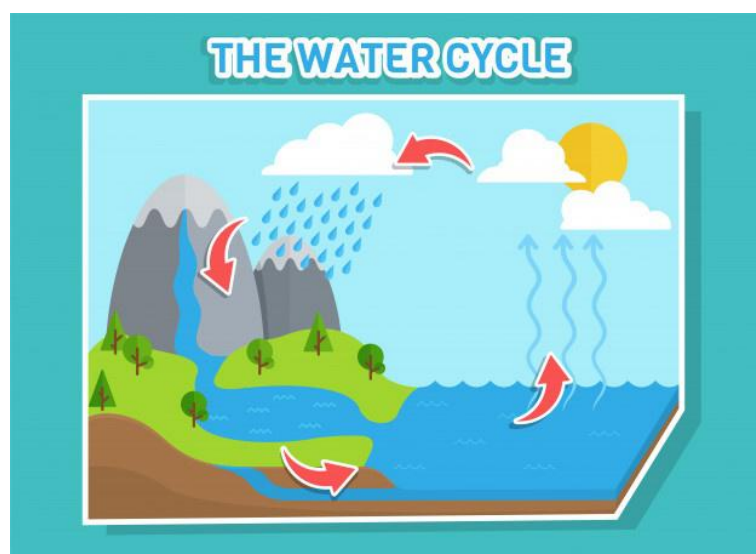

The Water Cycle and Other Cycles

The water cycle drives the interaction among the lithosphere, biosphere, hydrosphere, and atmosphere on the earth, and is the "tie" that connects the earth's circles and various water forms.

The water cycle is a "regulator", it regulates the energy among the various layers of the earth, and plays an important role in the change of cold and warm climate. The water cycle is the "sculptor", which shapes the colorful surface forms through erosion, transportation and accumulation. The water cycle is the "conveyor belt", it is the powerful driving force and main carrier of the surface material migration. More importantly, through the water cycle, the ocean continuously delivers fresh water to the land, supplementing and renewing fresh water resources on the land, thus making water a renewable resource.

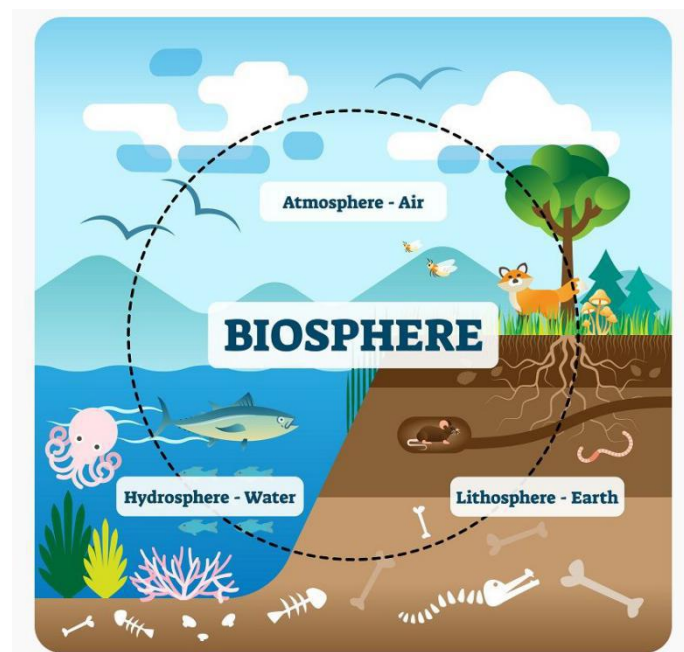

Conclusion

In this project, we started from "where does the rain come from, and where does it go?", through a cup of ice water, observed the phenomenon of water movement. Then built a simple water cycle model, explored the formation process of the water cycle, and learned the knowledge of water and water cycle.

The project is going to an end, please remove cables, and put all the BOSON modules back into the kit according to the corresponding position.

Extend

1. Water will become larger when it freezes into ice. Why is this? Try to explain from the perspective of water molecules.
2. In autumn and winter mornings, heavy fog often affects our sight. Do you know how the fog is formed?
3. Why do we feel the air more humid in places with many trees?

LESSON 8: Solar Oven

Introduction



Standards

NGSS

4-PS3-2 Make observations to provide evidence that energy can be transferred from one place to another via sound, light, heat, and current.

4-PS3-4 Use scientific concepts to design, test and improve the equipment that can transform energy from one form to another.

Science - Grade 3-5

Overview

We all love barbecues, but smoke produced by grilling often contains pollutants that damage health. Can we utilize pollution-free solar energy to cook food? In this lesson, we are going to make a solar oven to cook chocolate sandwich biscuit based on the principle of light reflection.

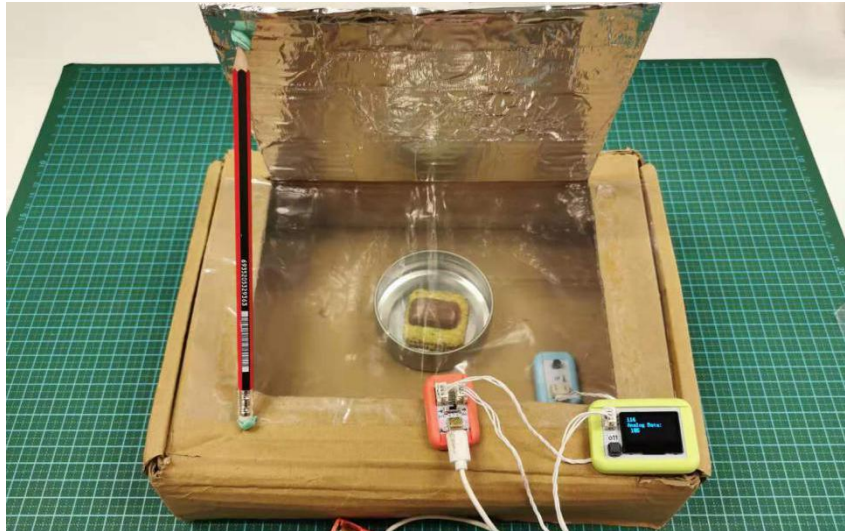



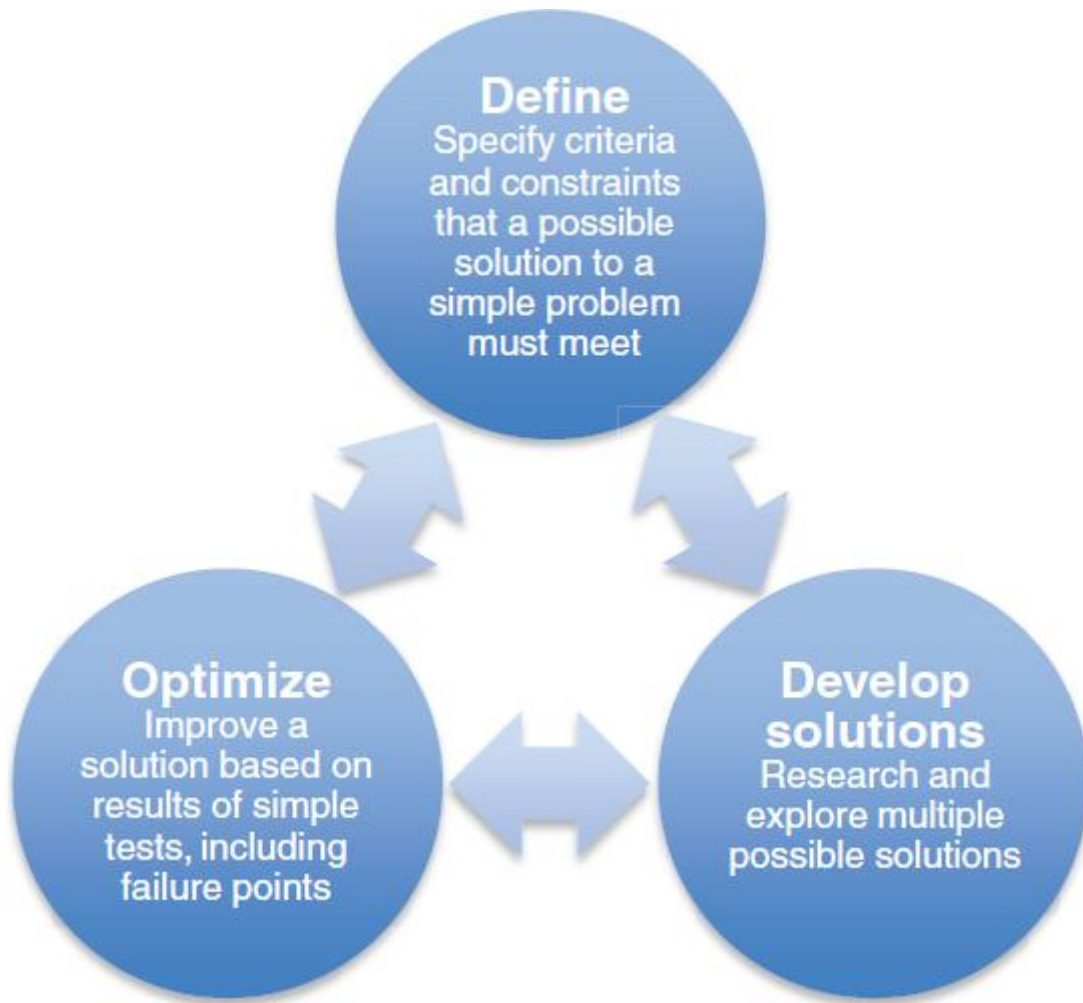

According to the NGSS standard engineering design requirement in 3-5 grades, the course is divided into 3 parts, they are respectively “DEFINE ENGINEERING PROBLEMS, DEVELOPING POSSIBLE SOLUTIONS, OPTIMIZING THE DESIGN SOLUTION” . Just like engineers, students will find problems, set goals, design plans, build and test models, optimize and improve models, and finally complete the engineering design task.



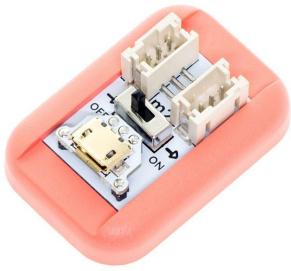











Materials

BOSON Module	Image	Function
Battery Holder (3x AAA batteries installed)		4.5V Power Supply

MainBoard-1IO (m2)		Provide power for other modules
Temperature Sensor (i11)		Measure the temperature in the oven
Display Module(o11)		Provide visible effect for users to check results
BOSON cable *2		Use with 3-Pin Fool-proof connector to connect other modules

Additional Materials	Image	Function
----------------------	-------	----------

<p>Pizza Box</p>		<p>Used to build the oven</p>
<p>Aluminum Foil</p>		<p>Used to reflect sunlight to make a reflective device</p>
<p>Plastic Wrap</p>		<p>Used to seal the pizza box to prevent heat loss</p>
<p>Double Sided Adhesive Tape</p>		<p>Used to stick the plastic wrap and aluminum foil to the pizza box</p>
<p>Paper Knife</p>		<p>Used to cut the pizza box (can be replaced by scissor)</p>
<p>Ruler</p>		<p>Used to measure the size</p>
<p>Pencil</p>		<p>Used to mark the cut position (can be)</p>

		replaced by pen)
Newspaper		Roll up the newspaper and place it around the pizza box to prevent heat loss
Metal Roasting Pan		Used to hold food
Chocolate		Food to be cooked in the oven
Biscuit		Food to be cooked in the oven
Lamp		When the outdoor light is not good, use a desk lamp as a supplementary light source

Blue Tack		Used to fix the sensors and other materials
Black Paper		Used to absorb heat generated by sunlight

Activity 1 DEFINE ENGINEERING PROBLEMS

Find Problems

Have you ever cooked outdoors? When grilling or camping outdoors, charcoal is often burned to heat food. This will pollute the environment to a certain extent. Is there an environmentally friendly method?

In the previous project, we have learned the concept of energy. Many kinds of energy can be converted into heat energy. For example, when burning charcoal, the chemical energy of charcoal is converted into heat energy. Think about it, what other energy can be converted into heat? Can it be convenient for us to cook food outdoors without polluting the environment?

Solar energy is a good choice. The sun's radiation can heat objects. Let's make a solar oven together!



Engineering Goals

Make a solar oven to cook food with the Sun.

Activity 2 DEVELOPING POSSIBLE SOLUTIONS

After determining the engineering goals, let us follow the process of “Brainstorming-Drawing Prototype Diagram-What You Need-What You Do-Test and Evaluate” to develop a solution and complete the building of a solar oven.

Brainstorm

Let’ s first brainstorm how to build a solar oven. In the process, try drawing a prototype of the solar oven.

Question	Referable Answer
1. What is the function of the solar oven?	Heat food with the sun.
2. How can we make a solar oven?	We can use a box as an oven, imitating the oven at home.







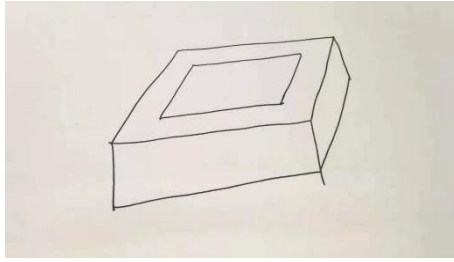



	<p>Also, we need to make an opening at the top cover of the box to allow direct sunlight to enter and heat the food.</p>
<p>3. How can we prevent heat loss?</p>	<p>Let the oven have insulation properties.</p> <p>For example, covering the opening of the top cover with a transparent plastic film can not only allow sunlight to pass through, but also prevent heat loss.</p> <p>Or, spreading multiple layers of old newspapers in the oven, which is like wearing many layers of clothes in winter to prevent heat loss.</p>

Prototype Drawing

In the brainstorming, we have initially understood the function and structure of the solar oven. Try drawing a prototype diagram. In the production process, the prototype diagram will be an important reference.



What You Need

		
<p>Pizza Box</p>	<p>Pencil</p>	<p>Paper Knife</p>
		
<p>Metal Roasting Pan</p>	<p>Chocolate</p>	<p>Biscuit</p>
		
<p>Double Sided Adhesive Tape</p>	<p>Plastic Wrap</p>	<p>Newspaper</p>
		
<p>Ruler</p>		

What You Do

1. Prepare a clean pizza box, a pencil and a ruler. Draw a square at the top of the pizza box, whose sides are 3cm away from the edge of the box.



2. Prepare a paper knife. Cut the square carefully along the three lines just drew, and then slightly fold back the flap along the connected side to allow the sunlight to enter the box.



Note: Do not cut off the flip cover completely.

3. Prepare plastic wrap and double sided adhesive tape. Cover the opening of the box with plastic wrap, and stick the plastic wrap on the box with double sided adhesive tape.



Make sure that there are no holes in the wrap and that all edges of the wrap completely cover the opening.

4. Prepare some newspaper. Open the top cover of the pizza box, roll some newspaper into a tube, and stuff it into the sides of the box.



5. Prepare chocolates, biscuits and a metal pan. Put the chocolate on the biscuits, and then place them on the metal pan, put the pan in the pizza box, and cover the top of the box.



Test and Evaluate

With the above steps, a simple solar oven is completed! On a shining day in the summer, at about 12 o'clock and 3 o'clock, put the solar oven

outside, then we can enjoy delicious chocolate sandwich biscuits after a while!

Do you think solar ovens can be optimized? Can the oven collect more sunlight to heat the food? Try to propose an optimization plan to improve the efficiency of the solar oven.

Activity 3 OPTIMIZING THE DESIGN SOLUTION

Let us continue the process of “ Brainstorming-Drawing Prototype Diagram -What You Need-What You Do-Test and Evaluate” to carry out optimization and iteration of solar ovens.

Brainstorm

Question	Referable Answer
1. How to heat food faster?	If more sunlight is available, food can be heated faster.
2. How to get more sunshine?	You can get more sunlight by increasing the area irradiated by sunlight, or gathering sunlight in one place by reflection. However, increasing the sun exposure area means a bigger oven is required, which will cause heat loss easily.
3. How to get more reflected light?	Add a reflective device so that the

	surrounding sunlight can be collected in the oven through reflection.
4. How to make a reflective device?	Aluminum foil is a great reflective material, which can be just stucked and fixed at the inner side of the flip at the top of the box, as a reflective device.
5. How to check the efficiency of the solar oven?	Measure the temperature change in the oven in real-time with BOSON temperature sensor to get the efficiency of the oven.

Prototype Drawing

Through brainstorming, we optimize the design of the solar oven, try optimizing the prototype figure, and mark the materials and functions of each part.

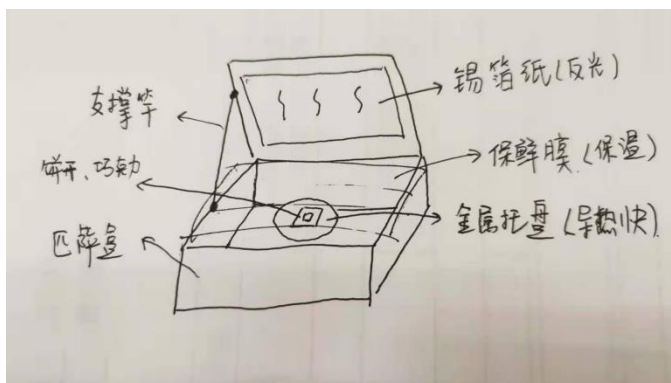

What You Need

Prepare the following BOSON modules and other materials.

		 <p>Temperature Sensor (i11)</p>
<p>Display Module(o11)</p>	<p>MainBoard-1IO (m2)</p>	
		<p>BOSON cable *2</p>
<p>Battery Holder (3x AAA batteries installed)</p>		
		
<p>Aluminum Foil</p>	<p>Blue Tack</p>	<p>Lamp</p>

What You Do

1. Prepare BOSON modules.
Build an experimental circuit to realize the function of reading temperature.

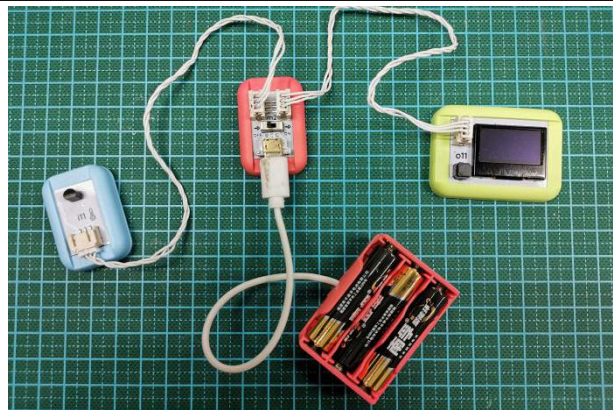

2. Prepare aluminum foil and double sided adhesive tape.
Cover the inner side of the paper board with the foil and make it as smooth as possible.
Fold the excess foil to the other side of the cardboard and fix it with double sided adhesive tape.



3. Prepare a pencil and blue tack. Use the pencil as support and fix the flip with blue tack.



4. Prepare blue tack. Tear one corner of the plastic wrap, fix the BOSON temperature sensor in the pizza box with blue tack, and then restore the wrap.



5. Prepare blue tack. Fix the BOSON display and other BOSON modules at the edge of the pizza box with blue tack. In order to quantify the efficiency of the solar oven, we need to check the temperature in the solar oven and the degree of melting of the chocolate at regular intervals and record them in the table below.



The table of temperature change of the solar oven:

Time	0min	10min	20min	30min	40min
Temperature					
Melting Degree of					

the Chocolate					
---------------	--	--	--	--	--

Test and Evaluate

On a shining day in the summer, at about 12 o'clock and 3 o'clock, put the solar oven under the sun. We can enjoy delicious chocolate sandwich biscuits after a while! If the weather is not so good, we can also use a warm-light lamp as the light source to continue the experiment.

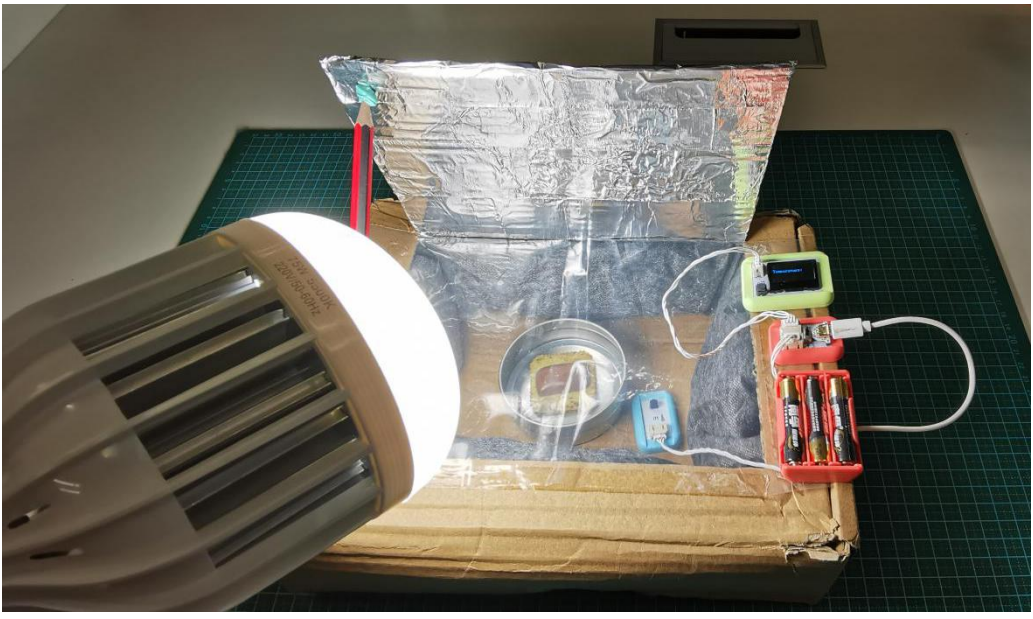

Note 1: If it is in a hot summer, the temperature of the solar oven may be very high. Remind students to use anti-scalding gloves to prevent burns.

Note 2: Chocolate will not melt until it is above 30 degrees. If it is in the cold winter, the room temperature is low and the temperature of the solar oven does not reach 30 degrees, the chocolate will not melt. In winter, we can change this lesson into "solar plant greenhouse". The goal is to use solar energy to create a warmer living environment for plants in

the cold winter. Please pay attention to the ventilation of the experimental device this time.

What Happened?

When the lights from the sun reaches the earth, they are reflected by the aluminum foil and pass through the plastic wrap, heating the air inside the pizza box, so the temperature in the pizza box will rise, just like a car gets hot in summer. The newspaper in the pizza box plays a role in insulating.

Compared to traditional ovens, solar ovens are a low-cost and eco-friendly technology. Although it takes a longer time to cook, it does work.



Explore Further

In this activity, we made a very simple solar oven, and we can also try adjusting many variables in the solar oven design to make it better. Such as changing the angle of the reflector baffle, or using color with better heat-absorbing ability in the oven to improve the efficiency of the solar oven.

Different colors have different heat absorption abilities. If a piece of black paper is put at the bottom of the oven, can the efficiency of the solar oven be improved? Let's continue to explore it!



Science Background

Which color absorbs the most heat?

When light hits on an object, three things happen: part of the light can be absorbed by the object, part of the light can be reflected by the object, and part of the light can continue to spread through the object.

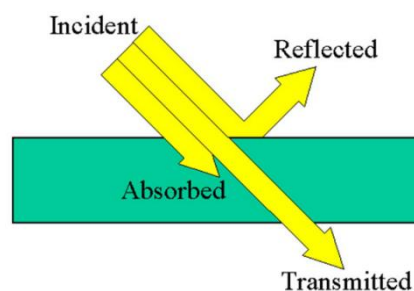

Different colors reflect and absorb light differently. Dark colors, especially black, will absorb light more, and the absorbed light will be converted into heat. Light colors reflect light more easily and absorb less light. This is why wearing a black shirt in summer feels hotter than

wearing a white one!

Conclusion

In this project, we made a solar oven using the pizza box, plastic wrap, and newspaper. With the knowledge of light reflection, we optimize the design of the oven. In further exploration, we have mentioned that the efficiency of the oven can be improved with the change of the angle of the reflector baffle and the choose of a better color in heat absorption.

The project is going to an end, please remove cables, and put all the BOSON modules back into the kit.

LESSON 9: Fridge Door-closing

Reminder

Introduction

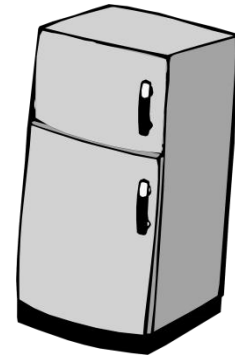

Standards

NGSS

4-PS3-2 Make observations to provide that energy can be transferred from one place to another via sound, light, heat and current.

4-PS3-4 Use scientific concepts to design, test, and improve equipment that can transform energy from one form to another.

Science - Grade 3-5

Overview

In these busy times it is now common to forget to close the fridge door. This lesson will lead students to explore how to make a fridge door-closing reminder, and determine the proper height the temperature sensor should be positioned at based on the principle of hot air rising and cold air falling.





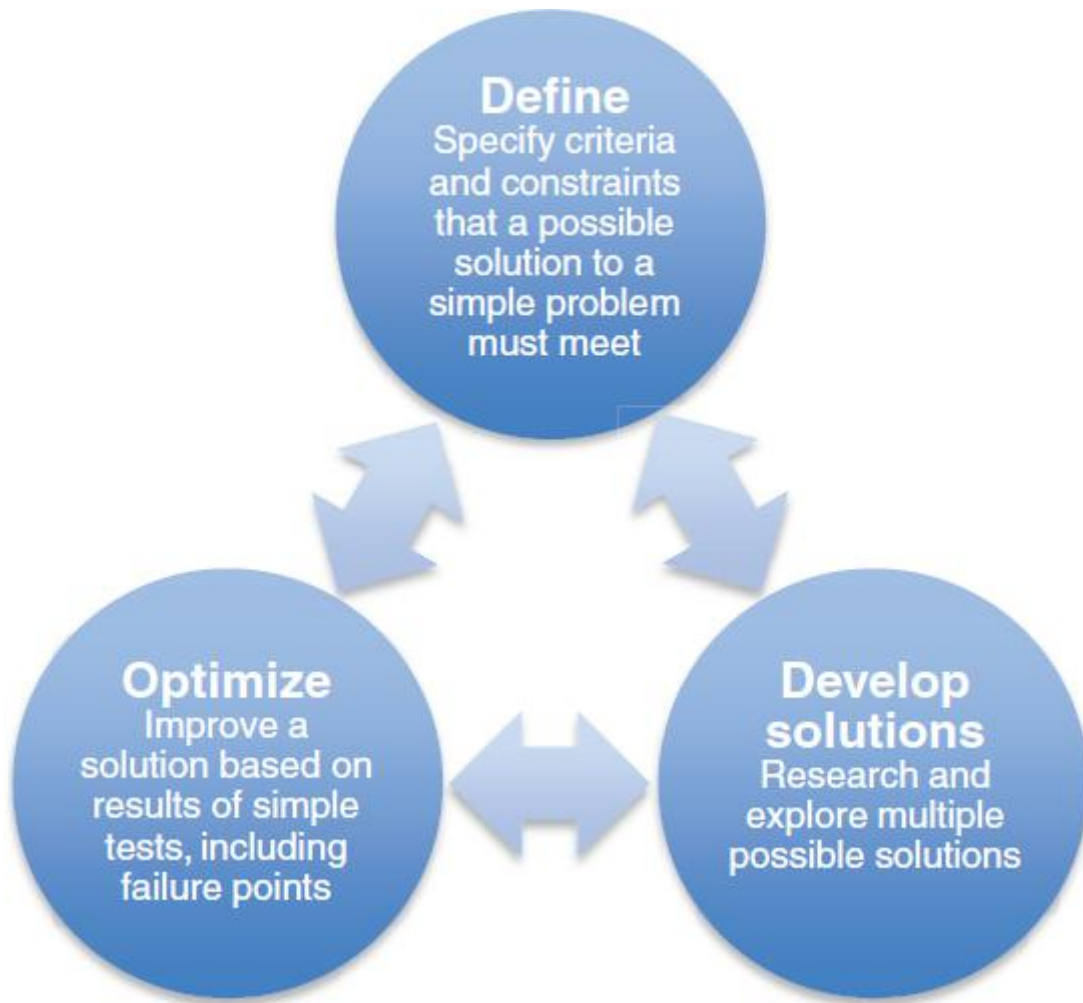



According to the NGSS standard engineering design requirement in 3-5 grades, the course is divided into 3 parts, they are respectively “DEFINE ENGINEERING PROBLEMS, DEVELOPING POSSIBLE SOLUTIONS, OPTIMIZING THE DESIGN SOLUTION” . Just like engineers, students will find problems, set goals, design plans, build and test models, optimize and improve models, and finally complete the engineering design task.

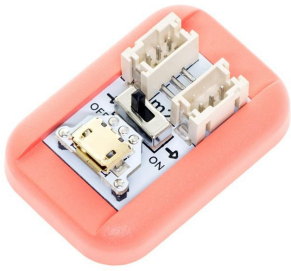



Materials

BOSON Module	Image	Function
Battery Holder (3x AAA batteries installed)		4.5V Power Supply

<p>MainBoard-1IO (m2)</p>	 <p>A small electronic module with a white PCB and a red plastic housing. It features a 2-pin header on the left and a 4-pin header on the right. A small black component is visible on the board.</p>	<p>Provide power for other modules</p>
<p>Temperature Sensor (i11)</p>	 <p>A small electronic module with a white PCB and a light blue plastic housing. It features a 2-pin header on the left and a black cylindrical temperature sensor on the right.</p>	<p>Measure the temperature</p>
<p>Buzzer Module(o5)</p>	 <p>A small electronic module with a white PCB and a light green plastic housing. It features a 2-pin header on the left and a black circular buzzer on the right. A label on the buzzer reads "REMOVE SOLDER WASHINGS".</p>	<p>Make sound</p>
<p>Logic Module - NOT(f3)</p>	 <p>A small electronic module with a white PCB and a yellow plastic housing. It features a 2-pin header on the left and a 4-pin header on the right. A small black component is visible on the board.</p>	<p>When the input signal is "off" or "0", the module outputs "on" or "1".</p> <p>When the input signal is "on" or "1", the module outputs "off" or "0".</p>

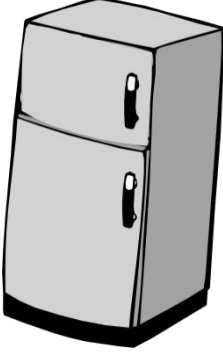
Threshold Module(f6)		Used as a threshold switch to change state when the input exceeds the threshold.
BOSON cable *4		Cooperate with 3-Pin fool-proof interface to connect other modules

Additional Materials	Image	Function
Refrigerator		The experimental object, used to verify and optimize the project.
Stopwatch		Record the time in the process of optimizing the design.

Activity 1 DEFINE ENGINEERING PROBLEMS

Find Problem

In the hot summer, when we open the refrigerator and take out the delicious ice cream, we leave with the door open. After a while, when we come to the refrigerator again, we will find the delicious ice cream melted. Oh, what a terrible experience!

Why not make a refrigerator door-closing reminder? This is a good idea, let' s do it!



Engineering Goals

Make a refrigerator door-closing reminder.

Activity 2 DEVELOPING POSSIBLE SOLUTIONS

After determining the engineering goals, let us follow the process of

“Brainstorming-Drawing Prototype Diagram-What You Need-What You

Do-Test and Evaluate” to complete the making of the refrigerator door-closing reminder.

Brainstorm

Let’ s first brainstorm how to build a refrigerator-closing reminder. In the process, try drawing a prototype of the reminder.

Question	Reference Answer
1. What is the function of the refrigerator door-closing reminder?	Remind us to close the refrigerator when we forget.
2. How can we make a refrigerator-closing reminder?	Observe the difference when opening or closing the refrigerator door. Use the BOSON module to build an intelligent device to detect whether the refrigerator door is closed.
3. What is the difference between opening or closing the refrigerator door? How to detect it?	Difference 1: When the refrigerator door is opened, the cold air will run out, which will lower the temperature around the refrigerator. Using BOSON temperature sensor to detect the

temperature changes, you can determine whether the refrigerator door is open.



Difference 2: When the refrigerator door is opened, the light in the refrigerator will turn on. Use BOSON light sensor to detect the light changes, then you can determine whether the refrigerator door is open.



4. How to send a reminder?

Remind us with sound so as to attract attention. The BOSON buzzer is a sounding device that can send an alarm to remind us.



5. Which method is better?

Let's analyze the usage scenarios of the two methods first.

When the temperature sensor is used and the refrigerator door is opened for a long time, the surrounding temperature will decrease, which will make the reminder device send a prompt after the refrigerator door is forgotten to be closed for a while.

When using light sensor, every time the refrigerator is turned on, the light is on, so every time the refrigerator door is opened, a reminder will be sent until the refrigerator door is closed.

Then, let's analyze the usage time.

When using the temperature



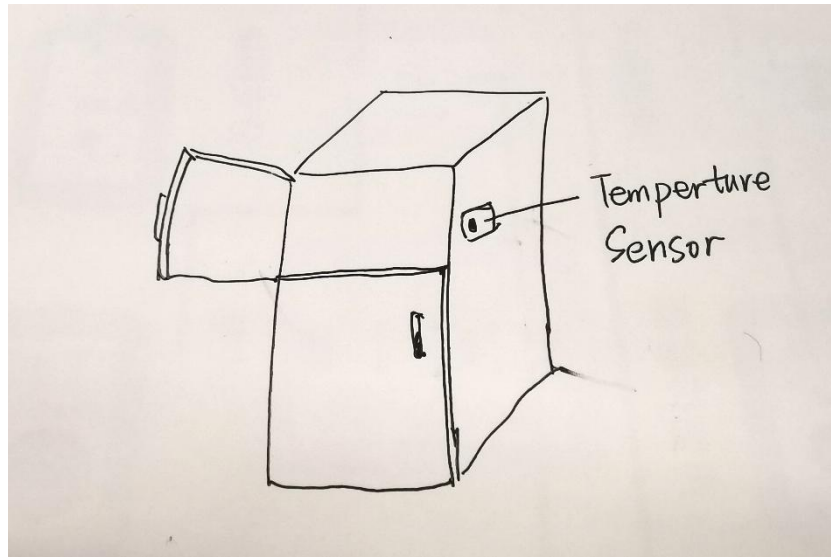

	<p>sensor, if it is in the hot summer, opening the refrigerator door will significantly reduce the surrounding temperature. If it is a cold winter, the temperature will not change much.</p> <p>When using the light sensors, there is no need to consider seasonal changes.</p> <p>After a comprehensive analysis, we learn that it is better to use a temperature sensor in summer and a light sensor in winter.</p> <p>In the following project, we take the temperature sensor in summer as an example.</p>
--	--

Draw Prototype Diagram

Through brainstorming, we have initially understood the function and structure of the refrigerator door-closing reminder. Try drawing a prototype diagram. In the production process, the prototype diagram will be an important reference.

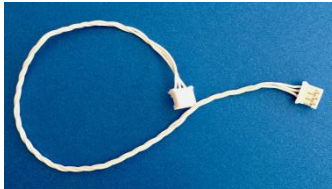

What You Need

 <p>MainBoard-1IO (m2)</p>	 <p>Buzzer Module(o5)</p>	 <p>Threshold Module(f6)</p>
 <p>Logic Module - NOT(f3)</p>	 <p>Temperature Sensor (i11)</p>	 <p>BOSON cable *4</p>



Battery Holder (3x AAA batteries installed)

What You Do

1. Prepare the BOSON module.

According to the picture on the right, build an experimental circuit to realize the function of controlling the buzzer with temperature.

2. Turn the switch of the main control board to ON and observe whether the buzzer sounds.

In this circuit, the buzzer basically does not make a sound. At this time, we can add a threshold module to set the critical temperature value

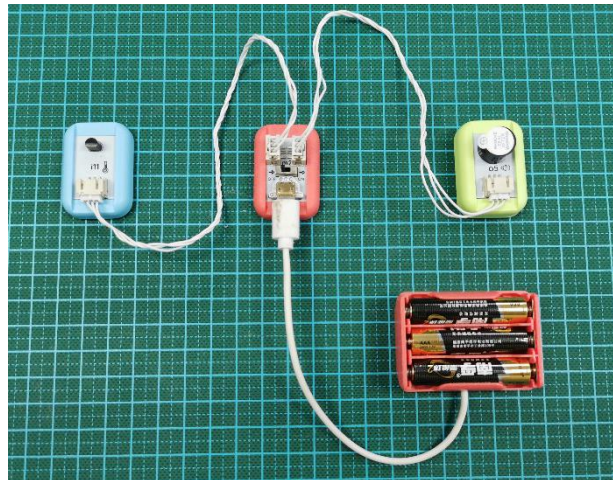

to make a sound.

3. Add the Threshold Module and complete the circuit connection according to the figure on the right.

There are "+" and "-" signs next to the blue knob of the Threshold Module, indicating the size of the set threshold.

Turn the knob arrow to "-" to decrease the set critical value.

When the critical value is less than the feedback value from the current temperature sensor, the buzzer will buzz.

On the contrary, turning the knob to "+" will increase the critical value, and the buzzer will no longer sound.

Note: Connect the Threshold Module in the direction of the arrow.

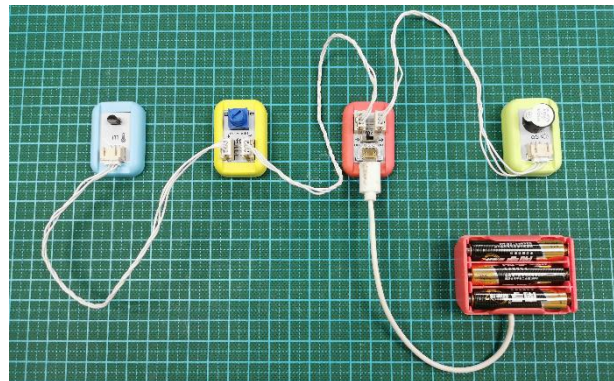

4. Turn the blue knob of the Threshold Module until the buzzer just doesn't make sound. At this time, hold the black detector of the temperature sensor to raise the temperature, and it can be found that the buzzer immediately emits a sound.

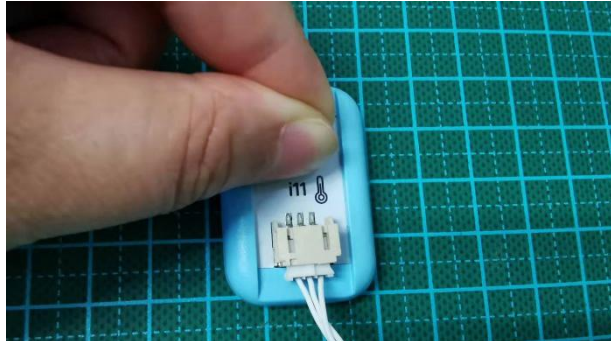

5. In the refrigerator door closing reminder, we should let the buzzer sound when the temperature drops. So, add Logic Module-NOT and complete the circuit connection according to the figure on the right.

Note: Connect Logic Module-NOT in the direction of the arrow.

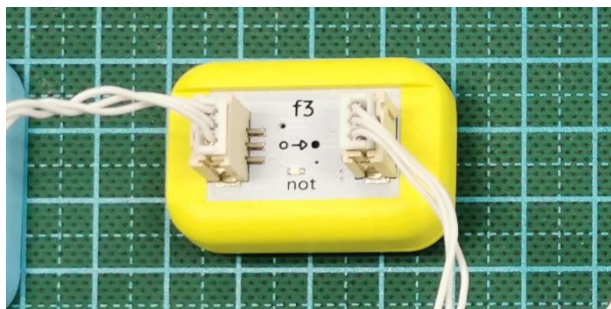
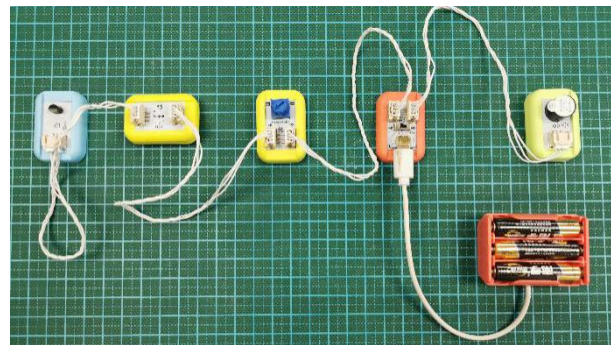

6. Open the refrigerator door for a period of time, put the device near the refrigerator, and fix it on the refrigerator by magnetic attraction.

Turn the blue knob on the Threshold Module to set a temperature threshold. When the temperature is lower than this value, the buzzer will buzz to alert people.



Test and evaluate

After the above steps, a simple refrigerator door-closing reminder is completed! Now try it to test its performance.

When fixing the temperature sensor, will the experiment result be different when the sensor is placed at different heights? Which height will give the best result? Try proposing an optimization plan to improve the response speed of the reminder.

Activity 3 OPTIMIZING THE DESIGN SOLUTION

Let us continue the process of “Brainstorming-Drawing Prototype Diagram -What You Need-What You Do-Test and Evaluate” to carry out optimization and iteration of fridge door-closing reminder.

Brainstorm

Question	Reference Answer
1. How to improve the response speed of the reminder?	If the temperature change can be detected faster, the response speed can be improved.
2. After opening the refrigerator door, will the temperature decrease at the same speed at different heights of the refrigerator door? How to detect it?	We guess that the temperature change speed is different at a different height. We can set up a comparative experiment to find out the height where the temperature changes fastest.

What You Do

Through brainstorming, we guessed that after opening the refrigerator door, the temperature changes at different heights of the refrigerator. Fixing the temperature sensor at the height with the fastest temperature change can increase the response speed of the reminder. Is it true? Let's verify it together!

1. As shown in the picture on the right, select 3 positions at different heights of the refrigerator door.

First, fix the temperature sensor at position 1, and take the time when the refrigerator door is opened as the starting time. Use a stopwatch to record the response time of the buzzer sound, and record it in the table below.

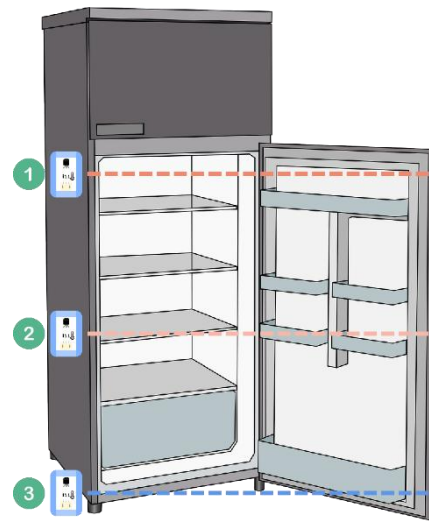

2. Place the temperature sensor at position 2 and position 3, repeat the above operation, and record the data in the table below.

The table of the response time of the reminder:

Position	Response time (unit: second)
1	
2	
3	

Note: In the actual experiment, you can allow 3 groups of students to conduct experiments at different positions of the refrigerator door at the same time, and finally gather the data together to save experiment time.

Test and evaluate

The referable data is as follows:

Position	Response time (unit: second)
1	501
2	262
3	105

Through 3 sets of comparative experiments, we can conclude that the temperature at the bottom of the refrigerator changes fastest, which is the best position to fix the temperature sensor.

What happened?

In the hot summer, the air temperature in the refrigerator is low, and the air temperature in the environment is high. When we open the refrigerator door, due to the temperature difference, the cold air and the hot air will transfer heat through heat convection. So, the air near the refrigerator door will cool down.

Just like a hot air balloon will rise, near the refrigerator, the hot air will rise and the cold air will drop, so the lower part near the refrigerator will be colder.



Further Exploration

In this activity, we made a very simple refrigerator door -closing reminder, but it can only be used in summer. Think about it, if in winter, is there a better solution? Let' s continue to explore it!

Science Background

Why do hot air rise and cold air fall?

Air is made up of many invisible molecules.

In hot air, the molecules move fast and collide with each other, increasing the space around them, so the hot air will expand. After expansion, there are fewer molecules and lighter weight per unit volume, so the hot air will rise.

In cold air, the molecules move slow, and there are more molecules and heavier weight per unit volume, so the cold air will drop.

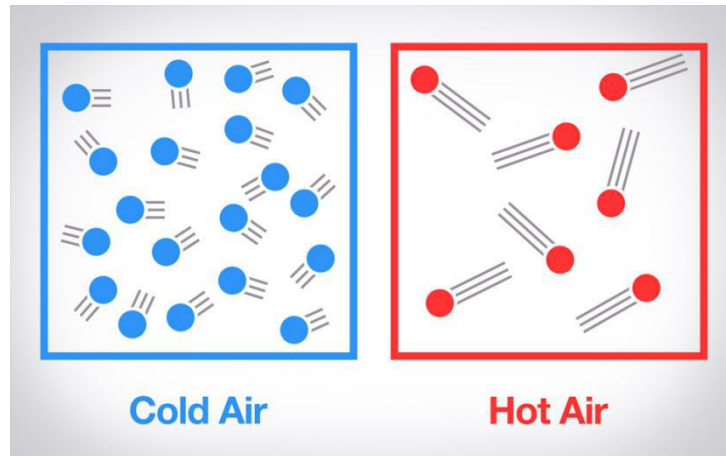

Hot air balloon and Kongming lantern

Hot air balloons in Turkey and Kongming lanterns in China both use the principle of hot air rising.



Conclusion

In this project, we made a refrigerator door-closing reminder, and optimized the design of the reminder by using the knowledge of hot air rising and cold air falling.

The project is going to an end, please remove cables, and put all the BOSON modules back into the original positions of the kit.

LESSON 10: Automatic Plants Fill Light



Introduction

Standards

NGSS

5-PS3-1 Use models to describe that the energy in animals' food (used for body repair, growth, movement, and to maintain body warmth) was once from the sun.

3-LS3-2 Use evidence to support the explanation that traits can be influenced by the environment.

Science - Grade 3-5

Overview

The shortage of sunlight often slows the plants growth down significantly. In this lesson, students will discuss how to solve the problem of lack of sunlight in a greenhouse in winter or rainy days, and try making an automatic light fill device to help plants grow better!





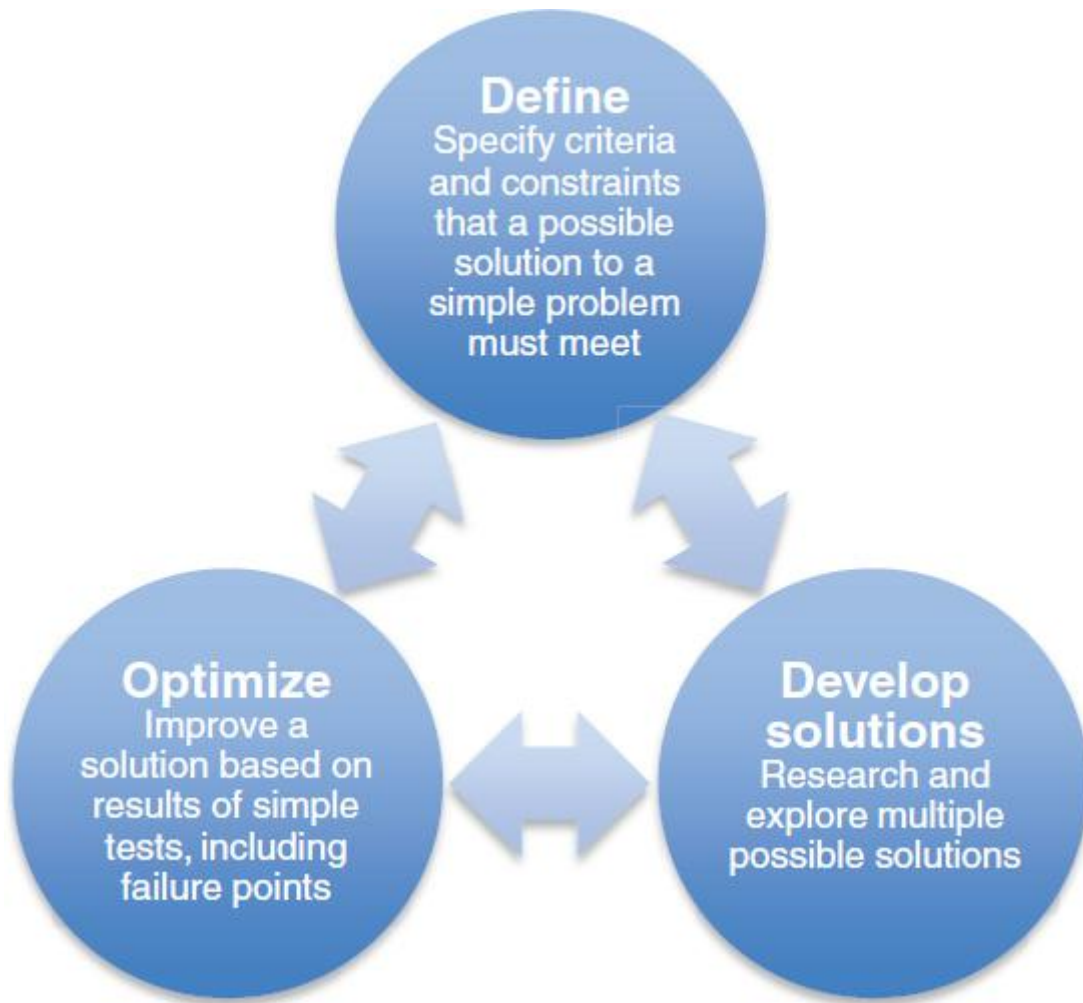

According to the NGSS standard engineering design requirement in 3-5 grades, the course is divided into 3 parts, they are respectively “DEFINE ENGINEERING PROBLEMS, DEVELOPING POSSIBLE SOLUTIONS, OPTIMIZING THE DESIGN SOLUTION” . Just like engineers, students will find problems, set goals, design plans, build and test models, optimize and improve models, and finally complete the engineering design task.



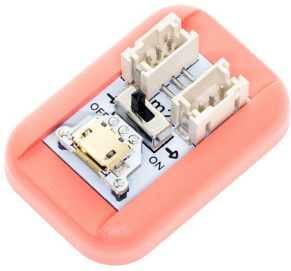

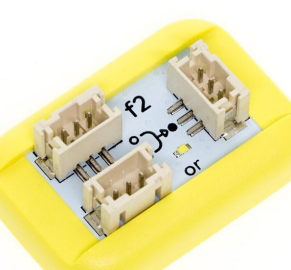

Materials

BOSON Module	Image	Function
Battery Holder (3x AAA batteries installed)		4.5V Power Supply

MainBoard-1IO (m2)		Provide power for other modules
Light Sensor (i4)		Measure the intensity of ambient light
Yellow Push Button (i2y)		Switch button
Ultra-bright LED(o1)		The simplest white light-emitting module. Brightness can be adjusted.
Logic Module - OR(f2)		This module can process the two input signals and combine them into one signal.

		<p>The input and output mechanism are as follows:</p> <p>When the input signal at one or both ends is "on" or "1", the module outputs "on";</p> <p>If and only when the input signal at both ends is "off" or "0", the module outputs "off".</p>
<p>Logic Module - NOT(f3)</p>		<p>When the input signal is "off" or "0", the module outputs "on" or "1".</p> <p>When the input signal is "on" or "1", the module outputs "off" or "0".</p>

Threshold Module(f6)		Used as a threshold switch to change state when the input exceeds the threshold.
BOSON cable *6		Cooperate with 3-Pin fool-proof interface to connect other modules

Additional Materials	Image	Function
Potted plants		The experimental object.
LEGO blocks		Used to build a bracket to fix the sensor

Activity 1 DEFINE ENGINEERING PROBLEMS

Find Problem

In cold winter, fresh fruits and vegetables cannot grow naturally, and often need to be planted in warm greenhouses. However, the sunshine time in winter is short and there are often cloudy days, plants are hard to grow in such conditions. How to solve this problem? Let's find out a solution together!



In the previous project, we talked about that the point of direct sunlight will change in winter. This is the time of the year when the sun is slanting the strongest, so the light is very weak and the sunshine period is short. In order to solve the problem of lack of light in greenhouse, we can design a device that automatically supplies light for plants, let's try it together!

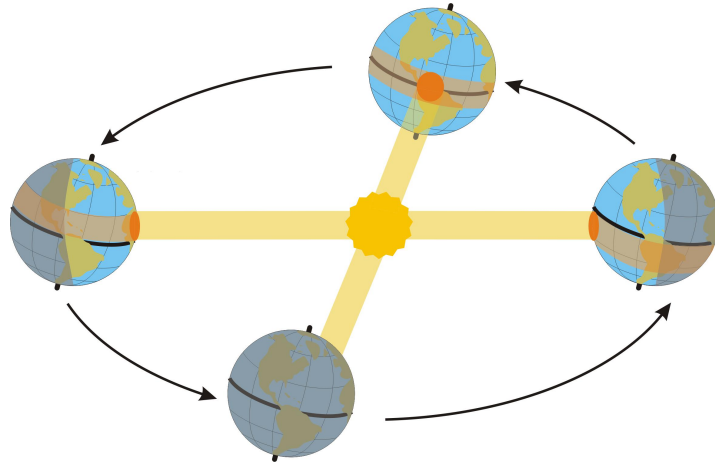

Engineering Goals

Make an automatic light-supplying device for plants.

Activity 2 DEVELOPING POSSIBLE SOLUTIONS

After determining the engineering goals, let us follow the process of “Brainstorming-Drawing Prototype Diagram-What You Need-What You Do-Test and Evaluate” to develop a solution and complete the building of auto light-supplying device.

Brainstorm

Let’ s first brainstorm how to build an automatic light-supplying device. In the process, try drawing a prototype of the automatic light-supplying device.

Question	Reference Answer
1. What is the function of the automatic light-supplying device?	When the sunlight is weak, it will automatically supply light for the

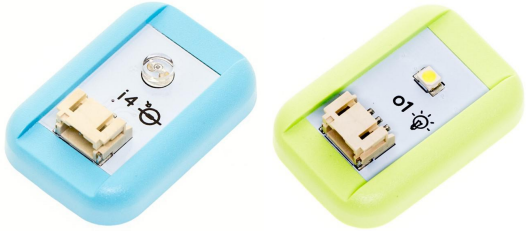
	plants.
2. How to determine whether the sunlight is sufficient? How to achieve light supplying?	<p>Use the light sensor to judge the intensity of the light. When the light is weak, use the fill-in lamp to supply plants with light.</p> 
3. How to make the automatic light-supplying device	<p>To build the circuit with BOSON module, a bracket is also needed to fix the BOSON module.</p> <p>Place the device next to the plants, the light sensor is facing the sun to facilitate detection of light changes, and the fill-in lamp is facing the plants to facilitate the light supplement.</p>





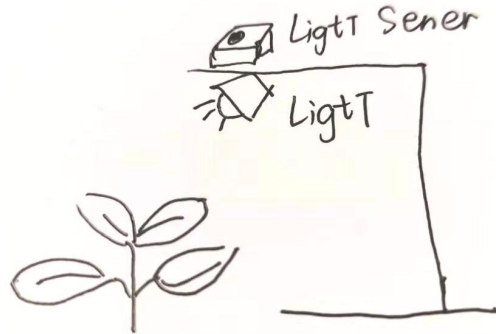

Raw Prototype Diagram

In the brainstorming, we have initially understood the function and structure of the automatic light-supplying device. Try drawing a

prototype diagram. In the production process, the prototype diagram will be an important reference.



What You Need

		
MainBoard-1IO (m2)	Light Sensor (i4)	Ultra-Bright LED(o1)
		
Logic Module - NOT(f3)	Threshold Module(f6)	Battery Holder (3x AAA batteries installed)

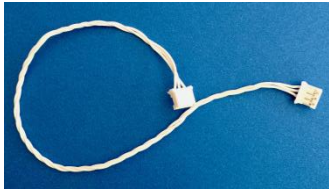

BOSON cable *4



Potted Plants



LEGO Blocks

What You Do

1. Prepare the BOSON module. According to the picture on the right, build an experimental circuit to realize the function of turning on the light when the light is weak.

Note: Connect the threshold module and logic NOT module in the direction of the arrow on the module.

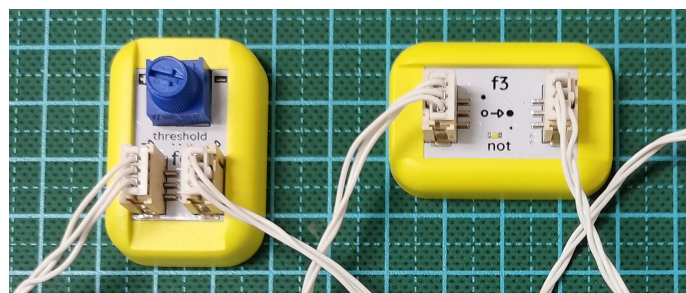
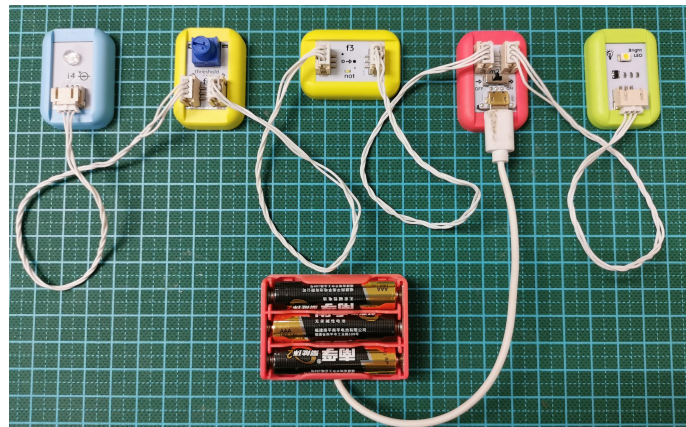

2. Turn the switch of the main control board to ON, and adjust the blue knob of the threshold module to make the LED light just change from on to off.

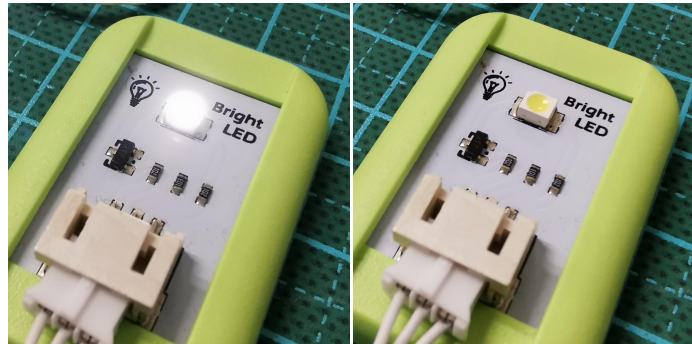

3. At this time, cover the transparent probe of the light sensor with your hand, you can find that the LED light becomes brighter when the ambient light gets darker.

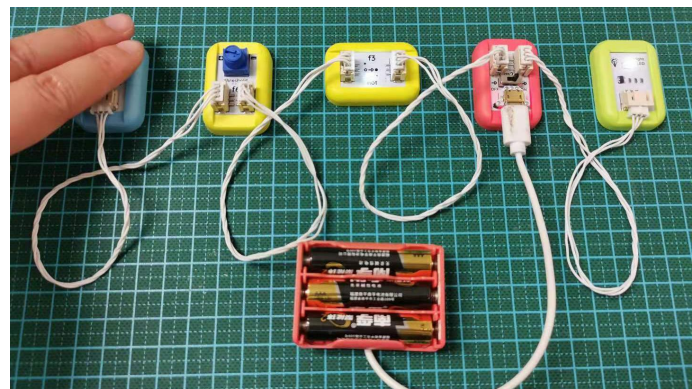

4. Prepare LEGO blocks and blue tack. Build a LEGO bracket to fix the sensor and LED lights.

Note: Fix BOSON module to the LEGO base, and fix the module on the inclined surface with blue tack.

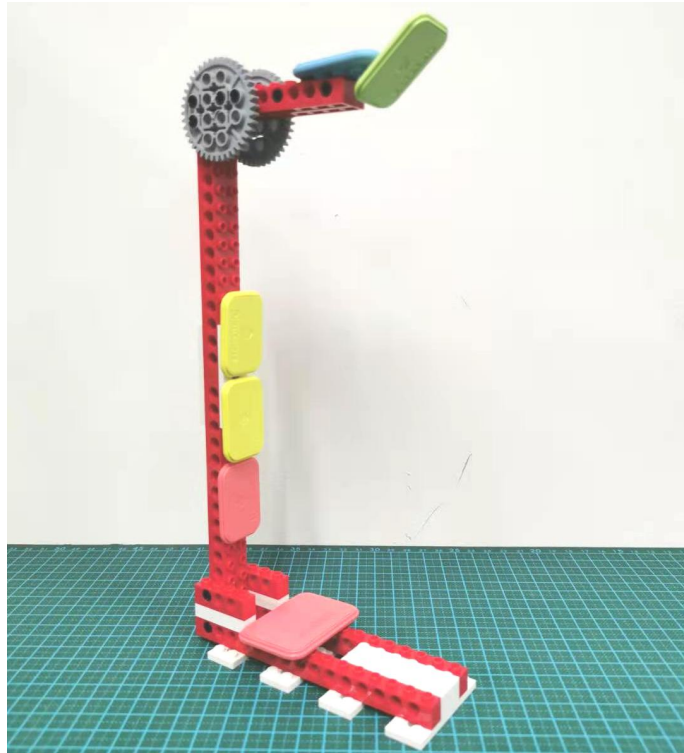

5. Fix the BOSON module on the Lego bracket. The light sensor is fixed on the top of the bracket, and the transparent probe of the sensor is upward.

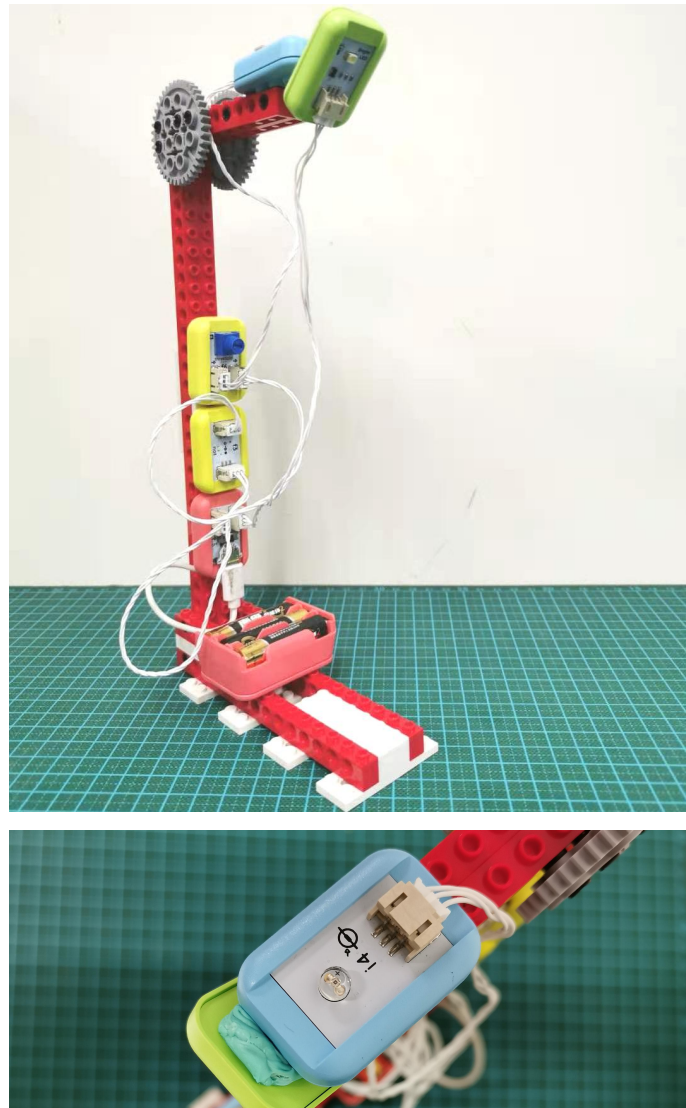

Test and evaluate

After the above steps, a simple automatic light-supplying device is done!
Put it next to the plants, when the light sensor detects that the light is weak, it will automatically turn on the LED light to supply light.



Do you think there is still something to be optimized for the device? Can the supplement be achieved manually? For example, by pressing a switch, you can manually turn on the lamp. Try to come up with an optimization plan.

Activity 3 OPTIMIZING THE DESIGN SOLUTION

Let us continue the process of “Brainstorming-Drawing Prototype Diagram -What You Need-What You Do-Test and Evaluate” to carry out optimization and iteration of light-fill device and add manual controlling function.

Brainstorm

Question	Reference Answer
----------	------------------

1. How to manually control the device?

A button can be added. Press the button to turn on the fill-in lamp.



2. How to realize manual control and automatic control at the same time?

The BOSON logic OR module can process and combine the two input signals, and output into one signal. As long as any one of the two input signals is satisfied, it will trigger the module to output signal.

Based on the original experimental circuit, adding logic OR modules to let the device work manually and automatically.



What You Need

Based on the above activities, add the following BOSON modules and other materials.

 <p>Yellow Push Button (i2y)</p>	 <p>Logic Module - OR(f2)</p>	 <p>BOSON cable *2</p>
---	--	---

What You Do

1. Modify the circuit according to the figure on the right

Note: Connect the circuit in the direction of the arrow on the logic OR module.

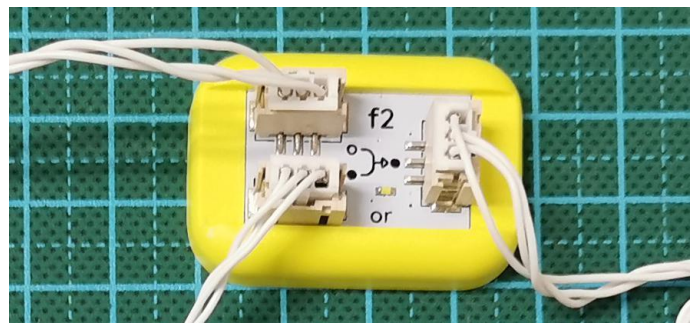
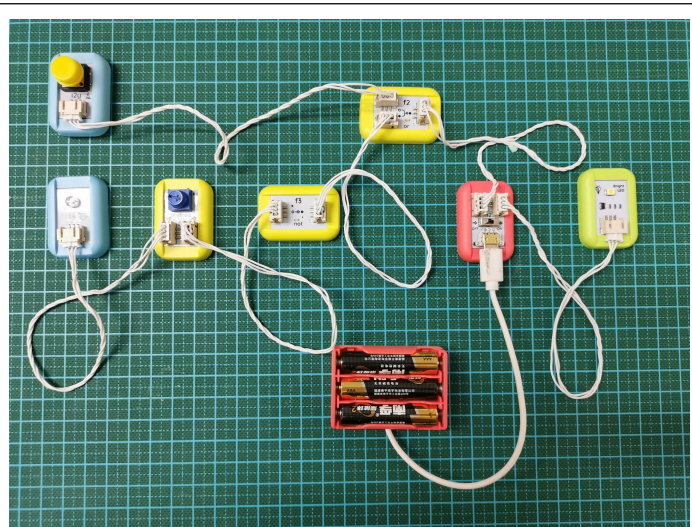

2. Turn the switch of the main control board to ON. Press the button, the LED light turns on, release the button, the LED goes out.

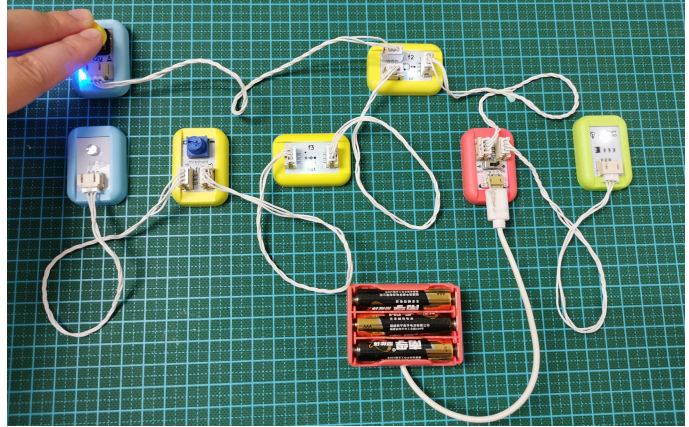

3. Cover the transparent probe of the light sensor with your hand, the LED light turns on, remove your hand, and the LED goes out.

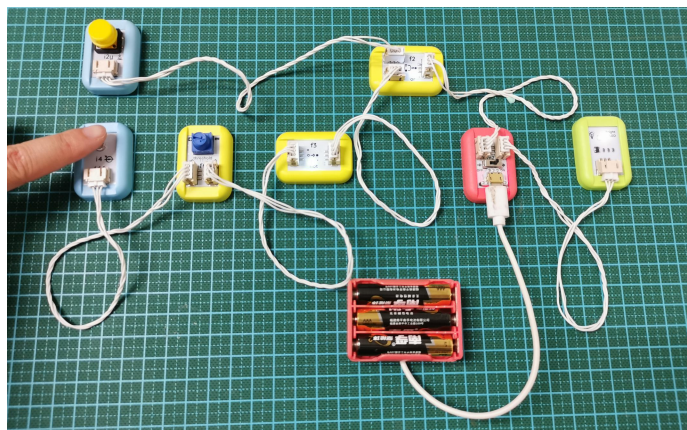

4. Finally, fix all BOSON modules on the Lego bracket to complete the production of the device.



Test and evaluate

The optimized device realizes automatic and manual control at the same time. When the light sensor detects that the natural light becomes weak,

it will automatically turn on the LED light. When we press the button, we can also manually light up the LED light.

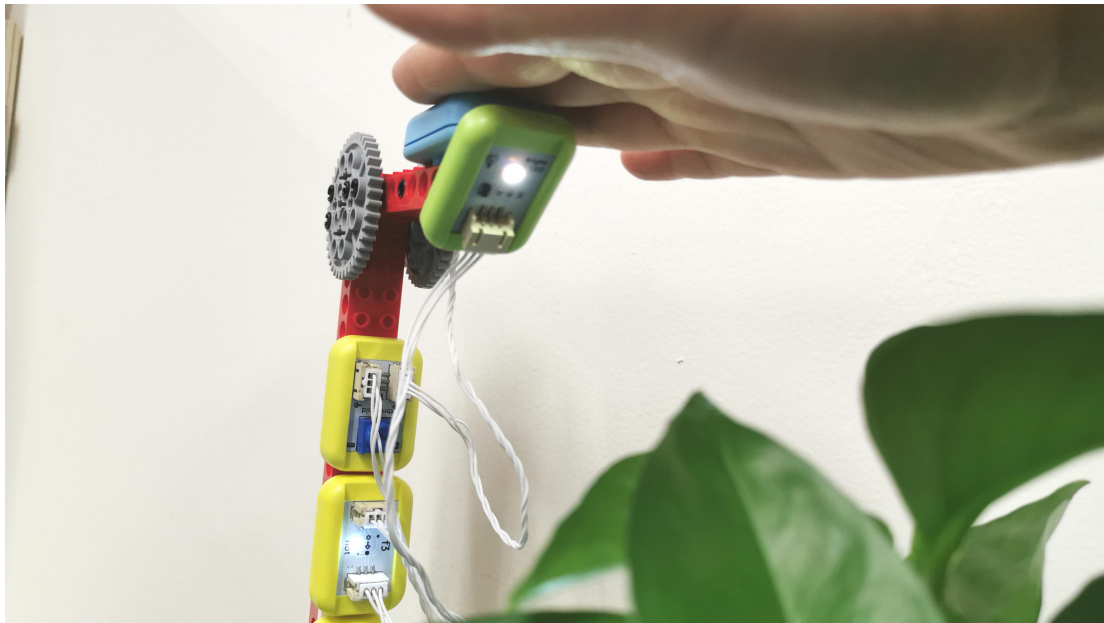

Further Development

In this activity, we made a very simple automatic light-supplying device for plants, and we can also continue to optimize the design of the device. For example, what color of light helps plants grow better? Let's continue to explore it!



Science Background

Why do plants need light?

As the saying goes, "All living things depend on the sun for their growth" . Most of the energy on the earth comes from the sun. Through its photosynthesis, plants can convert solar energy into chemical energy, which is stored in the formed organic compounds.

Photosynthesis refers to the process by which plants absorb energy from sunlight and convert carbon dioxide and water into oxygen and their chemical energy. In photosynthesis, plants first absorb the energy of the sun, and then use this energy to decompose water molecules into hydrogen and oxygen, and finally oxygen is released into the atmosphere. The hydrogen and carbon dioxide combine to form glucose or plant food, which is stored in leaves, roots or fruits.

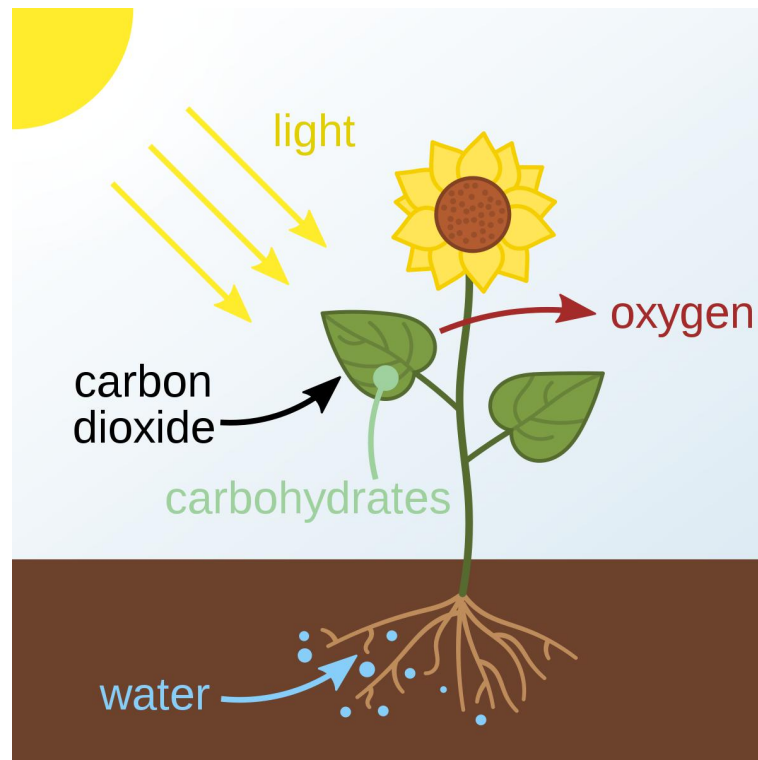

The energy produced through photosynthesis not only meets the needs of plants for their growth, but also provides a source of food for humans and animals. In this way, plants are like a giant energy conversion station, converting solar energy into energy that can be used by humans and animals.

What color of light do plants like?

Green plants have the strongest absorption of red light and blue-purple light and can perform photosynthesis best, so plants prefer red and blue-purple light. This is why the fill-in lamps on the market are generally red light and blue-purple light.



Conclusion

In this project, we made an automatic light-supplying device for plants, and solved the problem of lack of light for plants in winter or rainy days. In the further development, we also mentioned the effect of light color on plant growth. Choosing an appropriate color helps optimize the design of the device.

The project is going to an end, please remove cables, and put all the BOSON modules back into the original positions of the kit.

LESSON 11: Automatic Watering



Introduction

Standards

NGSS

5-LS1-1 Demonstrate that plants get the nutrients they need for growth mainly from water and air.

Science - Grade 3-5

Overview

This lesson will begin with the question “Why towels can absorb water” to lead students to discuss and get to know the capillarity action of water. They will be asked to make an automatic watering device based on the capillarity action principle, and explore how to improve the watering efficiency by enhancing the capillarity or reducing water evaporation.

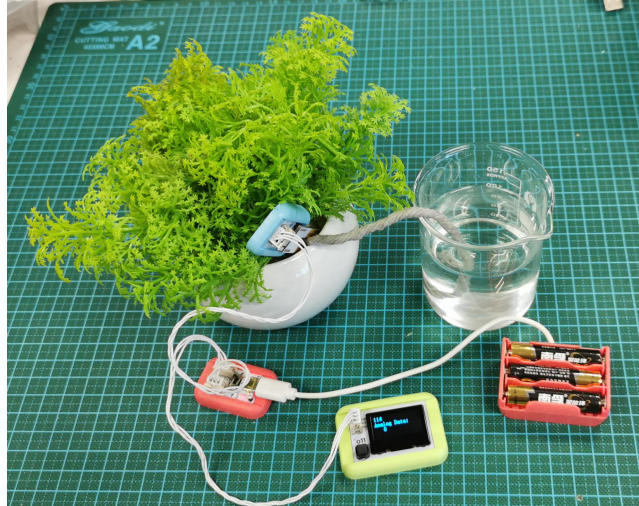

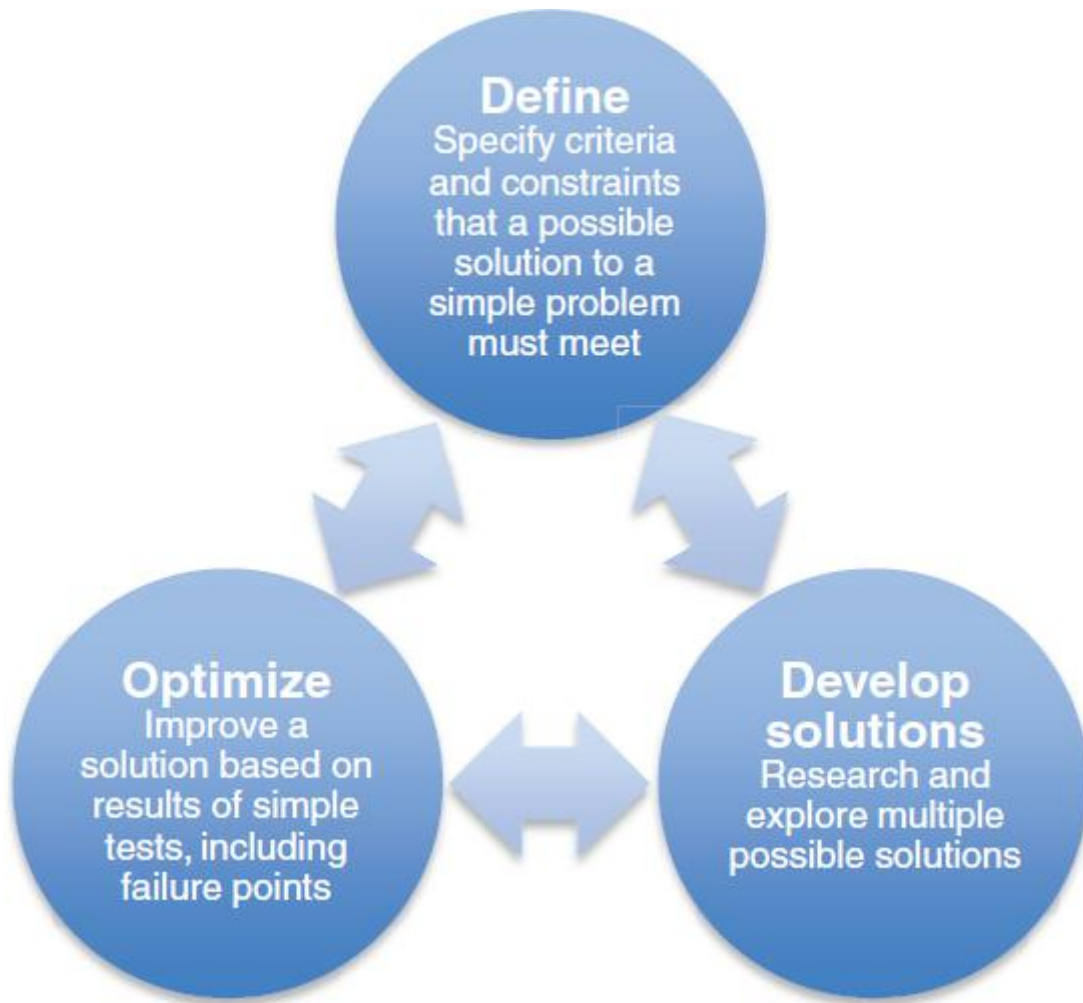

According to the NGSS standard engineering design requirement in 3-5 grades, the course is divided into 3 parts, they are respectively “DEFINE ENGINEERING PROBLEMS, DEVELOPING POSSIBLE SOLUTIONS, OPTIMIZING THE DESIGN SOLUTION” . Just like engineers, students will find problems, set goals, design plans, build and test models, optimize and improve models, and finally complete the engineering design task.



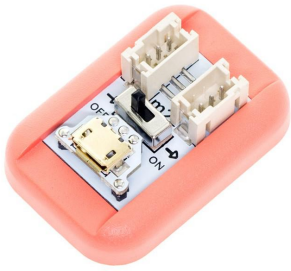

Materials

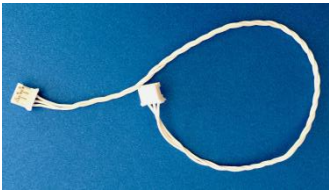
BOSON Module	Image	Function
Battery Holder (3x AAA batteries installed)		4.5V Power Supply

MainBoard-1IO (m2)		Provide power for other modules
Soil Moisture (i16)		Measure the value of soil moisture.
Display Module(o11)		Provide visible effect for users to check experimental results
BOSON cable *2		Cooperate with 3-Pin fool-proofing connector to connect other modules

Additional Materials	Image	Function
----------------------	-------	----------

Potted Plants		The experimental object
Cotton Rope		Used to make the automatic watering device
Breaker and Water		Used to provide water

Activity 1 DEFINE ENGINEERING PROBLEMS

Find Problems

We always grow flowers at home, but when we travel, there is a problem that the flowers will be unattended, and even wither because of lacking water.

Can we design an engineering device to realize the function of automatic watering?



Engineering Goals

Make an automatic watering device.



Activity 2 DEVELOPING POSSIBLE SOLUTIONS

After determining the engineering goals, let us follow the process of “Brainstorming-Drawing Prototype Diagram-What You Need-What You Do-Test and Evaluate” to develop a solution and complete the structure of the automatic watering device.

Brainstorm

Let’ s first brainstorm how to build an automatic watering device. In the process, try to draw a prototype of the automatic watering device.

Question	Reference Answer
1. How to water plants automatically?	We know that towels can absorb water. If you put one end of the towel in the water and the other end in the flower pot, then the plants can be watered

	<p>automatically.</p> 
<p>2. What else can absorb water?</p>	<p>In addition to towels, there are also loose and porous objects such as tissues, sponges, and cotton ropes.</p> 
<p>3. Which one is better to make the automatic watering device? Towel, tissue, sponge, or cotton rope?</p>	<p>Different objects are with different defects. For example, tissues are easy to spoil when exposed to water, towels are too big, and sponges are hard. After comprehensive consideration, we choose cotton rope to make the automatic watering device.</p>
<p>4. Can we observe the efficiency of watering?</p>	<p>Add BOSON soil moisture sensor to observe the efficiency of watering by detecting changes in soil moisture.</p>

Draw Prototype Diagram

In the brainstorming, we have initially understood the function and structure of the automatic watering device. Try drawing a prototype diagram. In the production process, the prototype diagram will be an important reference.

What You Need

A green plastic case containing a small LCD display and a microcontroller board with a single pin header.	An orange plastic case containing a microcontroller board with multiple pin headers and a small yellow component.	A blue plastic case containing a microcontroller board with two yellow probes attached to the bottom.
Display Module(o11)	MainBoard-1IO (m2)	Soil Moisture (i16)
An orange plastic battery holder with three AAA batteries inserted and a white USB-A to micro-USB cable attached.		A white cable with a micro-USB connector on one end and a different connector on the other, set against a blue background.
Battery Holder (3x AAA batteries installed)	BOSON cable *2	
A 3D illustration of a green leafy plant in a grey geometric pot.	A coil of thick, white, braided cotton rope.	A glass beaker containing water and a small white electronic component, sitting on a green grid mat.
Potted Plants	Cotton Rope	Breaker and Water

What You Do

1. Prepare BOSON modules.
According to the picture on the right, build an experimental circuit to realize the function of measuring the soil moisture.

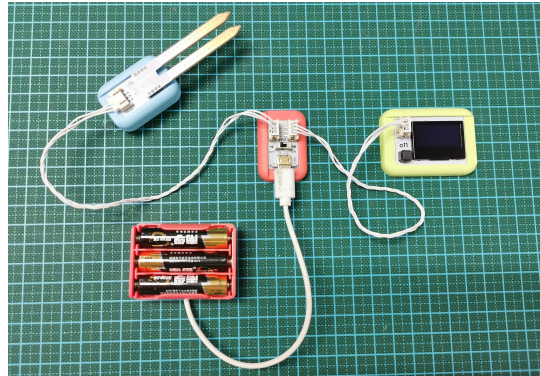

2. Prepare a potted plant and a cotton rope, and insert one end of the cotton rope into the soil of the potted plant.

3. Prepare a breaker of water and put the other end of the cotton rope into the water.

4. Insert the soil moisture sensor into the soil near the cotton rope, observe the change of soil moisture on the display screen, and record it in the table below.

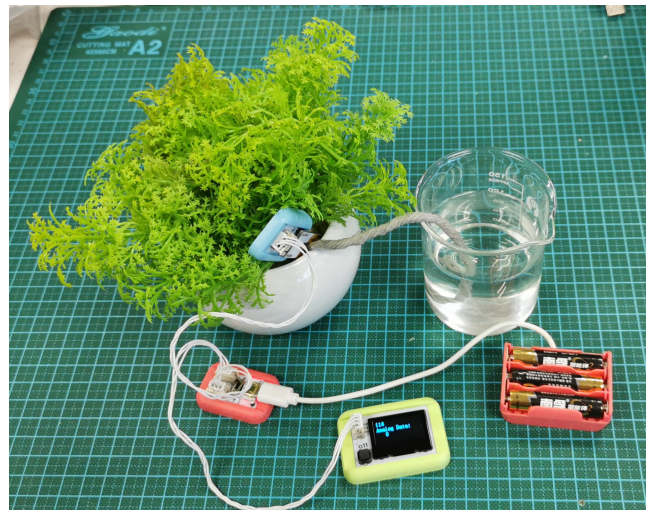

Soil moisture change table:

Time	1min	4min	7min	10min
Moisture				

Test and evaluate

Through the above steps, a simple automatic watering device is completed! When we touch the cotton rope with our hands, we will find that the cotton rope becomes wet, because it sucks up the water in the breaker, and the water will follow it to the soil, which realizes the automatic watering function.

Observe and compare the changes in soil moisture. Is the efficiency of the watering device of each group of students the same? Think about it, do you think there is still room for improving the device? How to improve the efficiency of watering? Try proposing an optimization plan to improve the watering efficiency.

Activity 3 OPTIMIZING THE DESIGN SOLUTION

Brainstorm

Question	Reference Answer
1. How to water plants faster?	We know that one cotton rope can water the plants with a small amount of water. If you use many ropes to water the plants at the

	same time, or use a very thick one, you can speed up the watering.
2. Is there still room for improving the automatic watering device?	Water is easy to evaporate. When the damp cotton rope is exposed to the air, the amount of evaporation is very large. We can find ways to reduce evaporation. For example, put the cotton rope in straw to reduce the contact between the rope and the air, so that the evaporation of water can be reduced.

What You Do

Based on the brainstorm, select an optimization plan.

Use BOSON soil moisture sensor to observe the changes of soil moisture and record them in the table below.

Optimized soil moisture change table:

Time	1min	4min	7min	10min
Moisture				

Test and evaluate

Draw the table of activity 1 and activity 2 onto one line chart and observe whether the watering efficiency is improved.

What happened?

As we said before, the soil can hold water because there are many small pores, which form the capillarity. The capillarity allows water to overcome its gravity and adhere to the small pores.

Cotton rope can absorb water for the same reason. Observing the cross-section of the rope, it can be seen that it is very loose and porous. There are also many small pores in the cotton rope. When the cotton rope encounters water, the capillarity will cause the water to overcome its gravity and climb up the cotton rope to fill these small pores. We know that water always flows from a higher place to a lower one, but through the capillarity, "water goes to a high place" is realized.

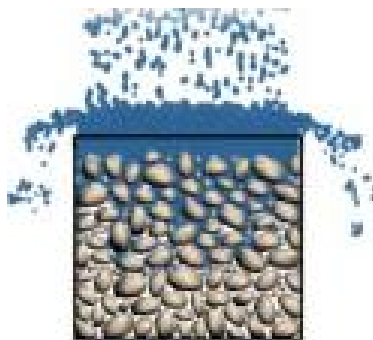

Further Development

In this activity, we made a very simple automatic watering device, and we can also try adjusting many variables in the design to make it better. For example, we can also change the watering efficiency by changing the thickness or quantity of the rope, or use a straw to cover the rope to reduce the evaporation of water. Students who are interested can give it a try!

Besides, some plants like water, while some don't, such as cacti. When using an automatic watering device in practice, it is recommended to learn whether the plants like water first!

Science Background

What is capillarity?

We know that because the soil and cotton rope are both loose and porous, the capillarity produced in the small pores allows the water to overcome its gravity and adhere to the pores. Capillarity can be understood as the attraction of small pores to liquid. Capillarity allows liquid to flow in narrow pores even under the action of gravity. The smaller the pores, the stronger the capillary action. When the pores become larger, the capillarity will become weaker due to the influence of gravity.

In life, capillarity exists everywhere, such as absorbent towels, candle

wicks, alcohol wicks, etc. In addition, plants cannot absorb water without capillarity. In plants, there are many tiny vessels. After the roots of plants absorb water in the soil, capillarity allows the water to flow along the small vessels of the plant to all branches and leaves. It can be said that without capillarity, trees cannot flourish.

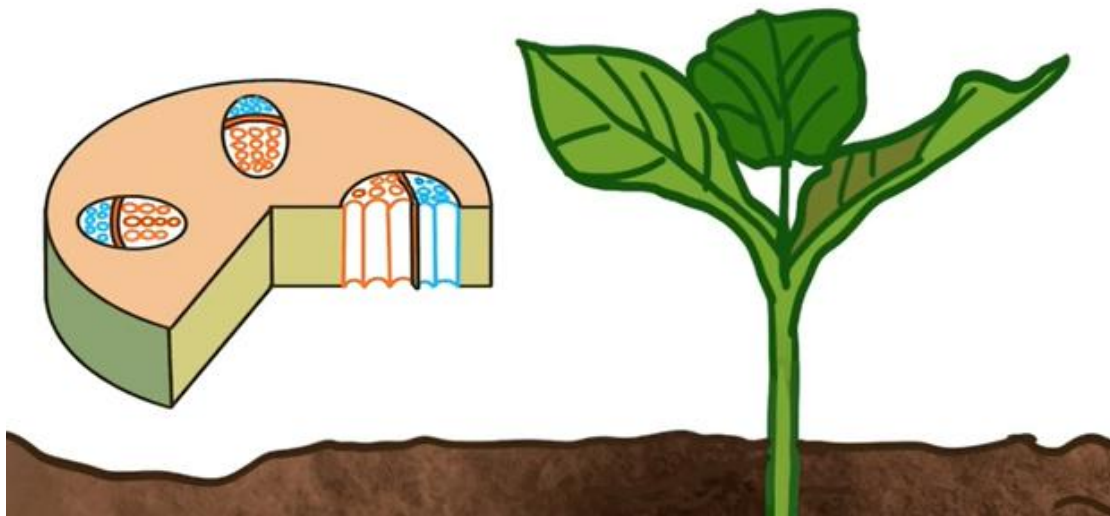

We can also observe the capillarity of plants through a simple experiment. Put the bottom of the celery stalk in a glass of water with food coloring and observe the movement of the color to the top leaves of the celery. It may take a few days. As shown in the picture below, even with the effect of gravity, colored water is still "attracted" upwards. The reason is that the capillarity of the small vessels in plants allows water molecules to move upwards.



Conclusion

In this project, we made an automatic watering device based on the capillarity of cotton rope. In further exploration, we also mentioned how to improve the efficiency of the automatic watering device by the enhancement of capillarity or the reduction of water evaporation.

The project is going to an end, please remove cables, and put all the BOSON modules back into the original positions of the kit.

LESSON 12: Burglar Alarm



Introduction

Standards

NGSS

5-PS1-3 Make observations and measurements to identify materials based on their properties.

Science - Grade 3-5

Overview

Taking "Burglar Alarm" as an open subject, the last project in this set of lessons guides students to complete engineering design tasks according to the NGSS standard steps. Just like engineers, students will find problems, set goals, design plans, build and test models, optimize and improve models, and finally complete the whole project.

Materials

All the BOSON modules in the kit.

Activity 1 DEFINE ENGINEERING PROBLEMS

Find Problems

When sleeping at night, we may worry that thieves may come into the house and steal our valuables. Think about it, can we make a burglar alarm based on the engineering design method we learned before? When the thief steals valuables, the burglar alarm will make a sound!

Engineering Goals

Make a burglar alarm.

Activity 2 DEVELOPING POSSIBLE SOLUTIONS

After determining the engineering goals, let us follow the process of “Brainstorming-Drawing Prototype Diagram-What You Need-What You Do-Test and Evaluate” to develop a solution and complete the building of the burglar alarm.

Brainstorm

Let’s first brainstorm how to build a burglar alarm. In the process, try drawing a prototype for it.

If you don't have ideas for this project, you might as well look for the project inspiration in the appendix!

Question	Reference Answer
1. What is the function of the burglar alarm?	
2. How can we make a burglar alarm?	
3. Which BOSON modules are needed?	
4. What other materials are needed?	

Draw Prototype Diagram

In the brainstorming, we have initially understood the function and structure of the burglar alarm. Try drawing a prototype diagram. In the production process, it will be an important reference.



What You Need

List the materials you need in the table below.

What You Do

Record your steps in the table below.

Step 1	
Step 2	
Step 3	
Step 4	
Step 5	

Test and Evaluate

Do you think the burglar alarm can be optimized? Try proposing an optimization plan to improve the efficiency of the burglar alarm.

Conclusion

In this project, we set up an open subject so everyone can make their burglar alarm.

The project is going to an end, please remove cables and put all the BOSON modules back into the kit according to the corresponding position.

Appendix-Reference Project

Burglar alarm based on button and buzzer

Place valuables on the button to keep it pressed. When the thief removes the item, the button will be released and the buzzer will make a sound.

Burglar alarm based on button and fan

Change the buzzer in the previous project to a fan to make an alarm sound. For example, fix small iron nails on the tip of the fan blade and place a can next to it. When the fan rotates, they will hit the can to make an alarm sound.

Burglar alarm based on buzzer and light sensor

Lock valuables in a closed and dark box. When the thief opens the box, the light sensor senses that the light becomes stronger, which can trigger the buzzer.