

PCB Information	Name:[DFRID73](V1.0.0)	Thickness: 1.6mm
Engineer:Aaron	Top SolderMask: Black	Bottom SolderMask: Black
Date: 20230713	Top Silkscreen: White	Bottom Silkscreen: White

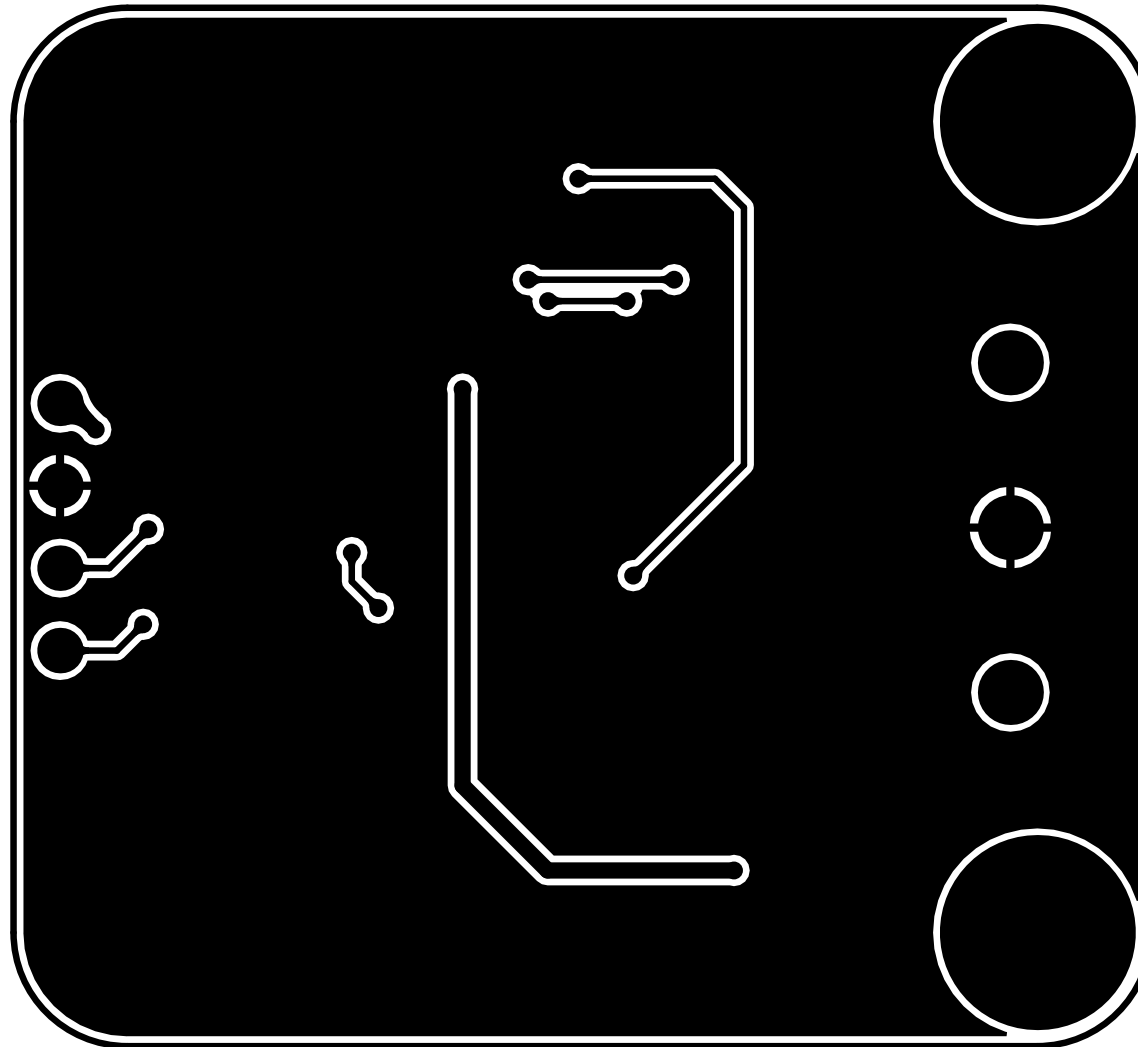

PCB Information	Name:[DFR1073](V1.0.0)	Thickness: 1.6mm
Engineer:Aaron	Top SolderMask: Black	Bottom SolderMask: Black
Date: 20230713	Top Silkscreen: White	Bottom Silkscreen: White

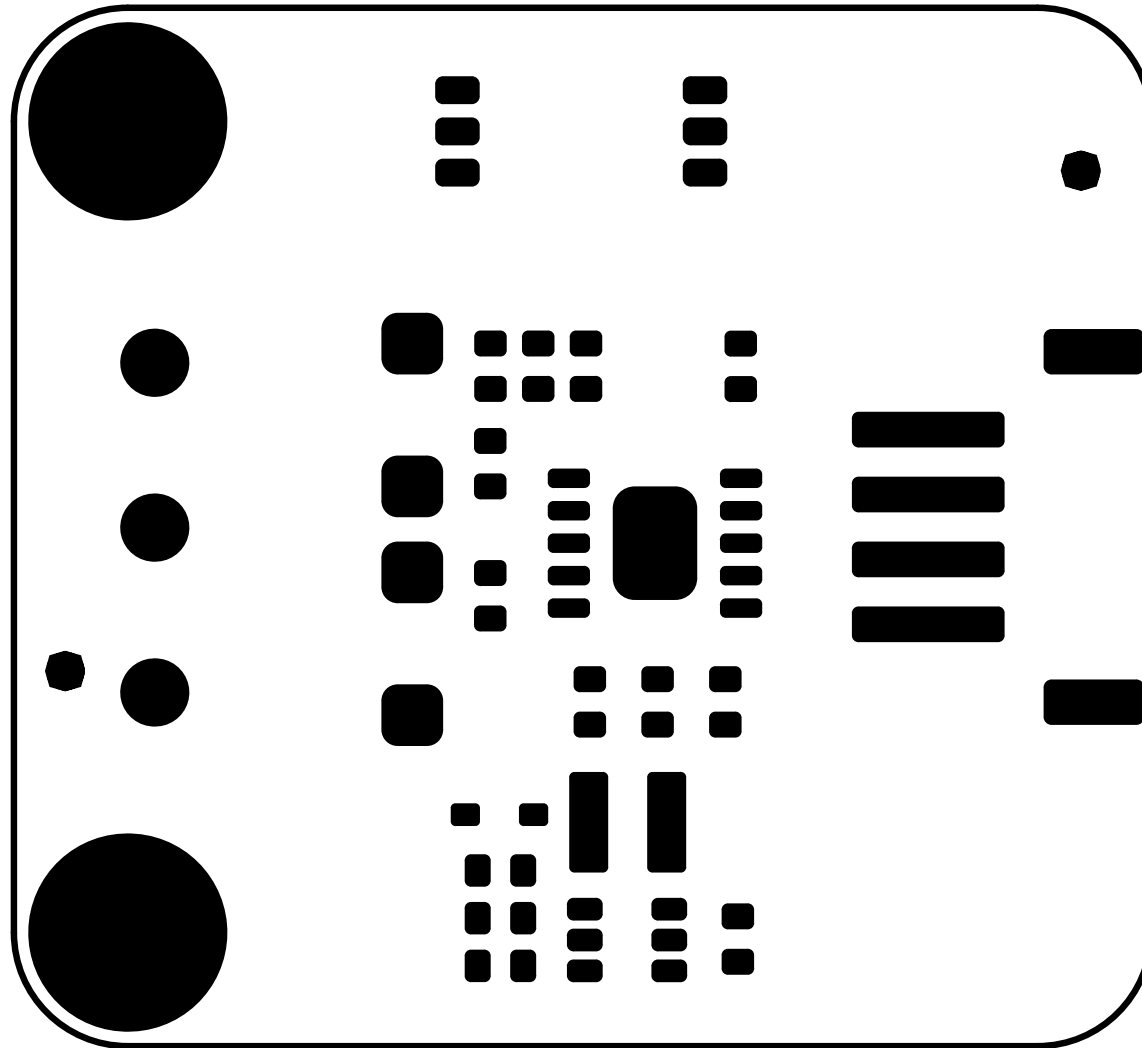

PCB Information	Name:[DFRID73](V1.0.0)	Thickness: 1.6mm
Engineer:Aaron	Top SolderMask: Black	Bottom SolderMask: Black
Date: 20230713	Top Silkscreen: White	Bottom Silkscreen: White

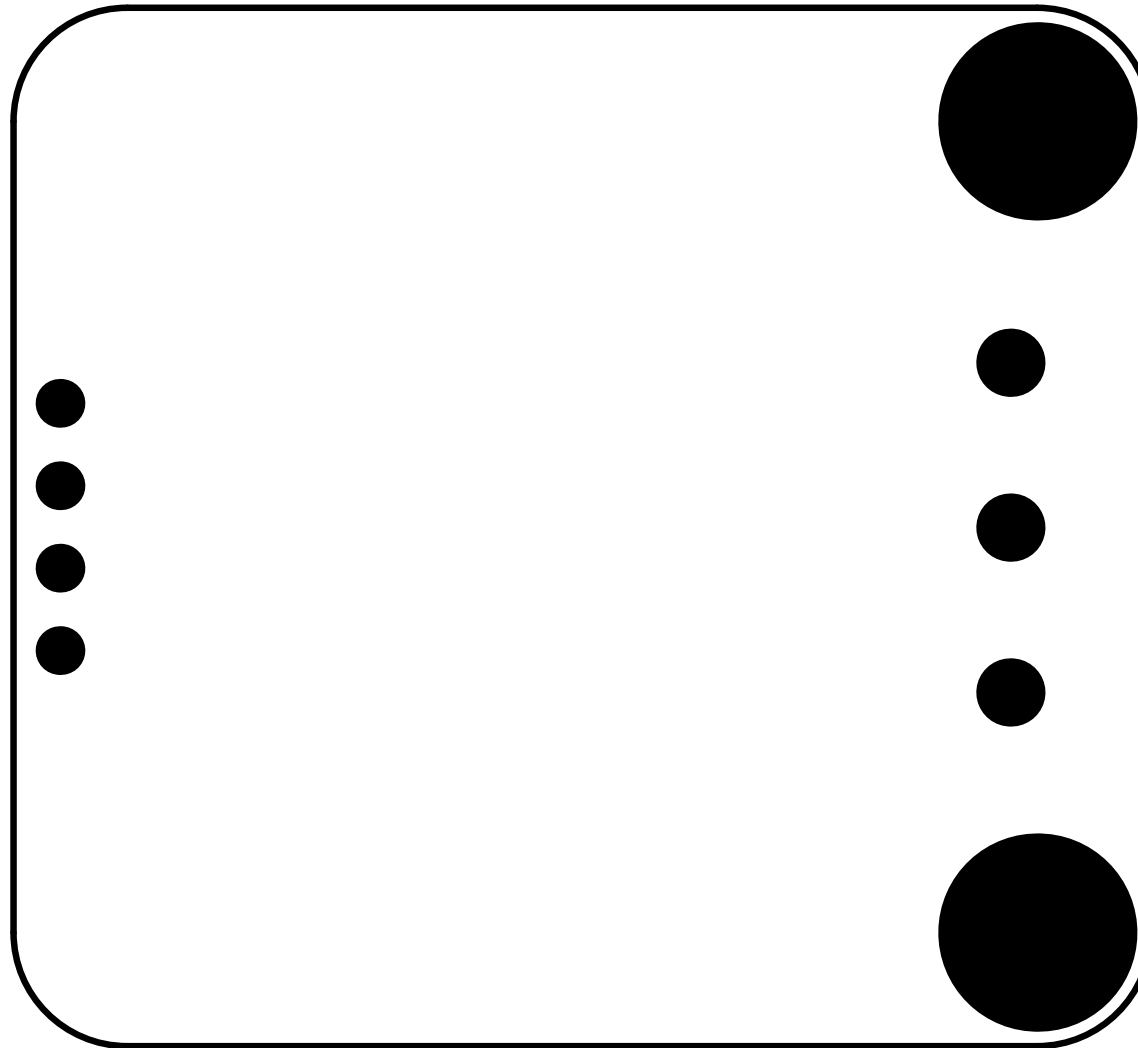

PCB Information	Name:[DFR1073](V1.0.0)	Thickness: 1.6mm
Engineer:Aaron	Top SolderMask: Black	Bottom SolderMask: Black
Date: 20230713	Top Silkscreen: White	Bottom Silkscreen: White

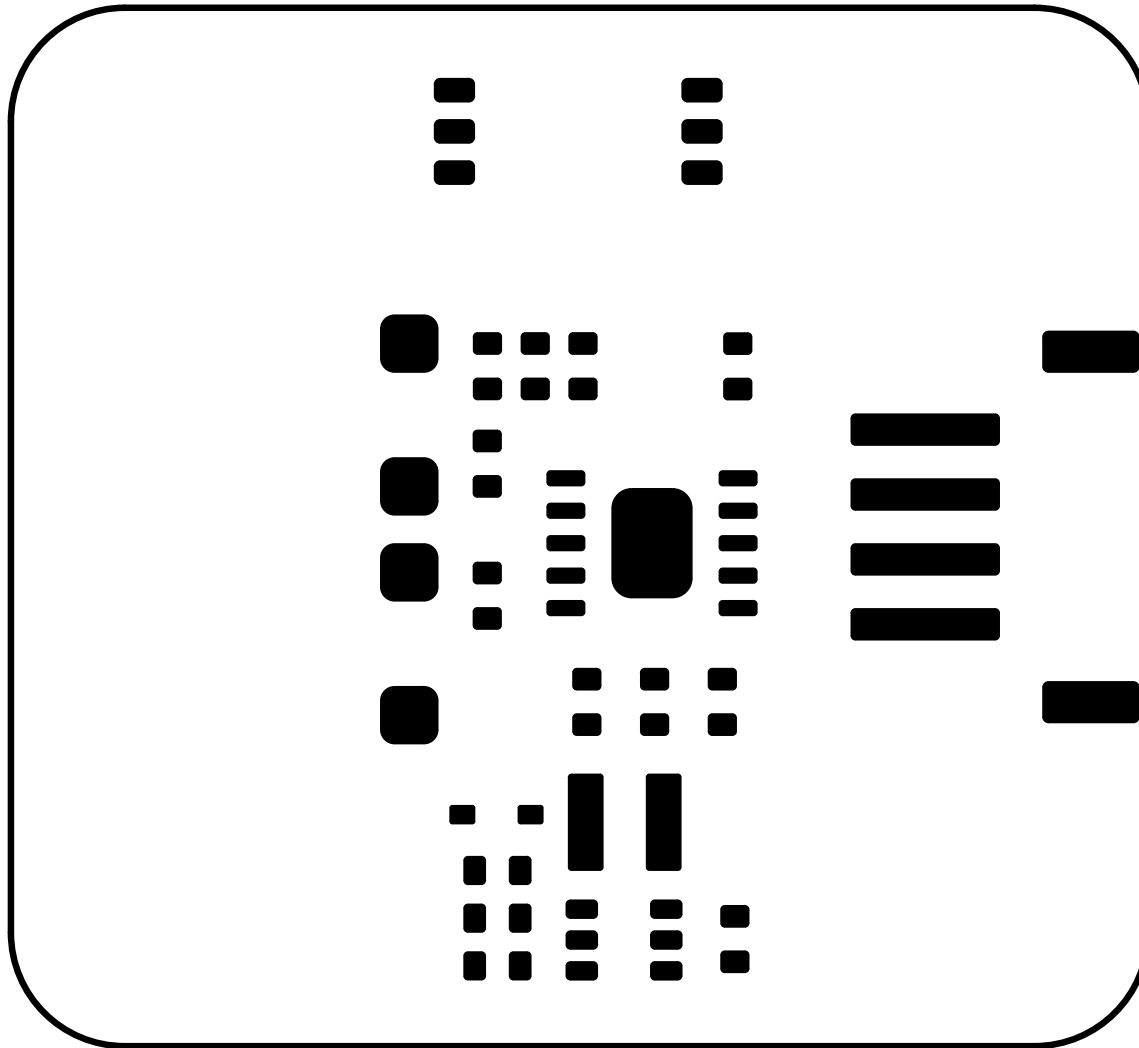

PCB Information	Name:[DFRID73](V1.0.0)	Thickness: 1.6mm
Engineer:Aaron	Top SolderMask: Black	Bottom SolderMask: Black
Date: 20230713	Top Silkscreen: White	Bottom Silkscreen: White

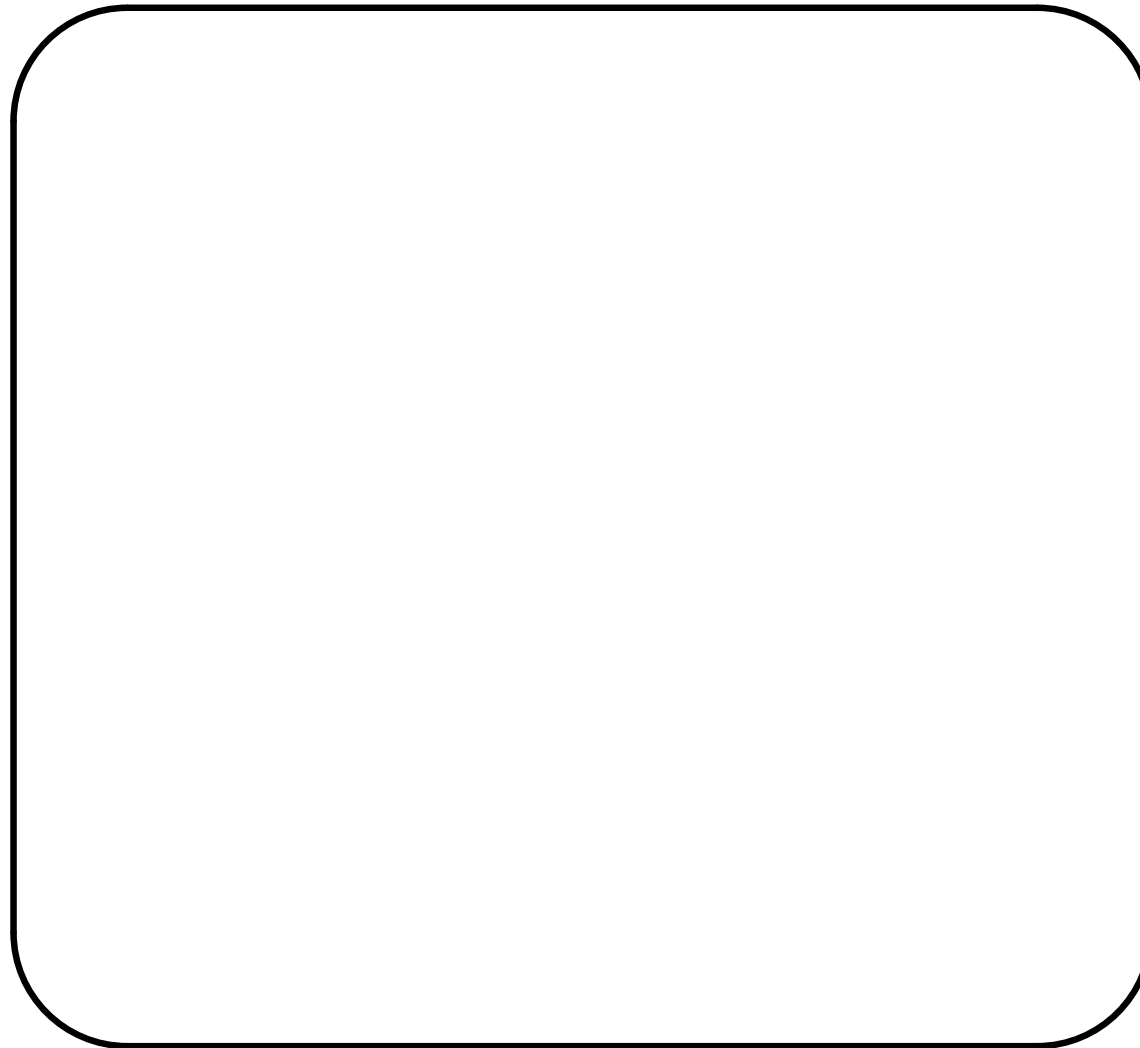

PCB Information	Name:[DFR1073](V1.0.0)	Thickness: 1.6mm
Engineer:Aaron	Top SolderMask: Black	Bottom SolderMask: Black
Date: 20230713	Top Silkscreen: White	Bottom Silkscreen: White

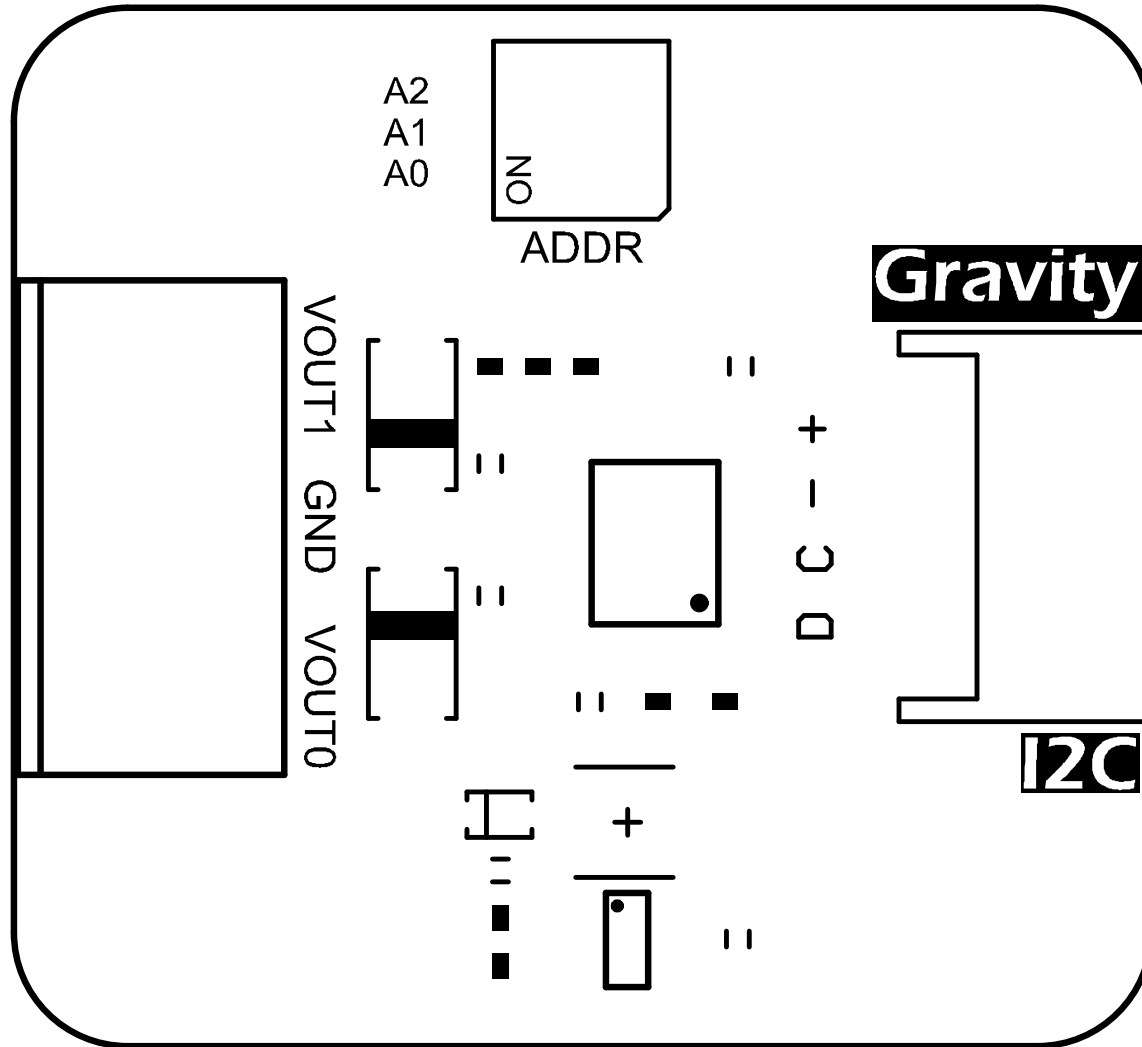

PCB Information	Name:[DFRID73](V1.0.0)	Thickness: 1.6mm
Engineer:Aaron	Top SolderMask: Black	Bottom SolderMask: Black
Date: 20230713	Top Silkscreen: White	Bottom Silkscreen: White



DFROBOT

GP8413: I2C to 0-5V/10V x2 (15bit)
V1.0

100

PCB Information	Name:[DFR1073](V1.0.0)	Thickness: 1.6mm
Engineer:Aaron	Top SolderMask: Black	Bottom SolderMask: Black
Date: 20230713	Top Silkscreen: White	Bottom Silkscreen: White

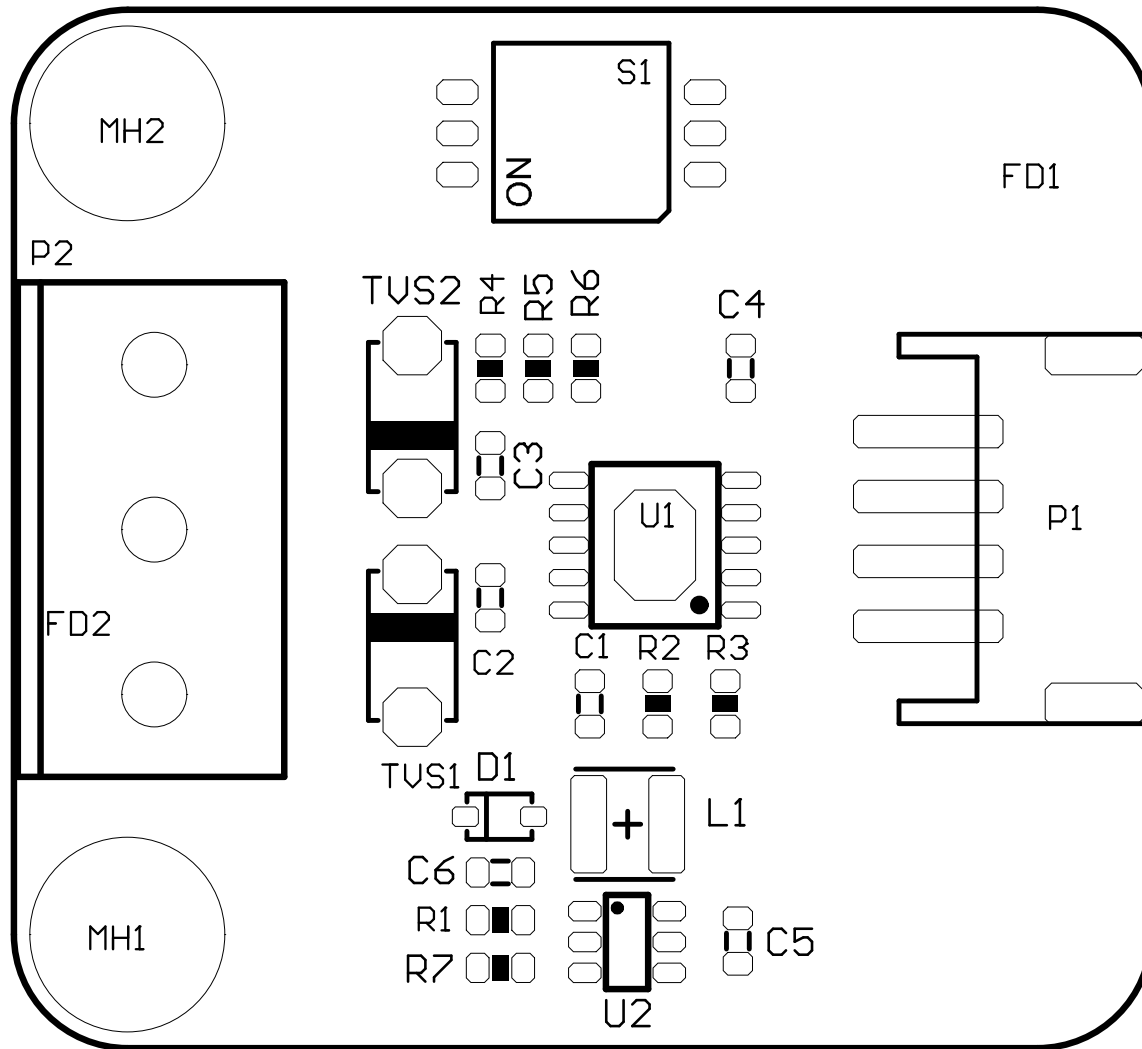

PCB Information	Name:[DFRID73](V1.0.0)	Thickness: 1.6mm
Engineer:Aaron	Top SolderMask: Black	Bottom SolderMask: Black
Date: 20230713	Top Silkscreen: White	Bottom Silkscreen: White

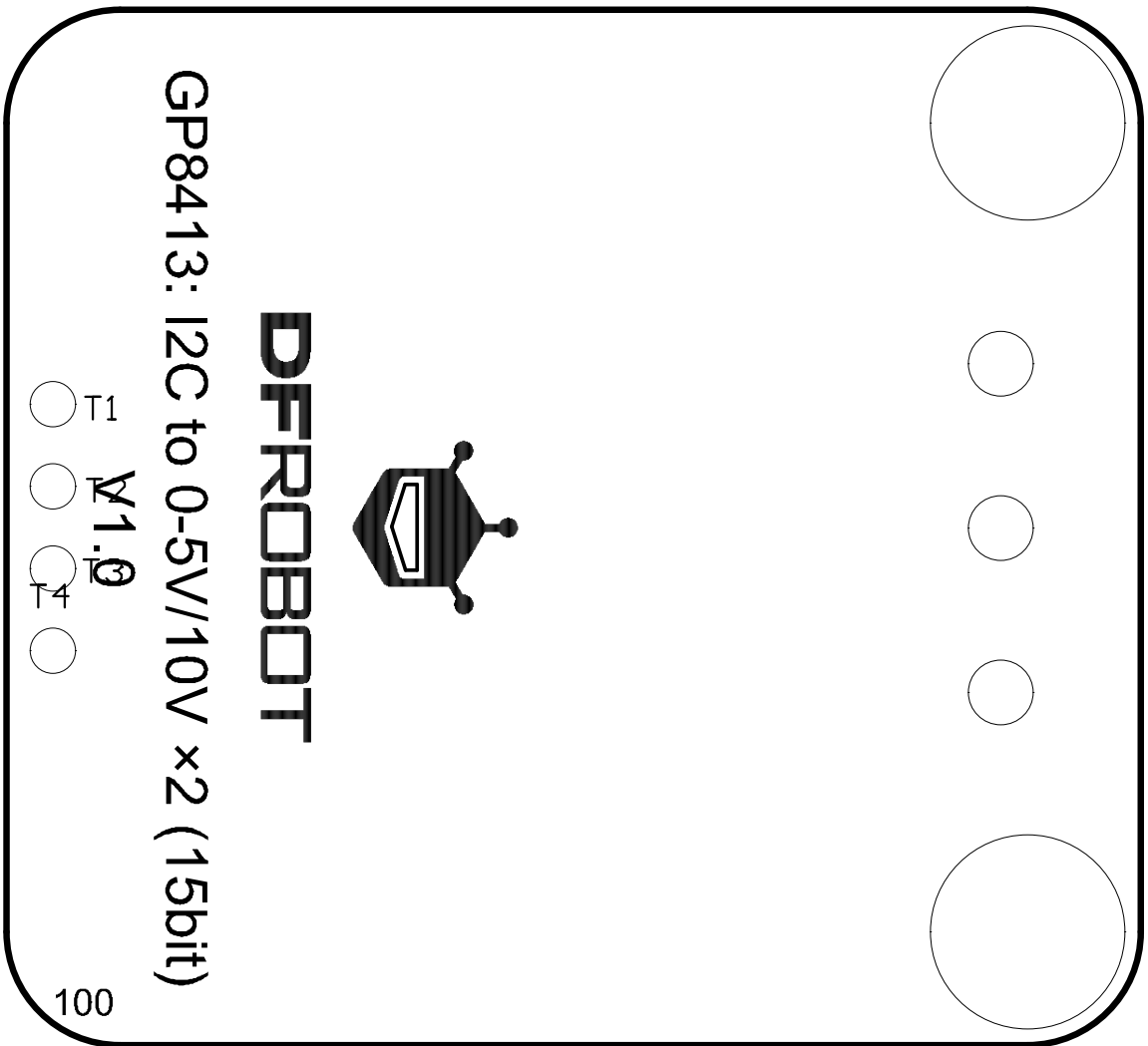

PCB Information	Name:[DFR1073](V1.0.0)	Thickness: 1.6mm
Engineer:Aaron	Top SolderMask: Black	Bottom SolderMask: Black
Date: 20230713	Top Silkscreen: White	Bottom Silkscreen: White

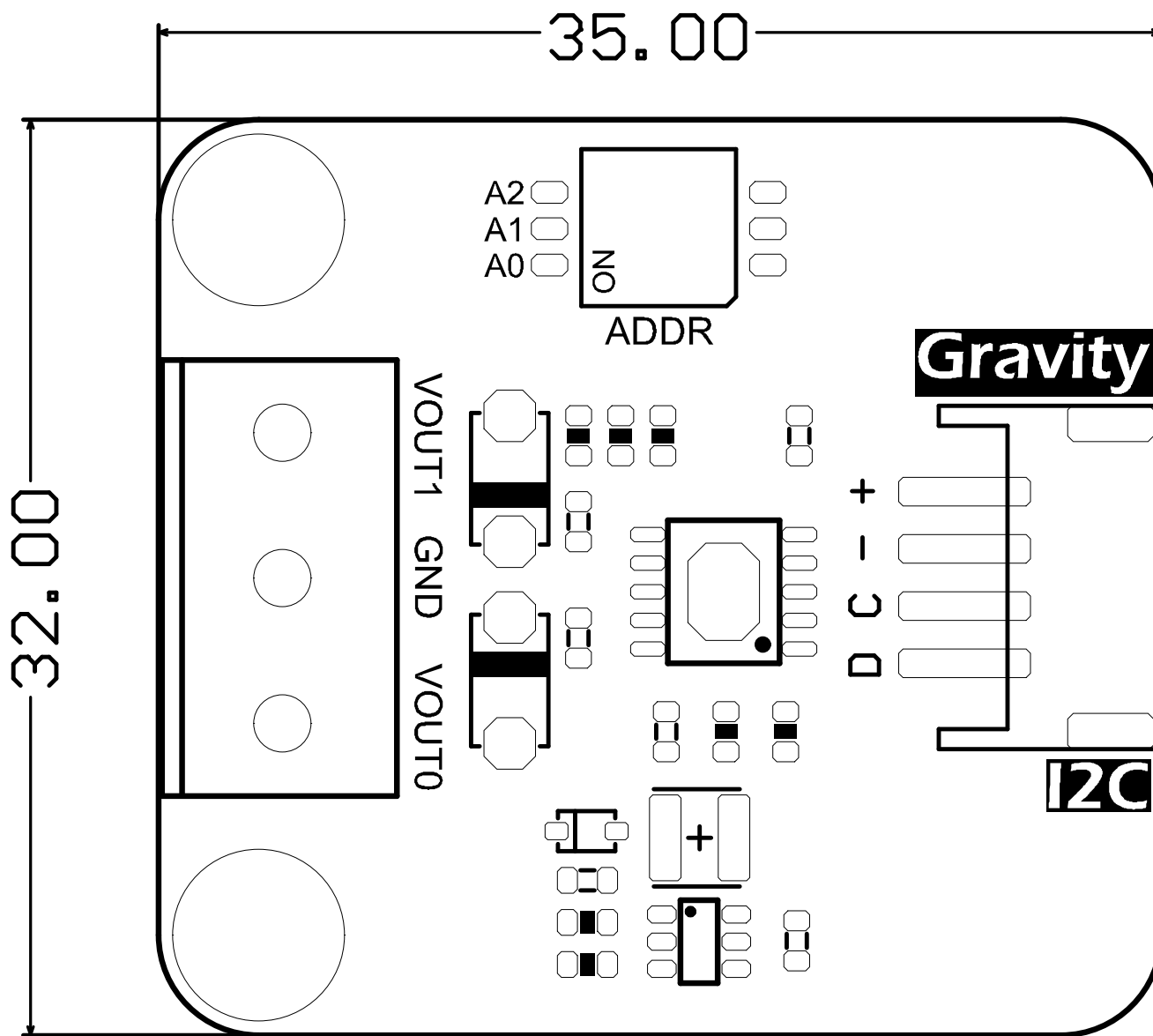

PCB Information	Name:[DFR1073](V1.0.0)	Thickness: 1.6mm
Engineer:Aaron	Top SolderMask: Black	Bottom SolderMask: Black
Date: 20230713	Top Silkscreen: White	Bottom Silkscreen: White

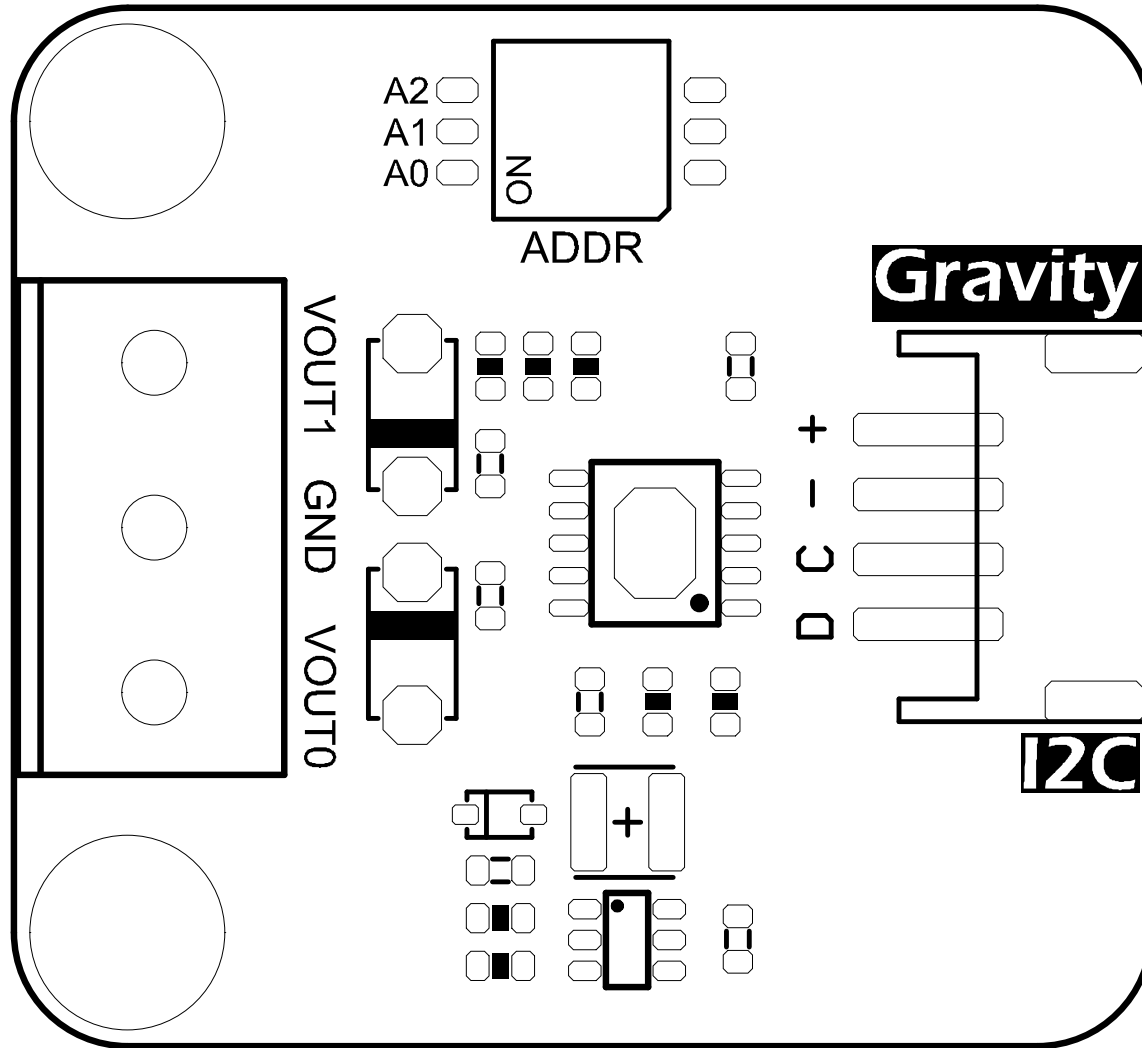

PCB Information	Name:[DFR1073](V1.0.0)	Thickness: 1.6mm
Engineer:Aaron	Top SolderMask: Black	Bottom SolderMask: Black
Date: 20230713	Top Silkscreen: White	Bottom Silkscreen: White

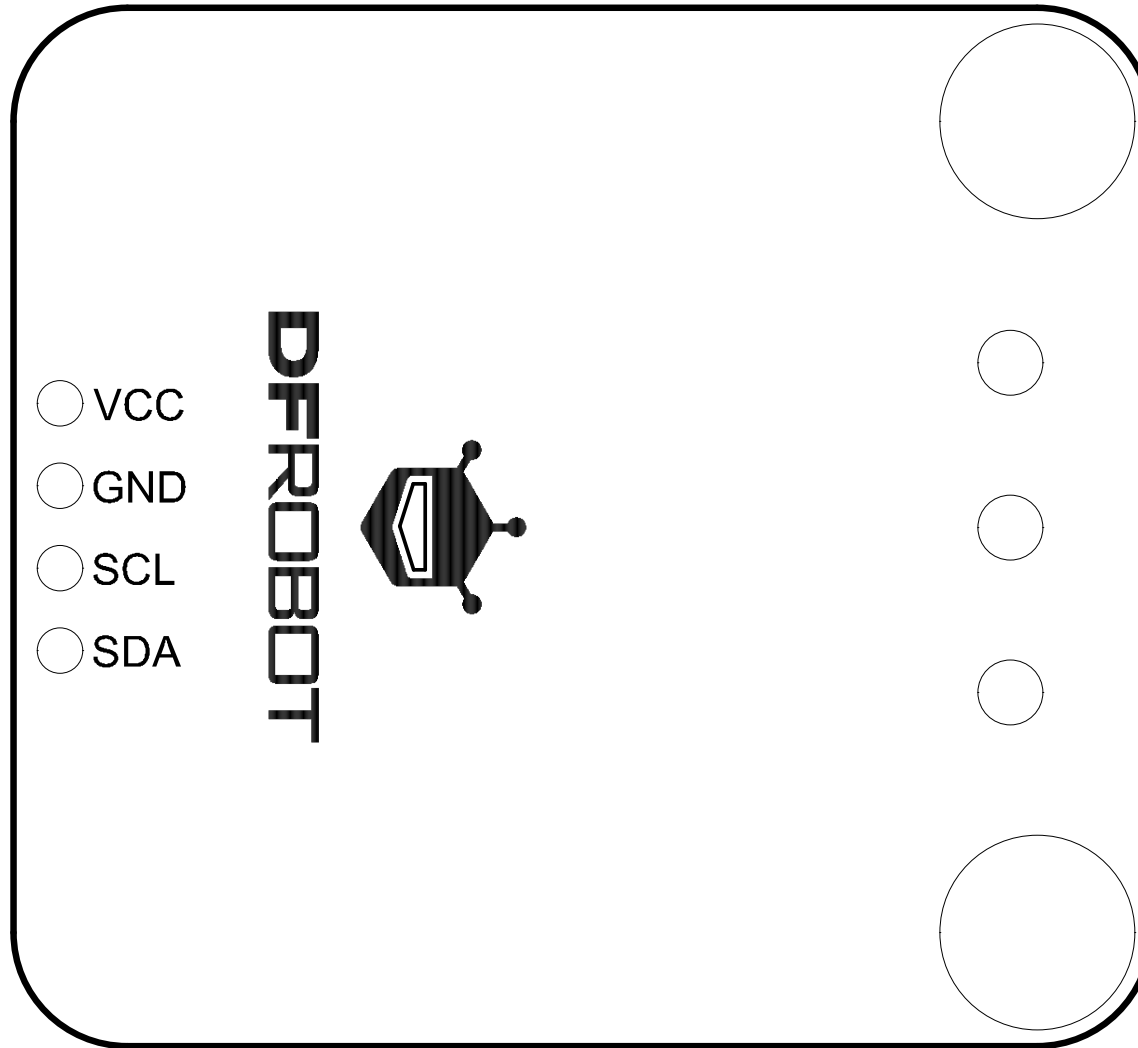

PCB Information	Name:[DFR1073](V1.0.0)	Thickness: 1.6mm
Engineer:Aaron	Top SolderMask: Black	Bottom SolderMask: Black
Date: 20230713	Top Silkscreen: White	Bottom Silkscreen: White