



## Table of Contents

Basic Troubleshooting	1	DOs and DON'Ts of Building Circuits	7
Parts List	2	Advanced Troubleshooting	8
How to Use It	3	Project Listings	9
About Your Snap Circuits® Parts	4 - 5	Projects 1 - 133	10 - 51
Introduction to Electricity	6	Snap Circuits® Project Shapes	52

 **WARNING FOR ALL PROJECTS WITH A  SYMBOL** - Moving parts. Do not touch the motor or fan during operation. Do not lean over the motor. Do not launch the fan at people, animals, or objects. Eye protection is recommended. 

 **WARNING: SHOCK HAZARD** - Never connect Snap Circuits® to the electrical outlets in your home in any way!

 **WARNING: CHOKING HAZARD** - Small parts. Not for children under 3 years.

Conforms to all applicable U.S. government requirements and CAN ICES-3 (B)/NMB-3 (B).

## Basic Troubleshooting

1. Most circuit problems are due to incorrect assembly, always double-check that your circuit exactly matches the drawing for it.
2. Be sure that parts with positive/negative markings are positioned as per the drawing.
3. Be sure that all connections are securely snapped.
4. Try replacing the batteries.

Elenco® is not responsible for parts damaged due to incorrect wiring.

**Note:** If you suspect you have damaged parts, you can follow the Advanced Troubleshooting procedure on page 8 to determine which ones need replacing.

**WARNING:** Always check your wiring before turning on a circuit. Never leave a circuit unattended while the batteries are installed. Never connect additional batteries or any other power sources to your circuits. Discard any cracked or broken parts.

**Adult Supervision:** Because children's abilities vary so much, even with age groups, adults should exercise discretion as to which experiments are suitable and safe (the instructions should enable supervising adults to

establish the experiment's suitability for the child). Make sure your child reads and follows all of the relevant instructions and safety procedures, and keeps them at hand for reference.

This product is intended for use by adults and children who have attained sufficient maturity to read and follow directions and warnings.

Never modify your parts, as doing so may disable important safety features in them, and could put your child at risk of injury.



### Batteries:





















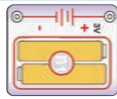

- Use only 1.5V AA type, alkaline batteries (not included).
- Insert batteries with correct polarity.
- Non-rechargeable batteries should not be recharged. Rechargeable batteries should only be charged under adult supervision, and should not be recharged while in the product.
- Do not mix old and new batteries.

- Do not connect batteries or battery holders in parallel.
- Do not mix alkaline, standard (carbon-zinc), or rechargeable (nickel-cadmium) batteries.
- Remove batteries when they are used up.
- Do not short circuit the battery terminals.
- Never throw batteries in a fire or attempt to open its outer casing.
- Batteries are harmful if swallowed, so keep away from small children.

## Parts List (Colors and styles may vary) Symbols and Numbers

**Important:** If any parts are missing or damaged, **DO NOT RETURN TO RETAILER.** Call toll-free (800) 533-2441 or e-mail us at: help@elenco.com. Customer Service • 150 Carpenter Ave. • Wheeling, IL 60090 U.S.A.

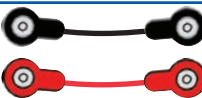
You may order additional / replacement parts at our website: [www.snapcircuits.net](http://www.snapcircuits.net)

Qty.	ID	Name	Symbol	Part #	Qty.	ID	Name	Symbol	Part #
☐ 3	①	1-Snap Wire		6SC01	☐ 1	(L1)	2.5V Lamp		6SCL1
☐ 5	②	2-Snap Wire		6SC02	☐ 1	(M1)	Motor		6SCM1
☐ 3	③	3-Snap Wire		6SC03	☐ 1		Glow Fan		6SCM1FG
☐ 1	④	4-Snap Wire		6SC04	☐ 1	(Q4)	Phototransistor		6SCQ4
☐ 1	⑤	5-Snap Wire		6SC05	☐ 1	(R1)	100Ω Resistor		6SCR1
☐ 1	(B1)	Battery Holder - uses 2 1.5V type AA (not included)		6SCB1	☐ 1	(S1)	Slide Switch		6SCS1
☐ 1		Base Grid (11.0" x 7.7")		6SCBG	☐ 1	(S2)	Press Switch		6SCS2
☐ 1	(D8)	Color LED		SCD8	☐ 1 ☐ 1	(SP2)	Speaker		6SCSP2
☐ 1		Egg LED Attachment		6SCEGG	☐ 1	(U1)	Music Integrated Circuit		6SCU1
☐ 1		Prismatic film		6SCFILM	☐ 1	(U2)	Alarm Integrated Circuit		6SCU2
☐ 1 ☐ 1		Jumper Wire (Black) Jumper Wire (Red)		6SCJ1 6SCJ2	☐ 1	(U3)	Space War Integrated Circuit		6SCU3

# How to Use Snap Circuits®

Snap Circuits® uses building blocks with snaps to build the different electrical and electronic circuits in the projects. Each block has a function: there are switch blocks, light blocks, battery blocks, different length wire blocks, etc. These blocks are different colors and have numbers on them so that you can easily identify them. The blocks you will be using are shown as color symbols with level numbers next to them, allowing you to easily snap them together to form a circuit.

## For Example:

This is the switch block which is green and has the marking **S2** on it. The part symbols in this booklet may not exactly match the appearance of the actual parts, but will clearly identify them.



This is a wire block which is blue and comes in different wire lengths.

This one has the number **2**, **3**, **4**, or **5** on it depending on the length of the wire connection required.



There is also a 1-snap wire that is used as a spacer or for interconnection between different layers.



You need a power source to build each circuit. This is labeled **B1** and requires two (2) 1.5V "AA" batteries (not included).



A large clear plastic base grid is included with this kit to help keep the circuit blocks properly spaced. You will see evenly spaced posts that the different blocks snap into. The base has rows labeled A-G and columns labeled 1-10.

Next to each part in every circuit drawing is a small number in black. This tells you which level the component is placed at. Place all parts on level 1 first, then all of the parts on level 3, etc.

Some circuits use the jumper wires to make unusual connections. Just clip them to the metal snaps or as indicated.



Usually when the motor **M1** is used, the glow fan will usually be placed on it. On top of the motor shaft is a black plastic piece (the motor top) with three little tabs. Lay the fan on the black piece so the slots in its bottom "fall into place" around the three tabs in the motor top. If not placed properly, the fan will fall off when the motor starts to spin.



This set contains an egg LED attachment, which can be mounted on the color LED (D8) to enhance its light effects.



Egg

Egg LED attachment mounted to D8

**Note:** While building the projects, be careful not to accidentally make a direct connection across the battery holder (a "short circuit"), as this may damage and/or quickly drain the batteries.

# About Your Snap Circuits® Parts

(Part designs are subject to change without notice).

## BASE GRID

The **base grid** is a platform for mounting parts and wires. It functions like the printed circuit boards used in most electronic products, or like how the walls are used for mounting the electrical wiring in your home.

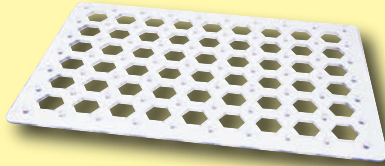

## SNAP WIRES & JUMPER WIRES

The blue **snap wires** are wires used to connect components. They are used to transport electricity and do not affect circuit performance. They come in different lengths to allow orderly arrangement of connections on the base grid.

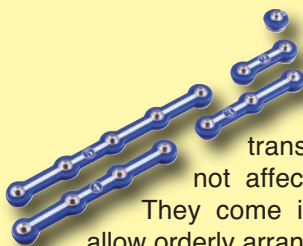

The red and black **jumper wires** make flexible connections for times when using the snap wires would be difficult. They also are used to make connections off the base grid.



Wires transport electricity just like pipes are used to transport water. The colorful plastic coating protects them and prevents electricity from getting in or out.

## BATTERY HOLDER

The **batteries (B1)** produce an electrical voltage using a chemical reaction. This “voltage” can be thought of as electrical pressure, pushing electricity through a circuit just like a pump pushes water through pipes. This voltage is much lower and much safer than that used in your house wiring. Using more batteries increases the “pressure”, therefore, more electricity flows.

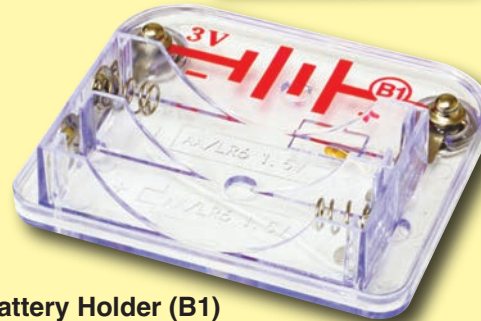

Battery Holder (B1)

## MOTOR

The **motor (M1)** converts electricity into mechanical motion. An electric current in the motor will turn the shaft and the motor blades, and the fan blade if it is on the motor.



Motor (M1)

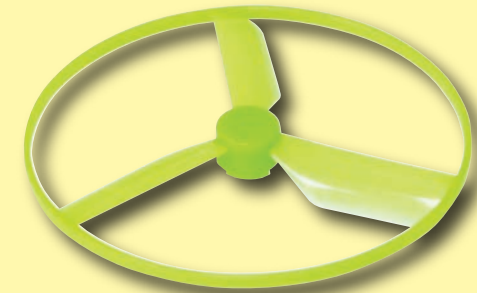

Glow-in-the-dark Fan

How does electricity turn the shaft in the motor? The answer is magnetism. Electricity is closely related to magnetism, and an electric current flowing in a wire has a magnetic field similar to that of a very, very tiny magnet. Inside the motor is a coil of wire with many loops wrapped around metal plates. This is called an electromagnet. If a large electric current flows through the loops, it will turn ordinary metal into a magnet. The motor shell also has a magnet on it. When electricity flows through the electromagnet, it repels from the magnet on the motor shell and the shaft spins. If the fan is on the motor shaft, then its blades will create airflow.

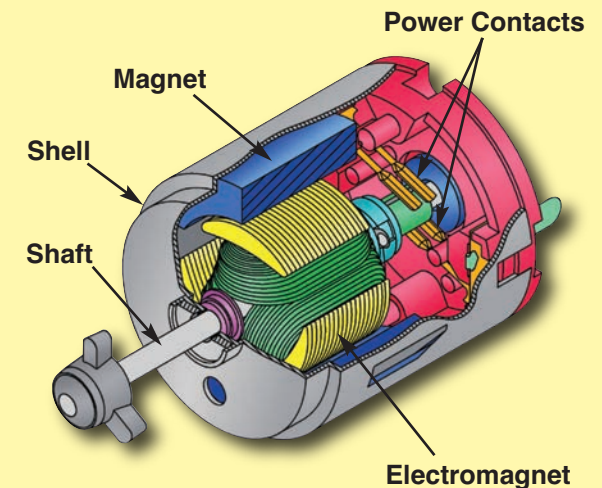

# About Your Snap Circuits® Parts

## COLOR LED

The **color LED (D8)** is a light emitting diode, and may be thought of as a special one-way light bulb. In the “forward” direction, (indicated by the “arrow” in the symbol) electricity flows if the voltage exceeds a turn-on threshold (about 1.5V for red, about 2.0V for green, and about 3.0V for blue); brightness then increases. The color LED contains red, green, and blue LEDs, with a micro-circuit controlling them. A high current will burn out an LED, so the current must be limited by other components in the circuit (though your Snap Circuits® LEDs have internal resistors to protect against incorrect wiring). LEDs block electricity in the “reverse” direction.

Color LED (D8)



## SLIDE & PRESS SWITCHES

The **slide & press switches (S1 & S2)** connect (pressed or “ON”) or disconnect (not pressed or “OFF”) the wires in a circuit. When ON they have no effect on circuit performance. Switches turn on electricity just like a faucet turns on water from a pipe.

Slide & Press Switches (S1 & S2)

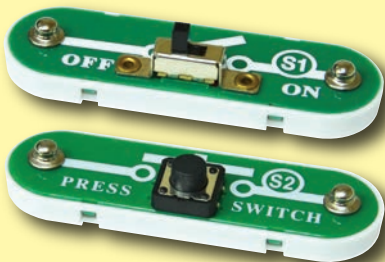

## RESISTORS

Resistors “resist” the flow of electricity and are used to control or limit the current in a circuit. Snap Circuits® Select includes a **100Ω resistor (R1)**. Materials like metal have very low resistance (<1Ω), while materials like paper, plastic, and air have near-infinite resistance. Increasing circuit resistance reduces the flow of electricity.



100Ω Resistor (R1)

## SPEAKER

The **speaker (SP2)** converts electricity into sound by making mechanical vibrations. These vibrations create variations in air pressure, which travel across the room. You “hear” sound when your ears feel these air pressure variations.



Speaker (SP2)

## PHOTOTRANSISTOR

The **phototransistor (Q4)** is a component that uses light to control electric current.



Phototransistor (Q4)

## ELECTRONIC MODULES

The **music, alarm, and space war ICs (U1, U2, and U3)** contain specialized sound-generation ICs and other supporting components (resistors, capacitors, and transistors) that are always needed with them. This was done to simplify the connections you need to make to use them. Schematics for them are available at [www.snapcircuits.net/faq](http://www.snapcircuits.net/faq).

### Music IC:

(+) - power from batteries  
 (-) - power return to batteries  
 OUT - output connection  
 HLD - hold control input  
 TRG - trigger control input  
 Music for a few seconds on power-up, then hold HLD to (+) power or touch TRG to (+) power to resume music.

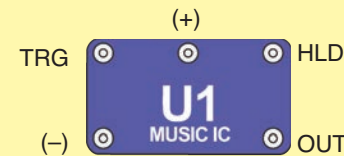

### Alarm IC:

IN1, IN2, IN3 - control inputs  
 (-) - power return to batteries  
 OUT - output connection  
 Connect control inputs to (+) power to make five alarm sounds, see project 13 for configurations.

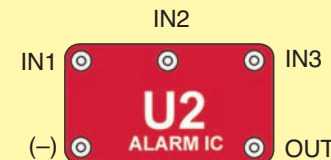

### Space War IC:

(+) - power from batteries  
 (-) - power return to batteries  
 OUT - output connection  
 IN1, IN2 - control inputs  
 Connect each control input to (-) power to sequence through 8 sounds.



# Introduction to Electricity

What is electricity? Nobody really knows. We only know how to produce it, understand its properties, and how to control it. Electricity is the movement of subatomic charged particles (called **electrons**) through a material due to electrical pressure across the material, such as from a battery.

Power sources, such as batteries, push electricity through a circuit, like a pump pushes water through pipes. Wires carry electricity, like pipes carry water. Devices like LEDs, motors, and speakers use the energy in electricity to do things. Switches and transistors control the flow of electricity like valves and faucets control water. Resistors limit the flow of electricity.

The electrical pressure exerted by a battery or other power source is called **voltage** and is measured in **volts** (V). Notice the “+” and “-” signs on the battery; these indicate which direction the battery will “pump” the electricity.

The **electric current** is a measure of how fast electricity is flowing in a wire, just as the water current describes how fast water is flowing in a pipe. It is expressed in **amperes** (A) or **milliamps** (mA, 1/1000 of an ampere).

The “**power**” of electricity is a measure of how fast energy is moving through a wire. It is a combination of the voltage and current (Power = Voltage x Current). It is expressed in **watts** (W).

The **resistance** of a component or circuit represents how much it resists the electrical pressure (voltage) and limits the flow of electric current. The relationship is Voltage = Current x Resistance. When the resistance increases, less current flows. Resistance is measured in **ohms** ( $\Omega$ ), or **kilo ohms** (k $\Omega$ , 1000 ohms).

Nearly all of the electricity used in our world is produced at enormous generators driven by steam or water pressure. Wires are used to efficiently transport this energy to homes and businesses where it is used. Motors convert the electricity back into mechanical form to drive machinery and appliances. The most important aspect of electricity in our society is that it allows energy to be easily transported over distances.

Note that “distances” includes not just large distances but also tiny distances. Try to imagine a plumbing structure of the same complexity as the circuitry inside a portable radio - it would have to be large because we can't make water pipes so small. Electricity allows complex designs to be made very small.

There are two ways of arranging parts in a circuit, in series or in parallel. Here are examples:

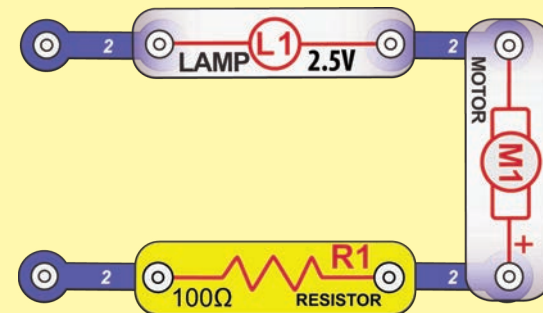

Series Circuit

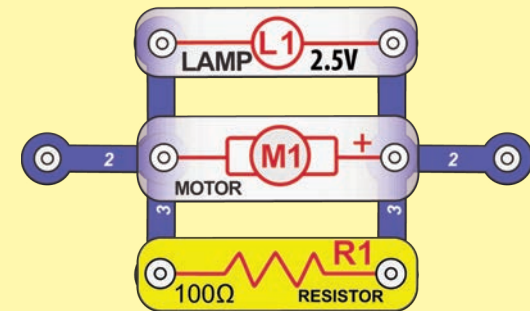

Parallel Circuit

Placing components in series increases the resistance; highest value dominates. Placing components in parallel decreases the resistance; lowest value dominates.

The parts within these series and parallel sub-circuits may be arranged in different ways without changing what the circuit does. Large circuits are made of combinations of smaller series and parallel circuits.

# DOs and DON'Ts of Building Circuits

After building the circuits given in this booklet, you may wish to experiment on your own. Use the projects in this booklet as a guide, as many important design concepts are introduced throughout them. Every circuit will include a power source (the batteries), a resistance (which might be a resistor, lamp, motor, integrated circuit, etc.), and wiring paths between them and back. You must be careful not to create "short circuits" (very low-resistance paths across the batteries, see examples below) as this will damage components and/or quickly drain your batteries. Only connect the ICs using configurations given in the projects, incorrectly doing so may damage them. **Elenco® is not responsible for parts damaged due to incorrect wiring.**

## Here are some important guidelines:

- ALWAYS** USE EYE PROTECTION WHEN EXPERIMENTING ON YOUR OWN.
- ALWAYS** include at least one component that will limit the current through a circuit, such as the speaker, lamp, ICs (which must be connected properly), motor, phototransistor, or resistor.
- ALWAYS** use the LED and switches in conjunction with other components that will limit the current through them. Failure to do so will create a short circuit and/or damage those parts.
- ALWAYS** disconnect your batteries immediately and check your wiring if something appears to be getting hot.
- ALWAYS** check your wiring before turning on a circuit.
- ALWAYS** connect ICs using configurations given in the projects or as per the connection descriptions for the parts.
- NEVER** connect to an electrical outlet in your home in any way.
- NEVER** leave a circuit unattended when it is turned on.

For all of the projects given in this book, the parts may be arranged in different ways without changing the circuit. For example, the order of parts connected in series or in parallel does not matter — what matters is how combinations of these sub-circuits are arranged together.

## Examples of SHORT CIRCUITS - NEVER DO THESE!!!

Placing a 3-snap wire directly across the batteries is a SHORT CIRCUIT.

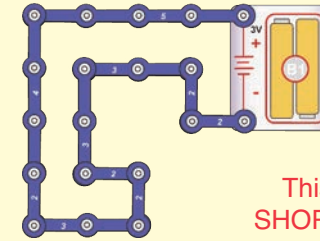

This is also a SHORT CIRCUIT.

When the slide switch (S1) is turned on, this large circuit has a SHORT CIRCUIT path (as shown by the arrows). The short circuit prevents any other portions of the circuit from ever working.

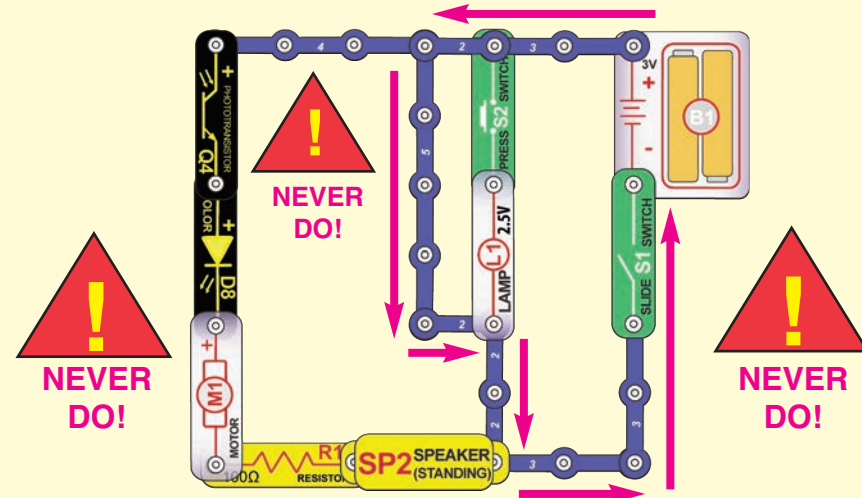

You are encouraged to tell us about new programs and circuits you create. If they are unique, we will post them with your name and state on our website at: [www.snapcircuits.net/learning\\_center/kids\\_creation](http://www.snapcircuits.net/learning_center/kids_creation) Send your suggestions to ELENCO®: [elenco@elenco.com](mailto:elenco@elenco.com).

ELENCO® provides a circuit designer so that you can make your own Snap Circuits® drawings. This Microsoft® Word document can be downloaded from: [www.snapcircuits.net/learning\\_center/kids\\_creation](http://www.snapcircuits.net/learning_center/kids_creation)



**WARNING: SHOCK HAZARD** - Never connect Snap Circuits® to the electrical outlets in your home in any way!



## Advanced Troubleshooting (Adult supervision recommended)

Elenco® is not responsible for parts damaged due to incorrect wiring.

If you suspect you have damaged parts, you can follow this procedure to systematically determine which ones need replacing:

1. **2.5V lamp (L1), motor (M1), speaker (SP2), and battery holder (B1):** Place batteries in holder. Place the 2.5V lamp directly across the battery holder, it should light. Do the same with the motor (motor + to battery +), it should spin to the right at high speed. “Tap” the speaker across the battery holder contacts, you should hear static as it touches. If none work, then replace your batteries and repeat, if still bad then the battery holder is damaged.

2. **Jumper wires:** Use this mini-circuit to test each jumper wire, the lamp should light.

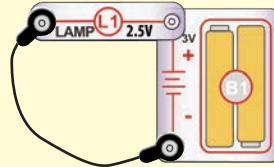

3. **Snap wires:** Use this mini-circuit to test each of the snap wires, one at a time. The lamp should light.

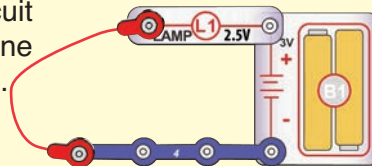

4. **Slide switch (S1) and Press switch (S2):** Build project #1, if the lamp (L1) doesn't light then the slide switch is bad. Replace the slide switch with the press switch to test it.

5. **100Ω resistor (R1) and color LED (D8):** Build project #2 except initially use the speaker (SP2) in place of the resistor, the color LED should light. Then replace the speaker with the resistor; the LED should still light.

6. **Alarm IC (U2):** Build project #110, you should hear a siren. Then make the variants in projects 111-113 to get the sounds described there.

7. **Music IC (U1):** Build project #6. Turn on the switch (S1). A tune should play for a short time and then stop. Push the press switch (S2) and music should play until you release S2. Spin the motor (M1) top with your fingers and you should hear a short tune.

8. **Space war IC (U3) and phototransistor (Q4):** Build project #21, both switches (S1 and S2) should change the sound. Then replace the slide switch with the phototransistor, covering and uncovering it as described in project 22 it should change the sound.

### ELENCO®

150 Carpenter Avenue  
Wheeling, IL 60090 U.S.A.  
Phone: (847) 541-3800  
Fax: (847) 520-0085  
e-mail: [help@elenco.com](mailto:help@elenco.com)  
Website: [www.elenco.com](http://www.elenco.com)

You may order additional / replacement parts  
at:  
[www.snapcircuits.net](http://www.snapcircuits.net)

# Project Listings

Project #	Description	Page #	Project #	Description	Page #	Project #	Description	Page #	Project #	Description	Page #
1	Electric Light	10	35	Prismatic LED	22	69	Using Parts as Conductors	32	104	Motor Space Sounds	45
2	Color Light	10	36	Look at the Lights	22	70	Spin Draw	33	105	Twist & Blink	45
3	Motor Controlled Sounds & Light	11	37	Scattering Light	22	71	Singing Motor	33	106	Light-controlled Lamp	45
4	Light Controlled Color Light	11	38	Power Shifter	22	72	Visual Volume	34	107	Motor-controlled Lamp	45
5	Musical Doorbell	12	39	Spin Sound	23	73	Eurosiren Volume	34	108	Multi-Speed Light Fan	46
6	Music Circuit	12	40	Loud Spin Sound	23	74	Funky Volume	34	109	Light Disrupter	46
7	Space War Alarm Combo	12	41	Nifty Noises	23	75	Fire-Light Siren	34	110	Alarm Circuit	47
8	Flying Saucer	13	42	Loud Nifty Noises	23	76	Crooks & Cars	34	111	Machine Gun	47
9	Fan	13	43	Photo LED Control	24	77	Static Gun	34	112	Fire Engine	47
10	Super Circuit	14	44	Fuse	24	78	Pop On, Pop Off	35	113	European Siren	47
11	Another Super Circuit	14	45	Mind Reader Game	25	79	Crazy Combo	35	114	Quieter Alarm Circuits	47
12	Yet Another Super Circuit	14	46	Wave & Watch	26	80	Alien Alarm	35	115	Quieter Machine Gun	47
13	European Siren & Light	15	47	Reflection Detector	26	81	Two-way Light Switch	36	116	Quieter Fire Engine	47
14	Siren & Light	15	48	Shine on Siren	27	82	Machine Gun Buzz	36	117	Quieter European Siren	47
15	Silly Sound & Light	15	49	Shooting Sounds	27	83	Double Flash Machine Gun	36	118	Pencil Alarm	48
16	Fire Engine Siren & Light	15	50	Song & Siren	27	84	Light Makes Light	37	119	Pencil Sound	48
17	Machine Gun Sound & Light	15	51	Ambulance Melody	27	85	Go & Glow	37	120	Pencil Alarm Variant	48
18	Conduction Detector	16	52	Static Song	27	86	Same or "NOT"	37	121	Another Pencil Alarm Variant	48
19	Light Controlled Music	16	53	Mixed Up Music	28	87	This OR That	38	122	Simple Water Alarm	49
20	Finger Controlled Music	16	54	Blaster Disaster	28	88	This AND That	38	123	Simple Salt Water Alarm	49
21	Space War	17	55	Siren & Song	28	89	Neither This NOR That	39	124	Ambulance Water Alarm	49
22	Photo Space War	17	56	Ambulance Song	28	90	NOT This AND That	39	125	Ambulance Contact Alarm	49
23	Super Space War	18	57	Space Battle	29	91	Music AND Gate	40	126	Symphony of Sounds	50
24	Super Photo Space War	18	58	Bizarre Blinker	29	92	Touch & Go	40	127	Photo Symphony of Sounds	50
25	Quieter Super Space War	18	59	Periodic Sounds	29	93	Flash & Tone	40	128	Incandescent Symphony of Sounds	50
26	Quieter Super Photo Space War	18	60	Blinking Double Flashlight	29	94	Fan FLash Energy	41	129	Siren Symphony of Sounds	50
27	Lamp & Fan in Series	19	61	Motor-Controlled Sounds	30	95	Fun with the Alarm IC	41	130	Machine Gun Symphony of Sounds	50
28	Light Dimmer	19	62	Spin & Shoot	30	96	Music Alarm Combo	42	131	Euro Siren Symphony of Sounds	50
29	Lamp & Fan in Parallel	19	63	Spin Out Siren	30	97	Hit the Target	42	132	2-Light Symphony of Sounds	51
30	Hear the Motor	20	64	Whirl Out Warning	30	98	Water Space War	42	133	Super Symphony of Sounds	51
31	Hear the Motor with Light	20	65	Turn a Tune	30	99	Light / Water Space War	42			
32	Listen to the Light	21	66	Spinning Rings	31	100	OR / AND Space War Light	42			
33	Two-Speed Fan	21	67	Strobe the House Lights	31	101	Sing & Fling	43			
34	Prismatic Film	22	68	Race Game	32	102	Power Pitch	43			
						103	Morse Code	44			

# Project 1

# Electric Light

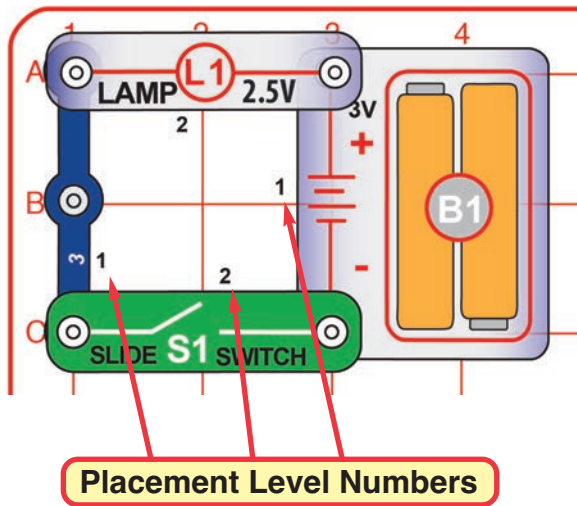

Snappy says when you turn on the slide switch, electricity flows from the batteries through the lamp and back to the battery through the switch. If the switch is off, the flow of electricity is blocked, and the lamp won't light.

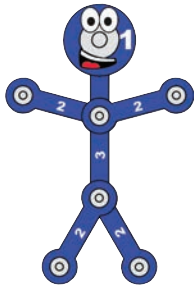

Snap Circuits® uses electronic blocks that snap onto a clear plastic grid to build different circuits. These blocks have different colors and numbers on them so that you can easily identify them.

Build the circuit shown on the left by placing all the parts with a black 1 next to them on the board first. Then, assemble parts marked with a 2. Install two (2) "AA" batteries (not included) into the battery holder (B1) if you have not done so already.

Turn on the slide switch (S1), and

# Project 2

# Color Light

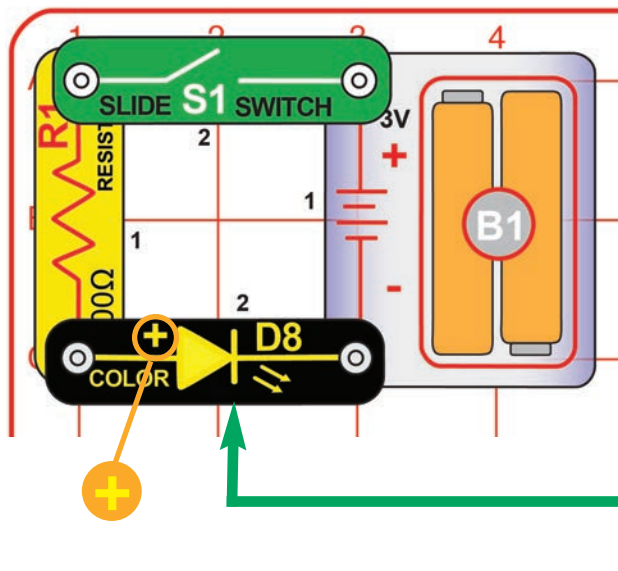

Turn on the slide switch (S1), and enjoy the light show from the color LED (D8). For best effects, place the egg on the color LED, and dim the room lights.

Try reversing the position of the slide switch (S1), 100Ω resistor (R1), and color LED (D8), separately. Reversing the switch and resistor has no effect, but the LED does not work in reverse.

Snappy says the color LED actually contains separate red, green, and blue lights, with a micro-circuit controlling them.

LEDs are like valves, because they only let electric current flow in one direction.

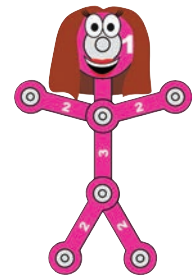

# Project 3 Motor Controlled Sounds & Light

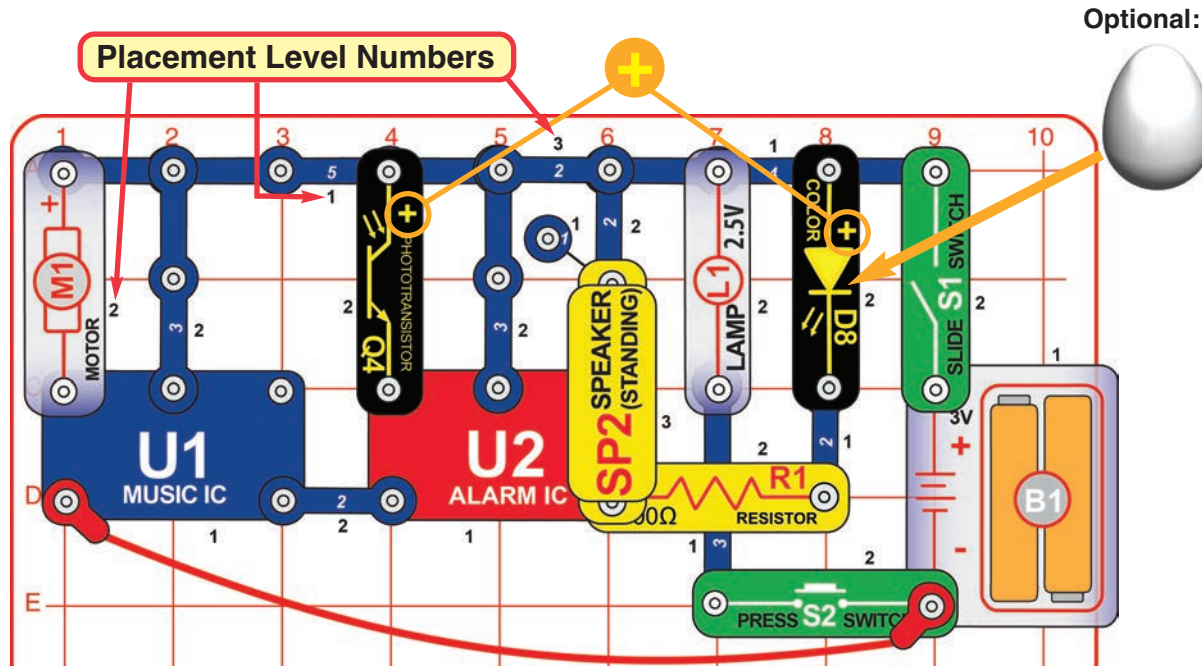

Optional:

Build the circuit shown on the left by placing all the parts with a black 1 next to them on the board first. Then, place parts marked with a 2, and then parts with a 3. Install two (2) "AA" batteries (not included) into the battery holder (B1) if you have not done so already. If desired, place the egg on the color LED (D8).

Turn on the slide switch (S1). The color LED lights and you hear a siren for a few seconds, then they stop. Spin the motor (M1) top with your fingers to re-start the sound and LED. Also, push the press switch (S2) to light the lamp (L1).

You can change the siren sound by shining a bright light on the phototransistor (Q4), or covering it if the room light was already bright.

# Project 4 Light Controlled Color Light

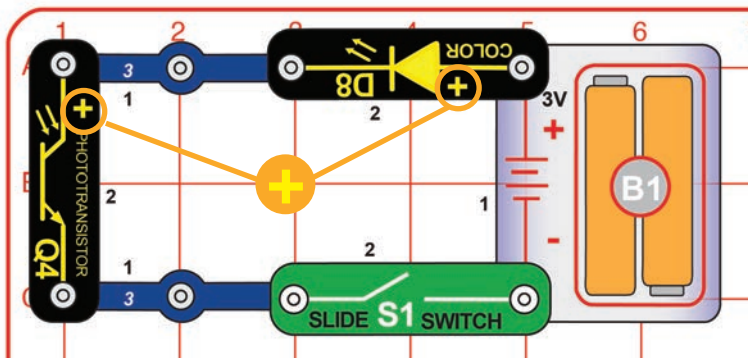

Turn on the slide switch (S1). Vary the amount of light shining on the phototransistor (Q4) to change the brightness of the color LED (D8).

The phototransistor (Q4) uses light to control electric current.

Parts like this are used in a number of ways that affect our lives. For example, you may have streetlights in your neighborhood that turn on when it starts getting dark and turn off in the morning.

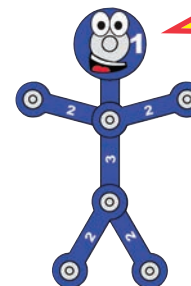

# Project 5

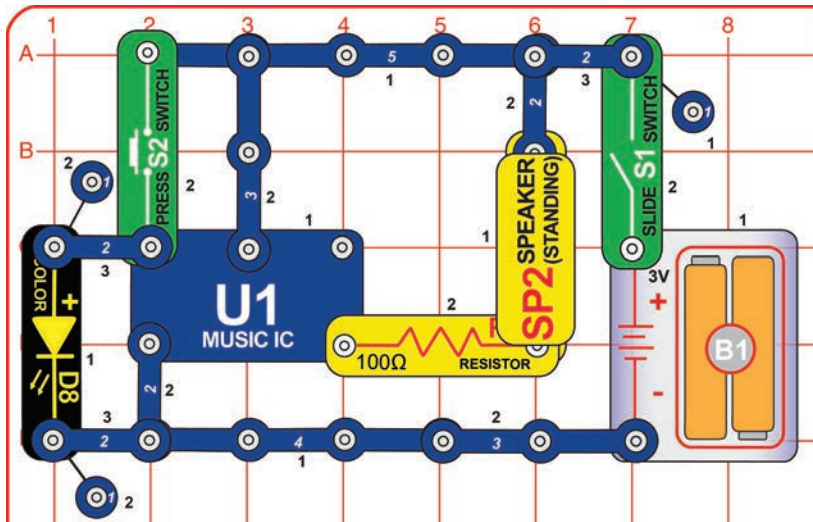

Turn on the slide switch (S1). A tune may play for a sort time and then stop. When there is no sound, push the press switch (S2) to play a tune. The press switch acts like a musical doorbell.

The lower-right snap of the music IC is like an electrical gate, opening and closing quickly to let small bursts of electric current flow in. The bursts of electric current also flow through the speaker (which produces sound). The music IC produces the tune by adjusting the pattern of current bursts through the speaker.

Musical integrated circuits are used to entertain young children in many of the toys and chairs made to hold infants. If the music is replaced with words, the child can also learn while they are entertained. Because of great advances in miniaturization, many songs are stored in a circuit no bigger than a pinhead.

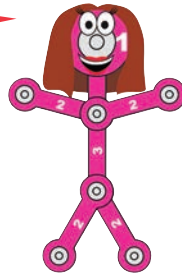

# Project 6 Music Circuit

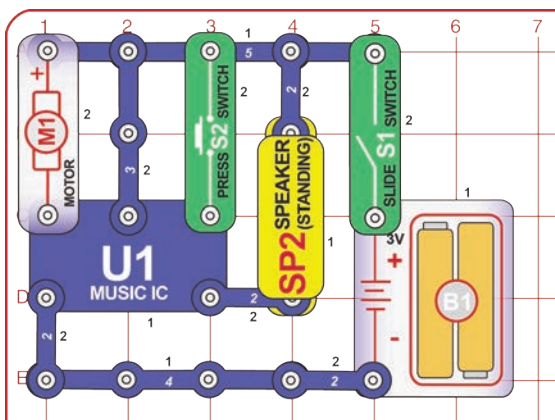

Build the circuit shown on the left. Turn on the switch (S1). A tune plays for a short time and then stops. Push the press switch (S2) and music plays until you release S2. Spin the motor (M1) top with your fingers to play a short tune.

# Project 7 Space War Alarm Combo

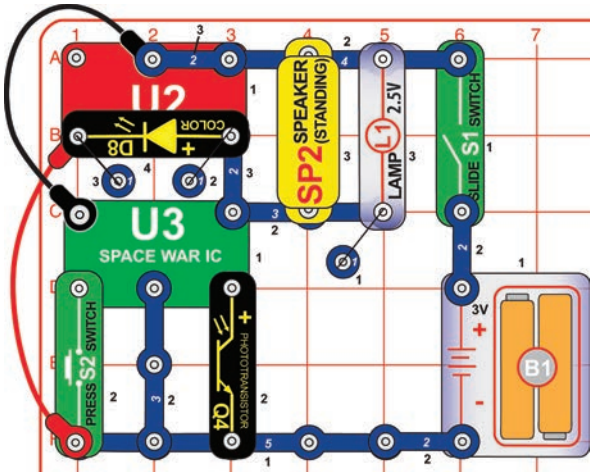

Build the circuit shown. Turn on the slide switch (S1), press the press switch (S2) several times, and cover and uncover the phototransistor (Q4) to hear all the sound combinations.

# Project 8

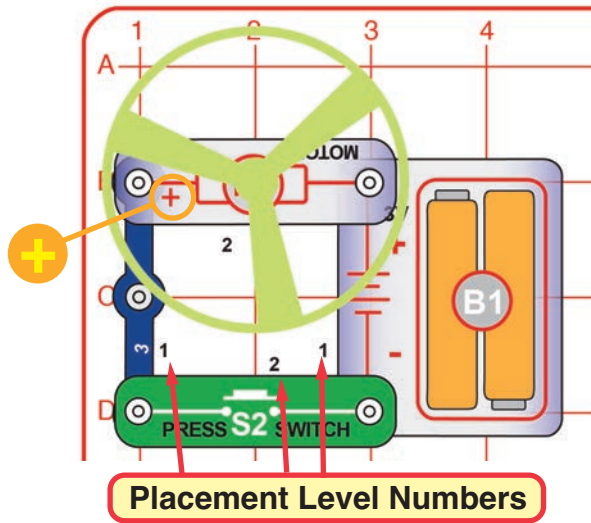

Build the circuit shown on the left by placing all the parts with a black 1 next to them on the board first. Then, assemble parts marked with a 2. Install two (2) "AA" batteries (not included) into the battery holder (B1) if you have not done so already.

Push the press switch (S2) until the motor reaches full speed, then release it. The fan blade should rise and float through the air like a flying saucer. Be careful not to look directly down on fan blade when it is spinning.

If the fan doesn't fly off, then press the switch several times rapidly when it is at full speed. The motor spins faster when the batteries are new.

The glow fan will glow in the dark. It will glow best after absorbing sunlight for a while. The glow fan is made of plastic, so be careful not to let it get hot enough to melt. The glow looks best in a dimly lit room.

The air is being blown down through the blade and the motor rotation locks the fan on the shaft. When the motor is turned off, the blade unlocks from the shaft and is free to act as a propeller and fly through the air. If speed of rotation is too slow, the fan will remain on the motor shaft because it does not have enough lift to propel it.

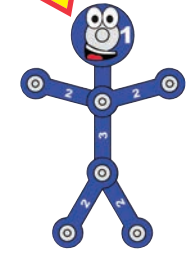

**WARNING:** Moving parts. Do not touch the fan or motor during operation. Do not lean over the motor. Fan may not rise until switch is released.

# Project 9

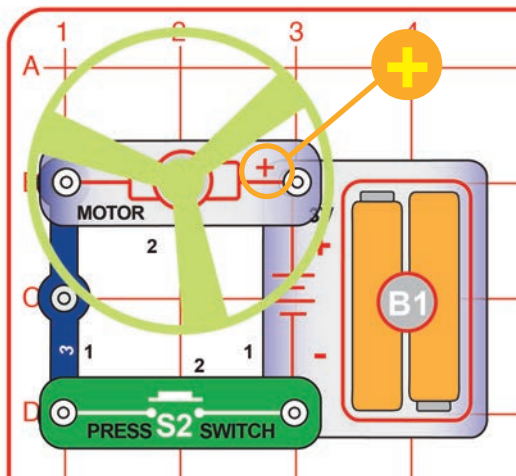

Use the preceding circuit, but reverse the position of the motor (M1). Push the press switch (S2) to spin the motor and glow fan.

Here the glow fan is blowing air upward; place your hand a short distance above the motor and you should be able to feel it. In this project electrical power was changed into mechanical power. Motors like this one are used in battery powered equipment requiring rotary motion, such as a cordless drill, electric toothbrush, and toys. An electric motor is much easier to control than gas or diesel engines.



**WARNING:** Moving parts. Do not touch the fan or motor during operation. Do not lean over the motor.



# Project 10

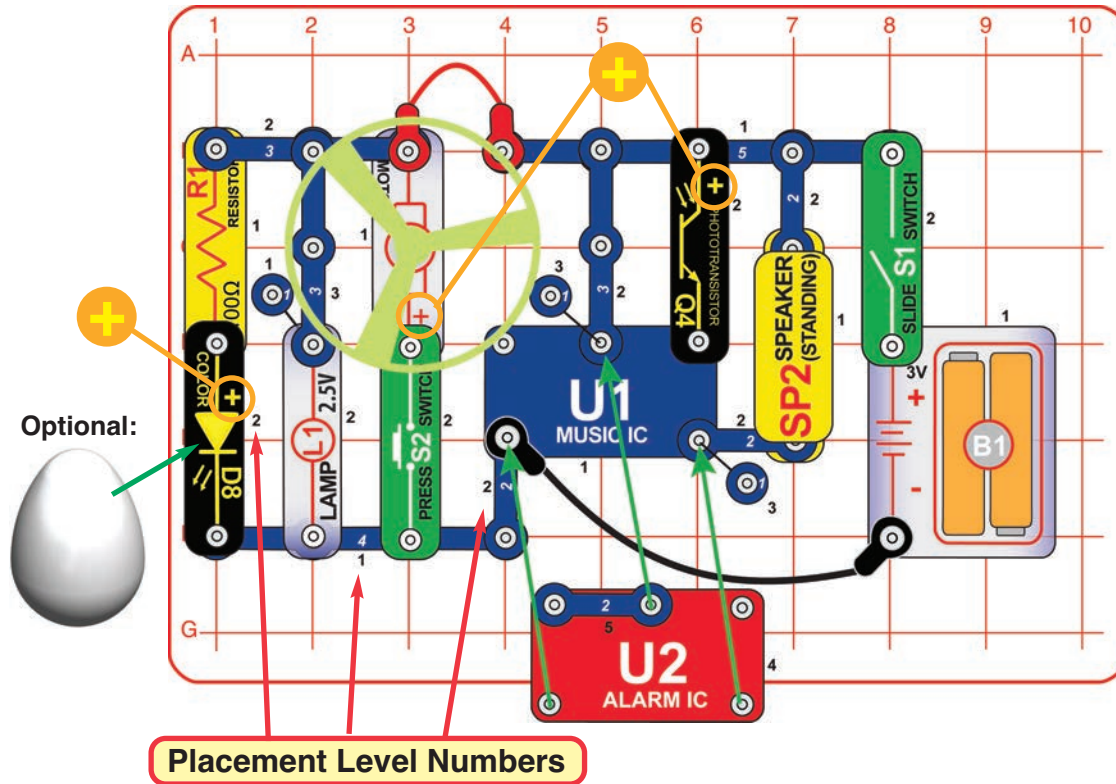

# Super Circuit

Turn on the slide switch (S1) to make sound and lights. Some of the sound may stop after a few seconds; if it does, shine a bright light on the phototransistor (Q4) to re-start the sound. If the sound never shuts off then cover the phototransistor. (you may need to smother Q4 with your hand or take the circuit into a dark room).

Push the press switch (S2) until the motor reaches full speed, then release it. The fan blade should rise and float through the air like a flying saucer. Be careful not to look directly down on fan blade when it is spinning.

If the fan doesn't fly off, then press the switch several times rapidly when it is at full speed. The motor spins faster when the batteries are new. If you don't want the fan to fly off then reverse the orientation of the motor.

This circuit is shown on the front of the Snap Circuits® Select box, use that picture to help in building it.



**WARNING:** Moving parts. Do not touch the fan or motor during operation. Do not lean over the motor. Fan may not rise until switch is released.



# Project 11 Another Super Circuit

To change the sound, move the 2-snap wire that is on top of the alarm IC (U2) one space to the right.



# Project 12 Yet Another Super Circuit

To change the sound, remove the 2-snap wire that is on top of the alarm IC (U2).

# Project 13

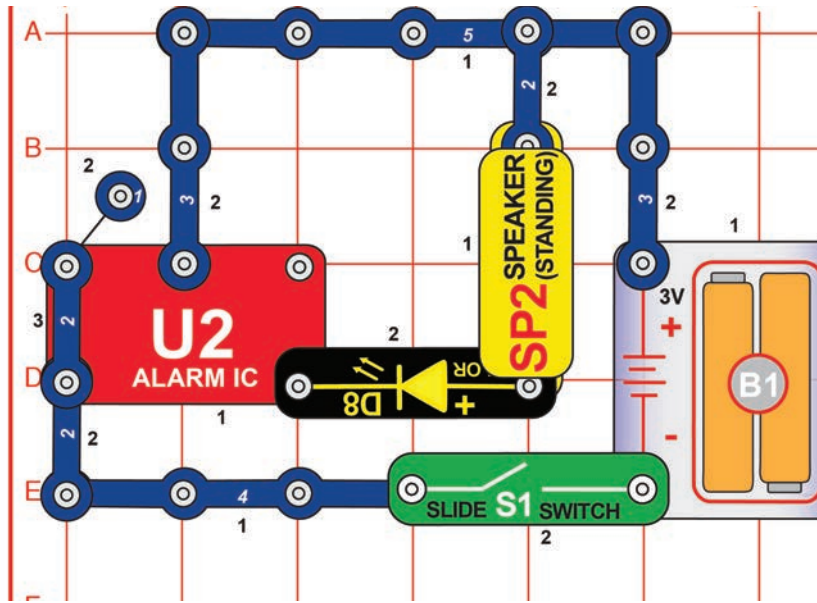

The lower-right snap of the alarm IC (U2) is like an electrical gate, opening and closing quickly to let small bursts of electric current flow in. The bursts of electric current also flow through the color LED (lighting it) and the speaker (which produces sound). The alarm IC produces the different siren sounds by adjusting the pattern of current bursts through the speaker.

Turn on the slide switch (S1). A European siren sounds and the color LED (D8) flashes.

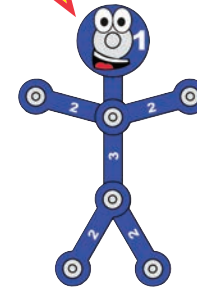

## Project 14 Siren & Light

Modify the project 13 circuit by removing the 2-snap wire and 1-snap wire that are on top of the alarm IC (U2), as shown.



## Project 15 Silly Sound & Light

Modify the preceding circuit by removing the 3-snap wire that is on top of the alarm IC (U2), and adding three 2-snap wires around it, as shown.

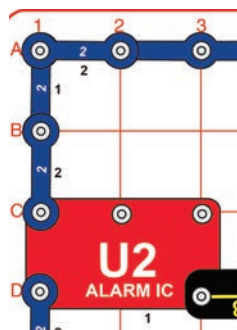

## Project 16 Fire Engine Siren & Light

Modify the project 13 circuit by moving the 2-snap wire that is on top of the alarm IC (U2), as shown.

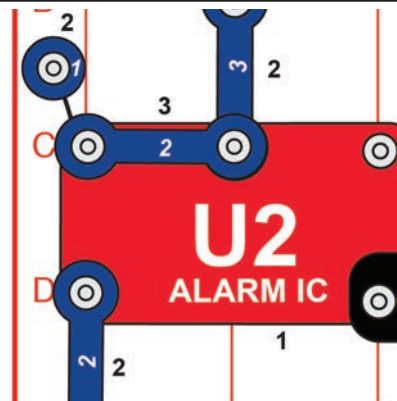

## Project 17 Machine Gun Sound & Light

Modify the project 13 circuit by moving the 2-snap wire and 1-snap wire that are on top of the alarm IC (U2), as shown.



# European Siren & Light



# Project 18

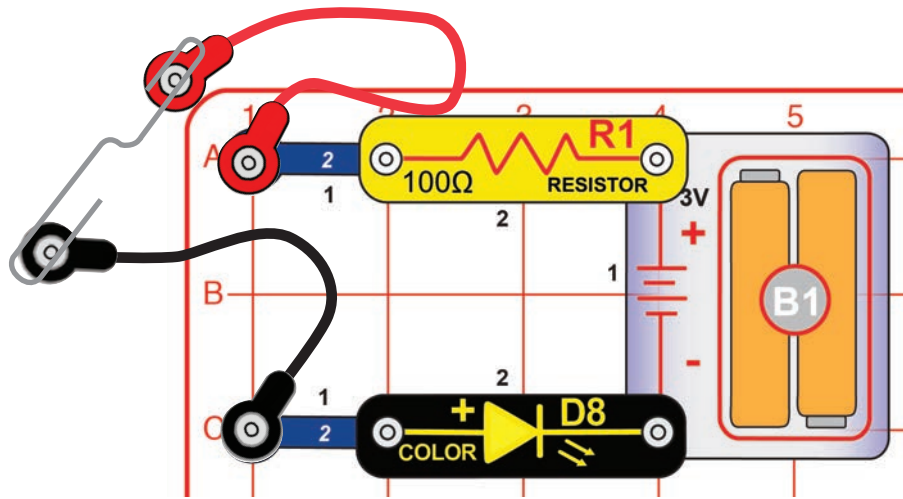

# Conduction Detector

Build the circuit as shown. When you place a metal paper clip across the snaps on the red & black wires as shown in the drawing, current flows from the batteries (B1) through the resistor (R1), through the paperclip, through the color LED (D8), and back to the battery. The paper clip completes the circuit and can current flow through the LED.

Now replace the metal paperclip with other materials in your home, and see if the LED lights. This circuit can be used to see if a material like plastic is a good conductor of electricity, or a poor conductor of it.

Materials that have low resistance to the flow of electricity are called conductors, and materials that have high electrical resistance are called insulators.

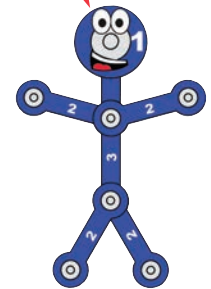

# Project 19

# Light Controlled Music

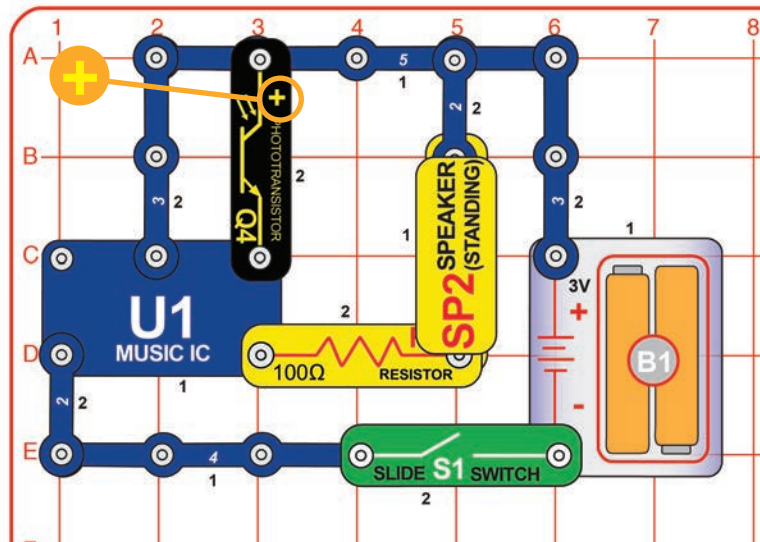

Turn on the slide switch (S1) and you hear a tune. The sound may stop after a few seconds; if it does, shine a bright light on the phototransistor (Q4) to turn the sound back on. If the sound never shuts off then cover the phototransistor. (you may need to smother Q4 with your hand or take

# Project 20 Finger Controlled Music

Use the preceding circuit, but replace the phototransistor (Q4) with the press switch (S2). Turn on the slide switch (S1). A tune may play for a short time and then stop. When there is no sound, push the press switch (S2) to hear music; if you release S2 then the music stops.

# Project 21

# Space War

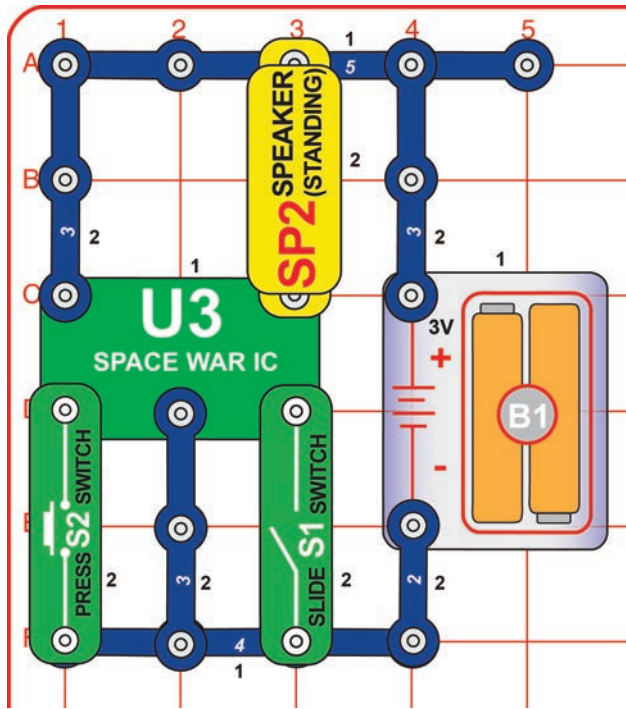

Build the circuit shown on the left, which uses the space war IC (U3). Activate it by flipping the slide switch (S1) or pressing the press switch (S2); do both several times and in combination. You will hear an exciting range of sounds, as if a space war is raging!

Like the other integrated circuits, the space war IC is a super-miniaturized electronic circuit that can play a variety of cool sounds stored in it by using just a few extra components.

In movie studios, technicians are paid to insert these sounds at the precise instant a gun is fired. Try making your sound occur at the same time an object hits the floor. It is not as easy as it sounds.

The upper-right snap of the space war IC is like an electrical gate, opening and closing quickly to let small bursts of electric current flow in. The bursts of electric current also flow through the speaker (which produces sound). The space war IC produces the different sounds by adjusting the pattern of two separate current bursts through the speaker.

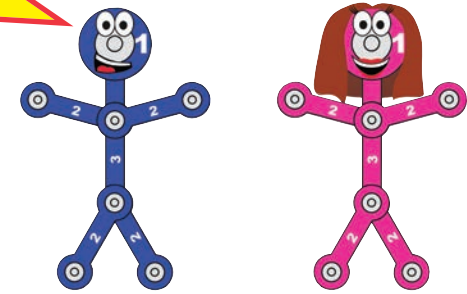

# Project 22

# Photo Space War



Use the preceding circuit, but replace the slide switch (S1) with the phototransistor (Q4), with "+" toward U3. The circuit immediately makes noise (unless the room is very dark). Cover and uncover the phototransistor to change the sound, or push the press switch (S2). Do both several times and in combination.

Note: the phototransistor is very sensitive, and even a small amount of light may be enough for it to activate the space war IC. You may need to be covering/uncovering the phototransistor in a relatively dark room.

## Project 23

## Super Space War

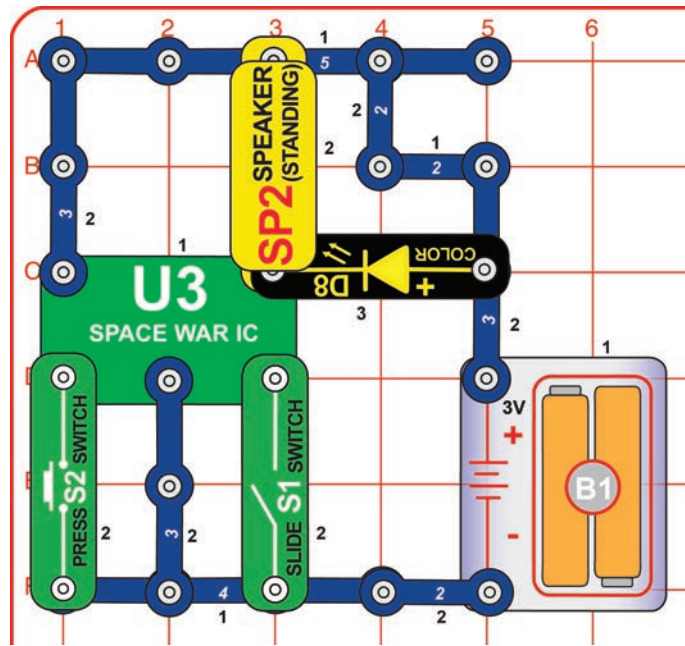

Build the circuit shown on the left. Activate it by flipping the slide switch (S1) or pressing the press switch (S2); do both several times and in combination. You will hear an exciting range of sounds plus light, as if a space war is raging!

## Project 24 Super Photo Space War

Use the preceding circuit, but replace the slide switch (S1) with the phototransistor (Q4), with "+" toward U3. The circuit immediately makes noise (unless the room is vary dark), and the color LED (D8) lights. Cover and uncover the phototransistor to change the sound, or push the press switch (S2). Do both several times and in combination.

## Project 25

## Quieter Super Space War

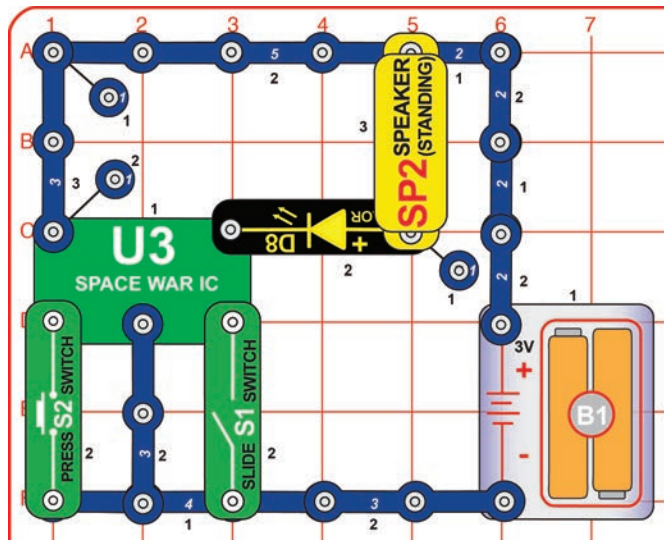

This circuit is just like project 23, but not as loud. Activate it by flipping the slide switch (S1) or pressing the press switch (S2); do both several times and in combination.

## Project 26 Quieter Super Photo Space War

Use the preceding circuit, but replace the slide switch (S1) with the phototransistor (Q4), with "+" toward U3. The circuit immediately makes noise (unless the room is vary dark), and the color LED (D8) lights. Cover and uncover the phototransistor to change the sound, or push the press switch (S2). Do both several times and in combination.

## Project 27 Lamp & Fan in Series

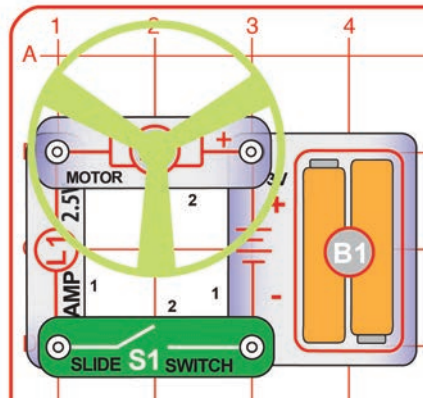

Turn on the slide switch (S1). The lamp (L1) lights and the motor (M1) spins the glow fan. Notice how the lamp gets a little less bright as the motor speeds up.

**WARNING:** Moving parts. Do not touch the fan or motor during operation. Do not lean over the motor.

## Project 28 Light Dimmer

Use the preceding circuit, but remove the glow fan from the motor (M1). Turn on the slide switch (S1), and watch how the lamp (L1) starts out bright, but gets dim as the motor speeds up. Next, turn off the circuit and hold the motor top with your fingers so it can't spin, then turn on the switch and see how bright the lamp is.

The faster the motor is spinning, the less electricity it needs. The more electricity flows, the brighter the lamp gets. The motor needs the most electricity when it starts up, making the lamp brightest. Without the fan, the motor can spin fast and needs little electricity, making the lamp dim.



## Project 29

## Lamp & Fan in Parallel

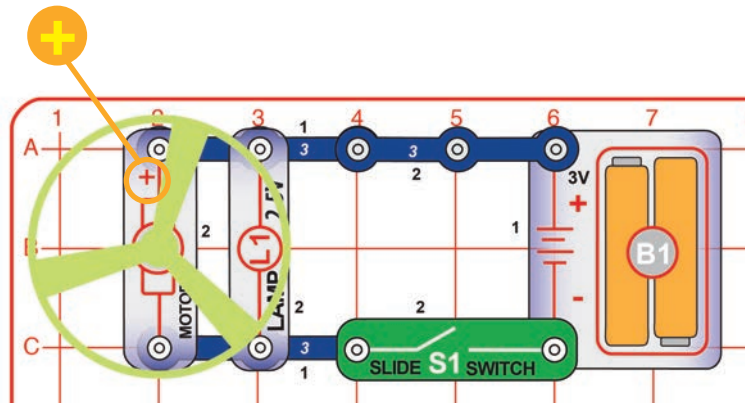

Turn on the slide switch (S1). The lamp (L1) lights and the motor (M1) spins the glow fan.

Compare this circuit to the circuit in project 27, and also try removing the fan as done in project 28. Notice how the lamp brightness is not affected by the motor speed, and the motor starts a little

**WARNING:** Moving parts. Do not touch the fan or motor during operation. Do not lean over the motor.

Here the motor and lamp are connected in parallel. Each has its own path to the batteries, so they don't affect each other.

An advantage of connecting parts in parallel is that if one of them burns out, the other will still work. The switch is connected in series with both the lamp and motor, so if it breaks, nothing will work. Electricity flows out of the batteries, through either the motor or lamp, then back to the batteries through the switch.

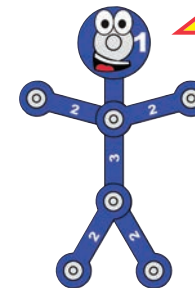



# Project 30

# Hear the Motor

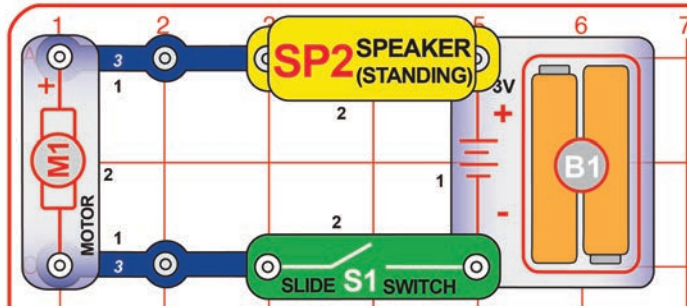

Turn on the slide switch (S1). If the shaft on the motor (M1) isn't spinning, then give it a push to get started. Listen to the motor.

You can also try this circuit with the glow fan on the motor.

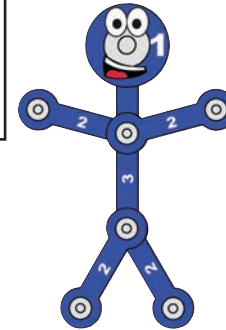

Why does the motor make sound? A motor uses magnetism to convert electrical energy into mechanical spinning motion. As the motor shaft spins around it connects/disconnects several sets of electrical contacts to give the best magnetic properties. As these contacts are switched, an electrical disturbance is created, which the speaker



# Project 31

# Hear the Motor with Light

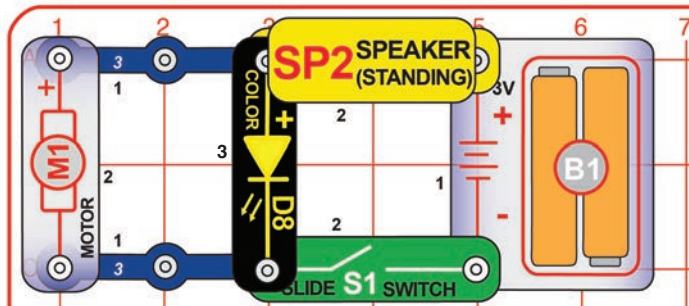

Turn on the slide switch (S1), and look at the brightness of the color LED (D8). If the shaft on the motor (M1) isn't spinning, then give it a push to get started. Try it three ways: with no fan on the motor, with the glow fan on the motor, and keeping the motor from spinning with your fingers. When the motor is spinning, you will hear noise from the speaker (SP).

The motor needs a lot of electricity to start spinning, but needs less the faster it is spinning. When kept from spinning by your fingers, the motor sucks up all the electricity, leaving none to light the color LED. With the fan on the motor, the LED gets enough electricity to light. When the motor is spinning without the fan, the LED gets more electricity and is brighter.



## Project 32

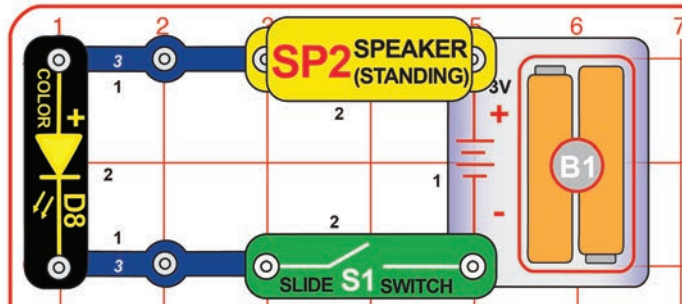

Turn on the slide switch (S1). The color LED (D8) changes colors in a repeating pattern, and you hear a clicking sound from the speaker (SP2).

What makes the clicking sound? The color LED actually contains separate red, green, and blue lights, with a microcircuit controlling them. Each time the LED changes colors, the voltage across it changes. Each time the voltage changes, you hear a “click” from the speaker.

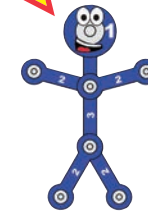

## Project 33

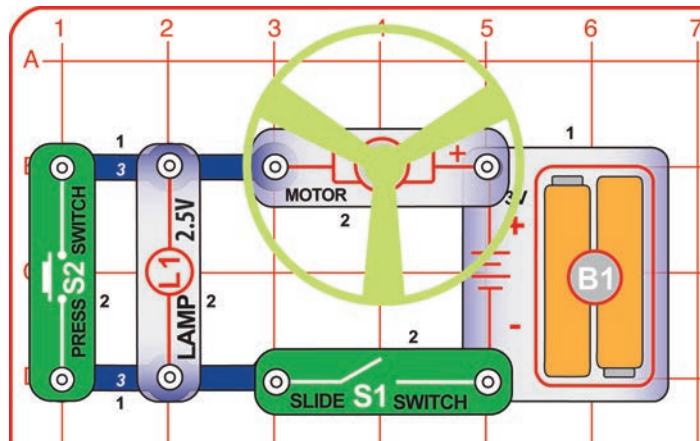

Turn on the slide switch (S1); the motor (M1) spins the glow fan and the lamp (L1) lights. Push the press switch (S2) to bypass the lamp and increase the fan speed.

When the lamp is on, the fan spins slower because the battery power is divided between the motor and lamp. Pushing S2 allows electricity to bypass the lamp, so all the battery power is available to the motor, so the fan spins faster.



**WARNING:** Moving parts. Do not touch the fan or motor during operation. Do not lean over the motor.

## Listen to the Light

## Two-Speed Fan

# Project 34 Prismatic Film

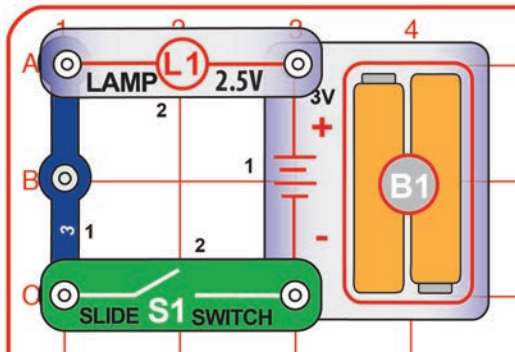

Prismatic film separates light into different colors. White light is a combination of all colors.

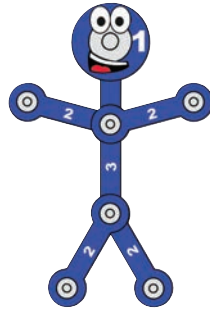

This is the same circuit as project 1, but you will view it differently. Turn on the switch (S1), and view the lamp (L1) through the prismatic film (the clear slide). Prismatic film makes interesting light effects.

# Project 35 Prismatic LED

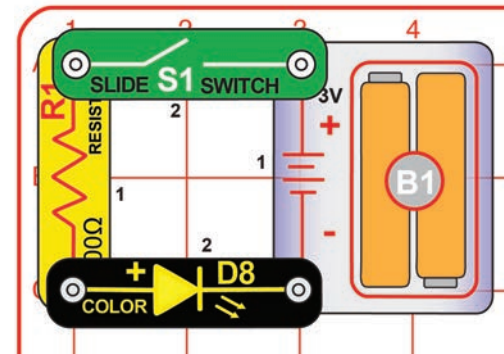

This is the same circuit as project 2, but you will view it differently. Turn on the switch (S1), and view the LED through the prismatic film (the clear slide). Prismatic film makes interesting light

# Project 36 Look at the Lights

View different light sources in and around your home through the prismatic film.

# Project 37 Scattering Light

Use the project 34 and 35 circuits, but view the lamp and color LED through various semi-transparent liquids, glassware, and plastics. Juices, jello, and cloudy glass or plastic work well.

Semi-transparent materials scatter the light without completely blocking it, so a wide area of the liquid or material is lit up by the light. This happens in the egg LED



# Project 38 Power Shifter

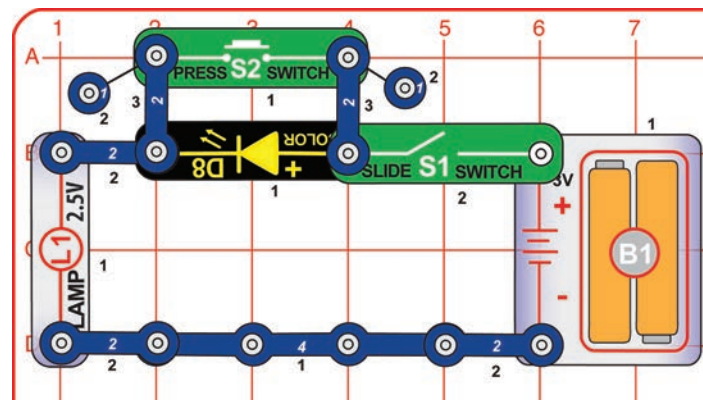

When you turn on the slide switch (S1), the color LED (D8) is on and the lamp (L1) is off.

Push the press switch (S2) to bypass the LED. The lamp turns on and the LED turns off. This shows how switches can be used to shift power between different devices.

# Project 39

Build the circuit shown on the right, but leave the fan off the motor (M1). When you turn on the slide switch (S1), the music may play for a short time and then stop. After the music has stopped, spin the motor with your fingers. The music should play again for a short time, then stop.

Resistors are used throughout electronics to limit the amount of current that flows.



# Spin Sound

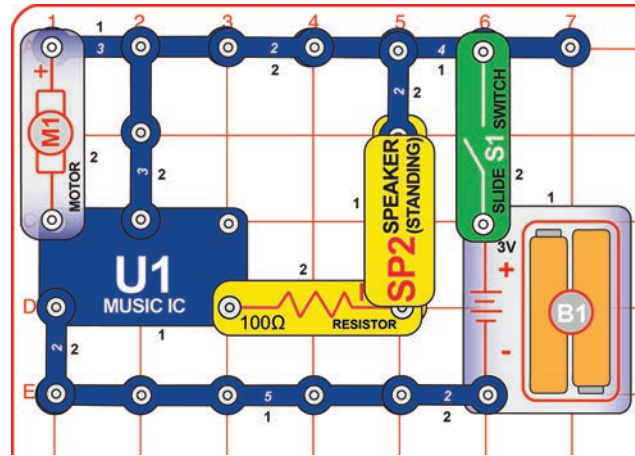

# Project 40 Loud Spin Sound

Use the preceding circuit but replace the 100Ω resistor with a 3-snap wire. Now the sound is louder. In this project, you changed the amount of current that goes through the speaker (SP2) and increased the sound output of the speaker.

# Project 41

Build the circuit shown. Turn it on, press the press switch (S2) several times, and cover the phototransistor (Q4) several times to hear all the sound combinations.

A photoresistor is a light-controlled variable resistor. The resistance of the photoresistor decreases with increasing light intensity.

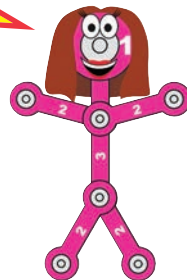

# Nifty Noises

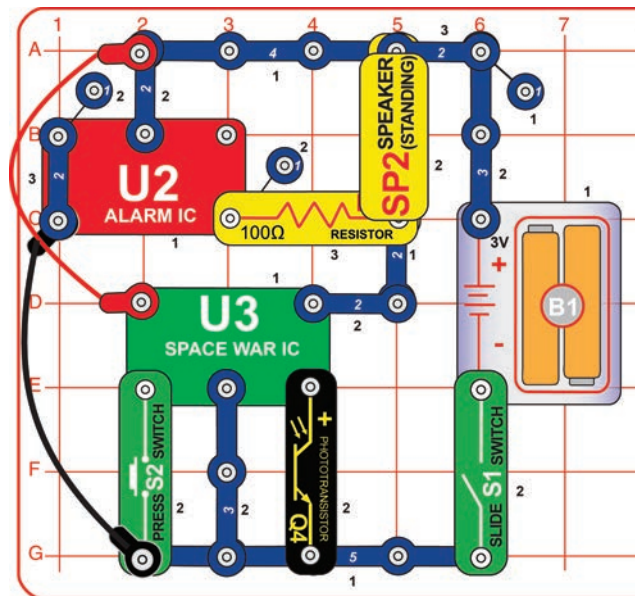

# Project 42 Loud Nifty Noises

Use the preceding circuit but make the sound from the alarm IC (U2) louder by replacing the 100Ω resistor (R1) with the 2.5V lamp (L1).



# Project 43

# Photo LED Control

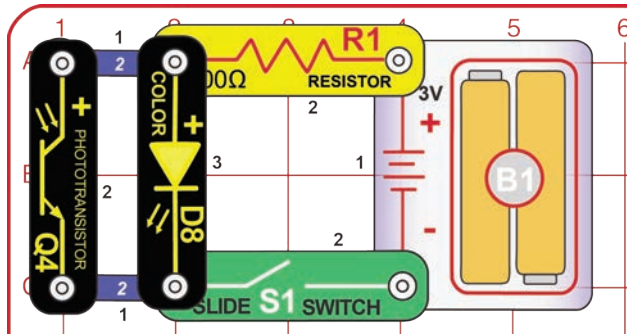

Build the circuit shown on the left. Cover the phototransistor (Q4) and turn on the switch (S1); the color LED (D8) should be changing colors.

Now shine a bright light on the phototransistor and the color LED should get dim or turn off. Vary the amount of light on the phototransistor and see how bright the color LED is. Try using a flashlight in a dimly lit room.

# Project 44

# Fuse

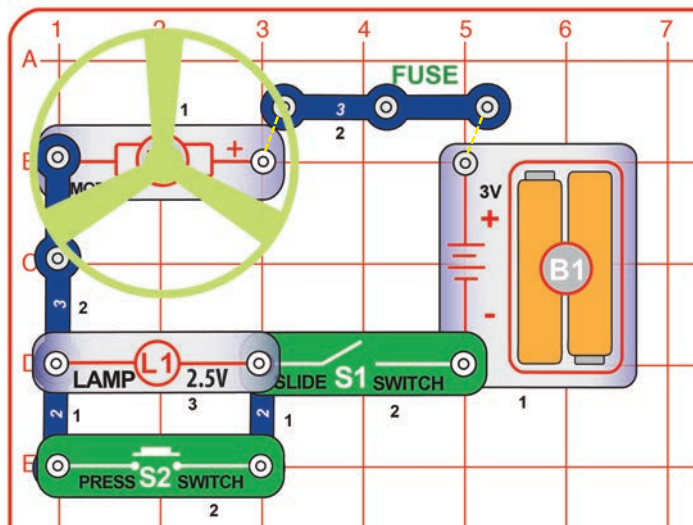

Pretend the 3-snap wire marked fuse in the drawing on the left is a device that will open the circuit if too much current is taken from the battery. When you close the slide switch (S1), current flows from the batteries through the slide switch (S1), the lamp (L1), motor (M1), and back to the battery (B1). When press switch (S2) is closed, the light is shorted and motor speed increases due to an increase in current to the motor. While still holding press switch (S2) down, remove the 3-snap wire marked fuse and notice how everything stops. Until the fuse is replaced, the open circuit path protects the electronic parts. If fuses did not exist, many parts could get hot and even start fires. Replace the 3-snap wire and the circuit should return to normal.

Many electronic products in your home have a fuse that will open when too much current is drawn. Can you name some?

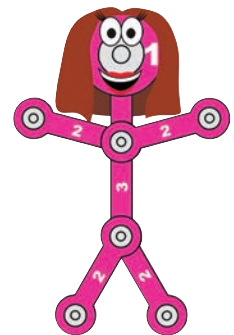

**WARNING:** Moving parts. Do not touch the fan or motor during operation. Do not lean over the motor.

# Project 45

# Mind Reader Game

Build the circuit below. It uses the red jumper wire and a 3-Snap Wire as “shorting bars”.

**Setup:** Player 1 sets the target by placing the 3-snap shorting bar under the paper on column 2, 3 or 4. Player 2 must NOT know where the shorting bar is located under the paper.

The object is for Player 2 to guess the location by placing the loose end of the red jumper wire on the 5-snap wire at positions A, B, or C and then pressing the press switch (S2). If Player 2 places the red jumper wire at the correct position, the sounds played indicates a “hit”. He keeps guessing until he hits. After each hit, remove the 3-snap shorting bar and slide the switch off and

on to reset the sound.

Player 2 then sets the 2, 3, 4 side and player 1 tries his luck.

Play multiple rounds and see who gets the best overall score. The winner will be the player who is best at reading his opponent’s mind.

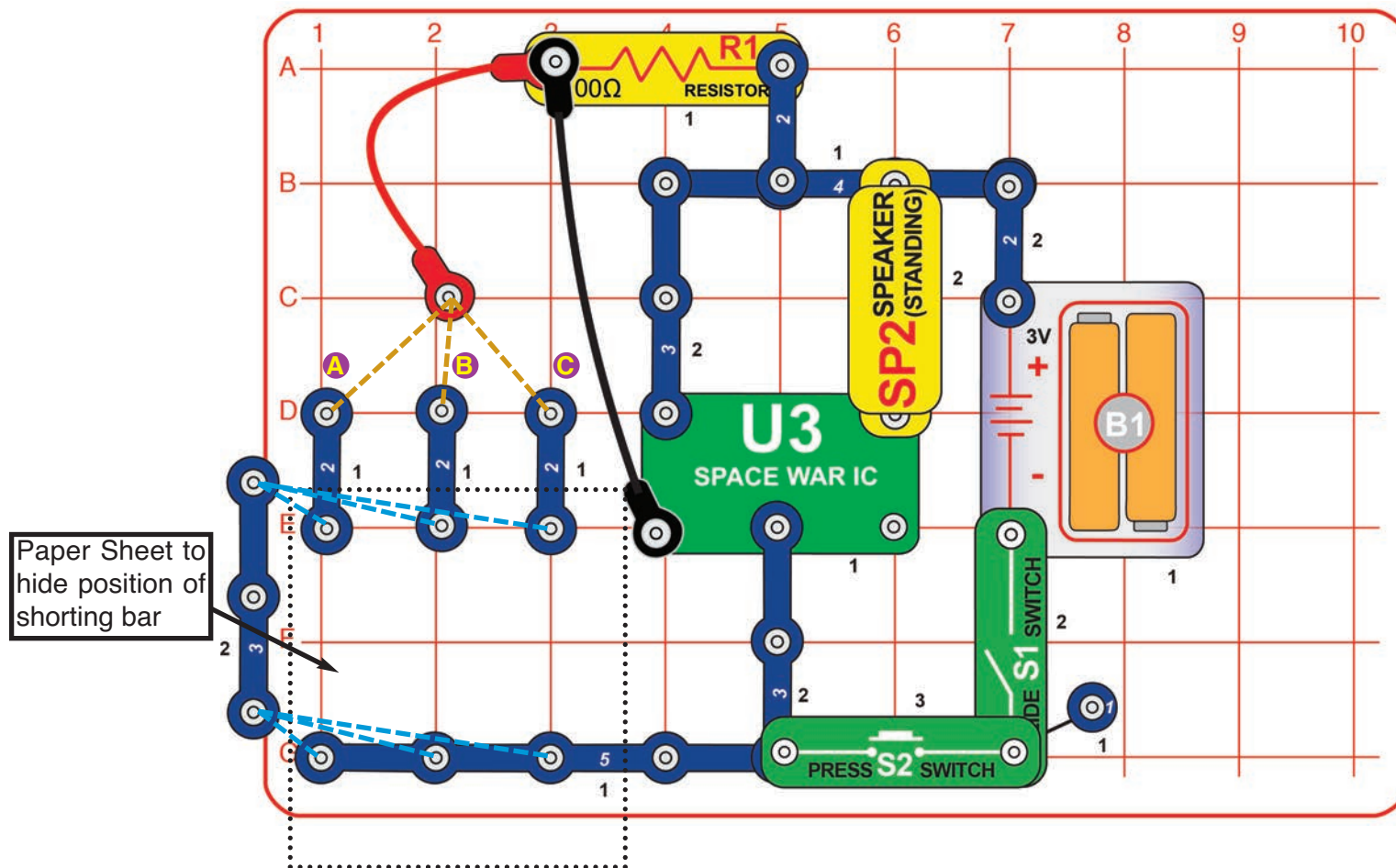

# Project 46

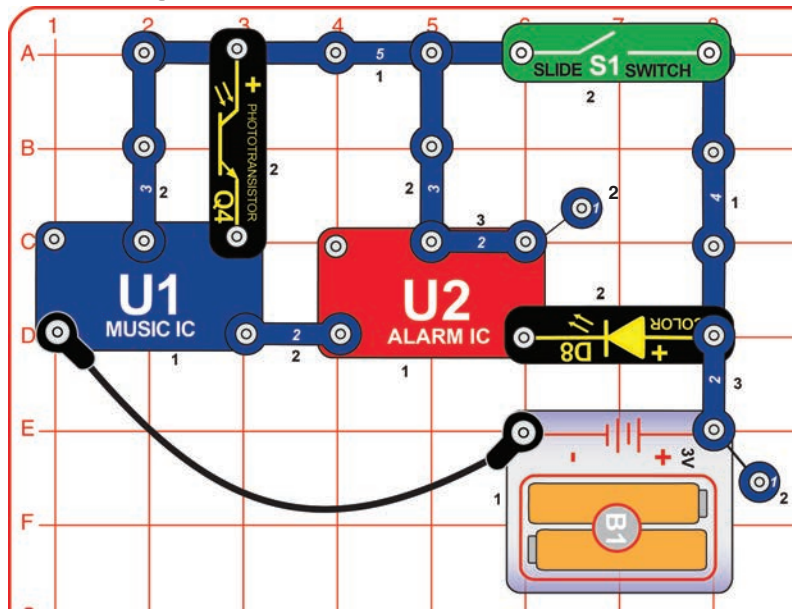

# Wave & Watch

This circuit does not use the noisy speaker (SP2) but instead uses a nice quiet color LED (D8). Turn on the slide switch (S1), the LED flickers. Wait a few seconds, and then cover the phototransistor (Q4), and the flicker stops. The flicker is controlled by the photoresistor; uncover it and the flicker resumes.



People that are deaf need lights to tell them when a doorbell is ringing. They also use circuits like this to tell them if an alarm has been triggered or an oven is ready. Can you think of other uses?

# Project 47

# Reflection Detector

Build the circuit to the right. Place it where there won't be any room light hitting the phototransistor (Q4) (such as in a dark room or under a table), and then turn it on. The 2.5V lamp (L1) will be bright, and one song may play, but then there should be no sound. Take a small mirror and hold it over the lamp and photoresistor. You should hear sound now. You have a music reflection detector! You can also use a white piece of paper instead of a mirror, since white surfaces reflect light.

Note: the motor (M1) will not spin. It is used here to block light from going directly from the lamp to the phototransistor.

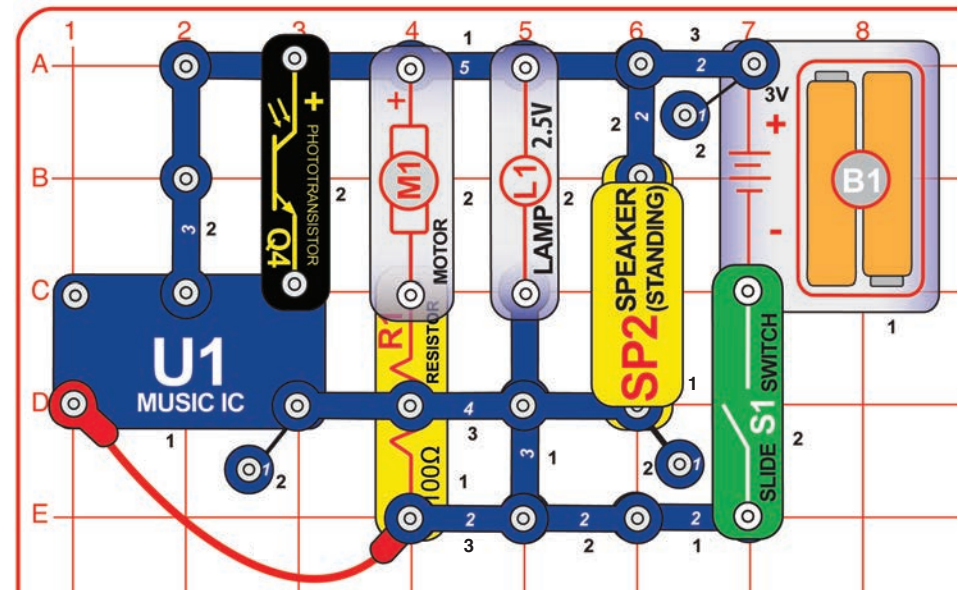

# Project 48

# Shine On Siren

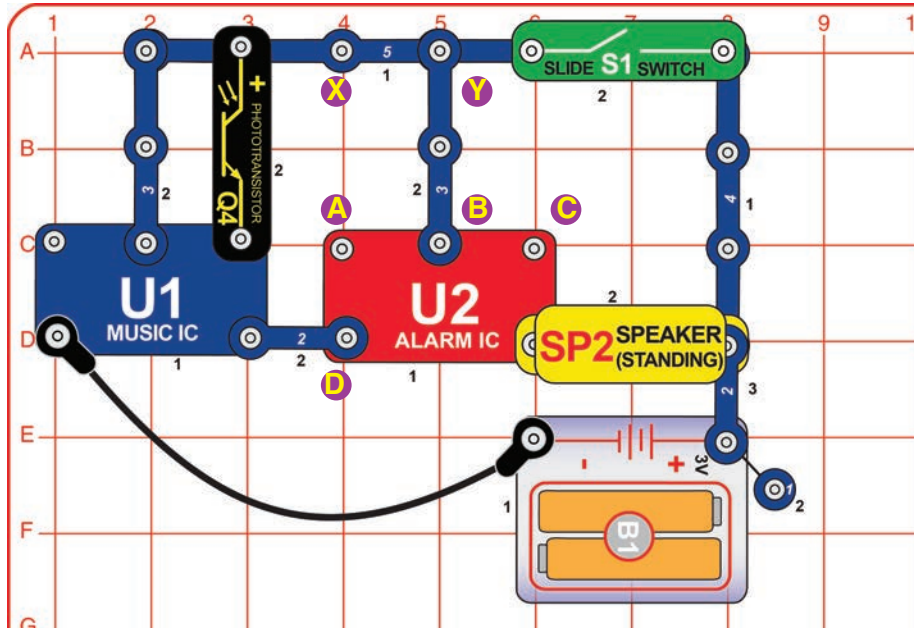

Cover the phototransistor (Q4) and turn on the switch (S1). A police siren is heard for a while and stops, then you can control it by covering or uncovering the photoresistor.

This circuit demonstrates how sounds can be synchronized to light patterns through the photoresistor.

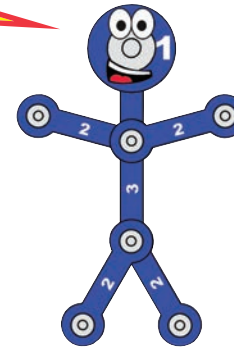

# Project 49 Shooting Sounds

Use the preceding circuit, but add a connection between the points marked B & C using a 1-snap and a 2-snap. Now it sounds like a machine gun.

# Project 50 Song & Siren

Use the preceding circuit, but remove the connection between B & C, and add a connection between A & B. Now it sounds like a fire engine

# Project 51 Ambulance Melody

Use the preceding circuit, but remove the connection between A & B, and add a connection between A & D. Now it sounds like a European siren.

# Project 52 Static Song

Now remove the connections between A & D and between Y & B, then make a connection between X & A. The circuit works the same way but now it sounds like a familiar song but with static.

# Project 53

# Mixed Up Music

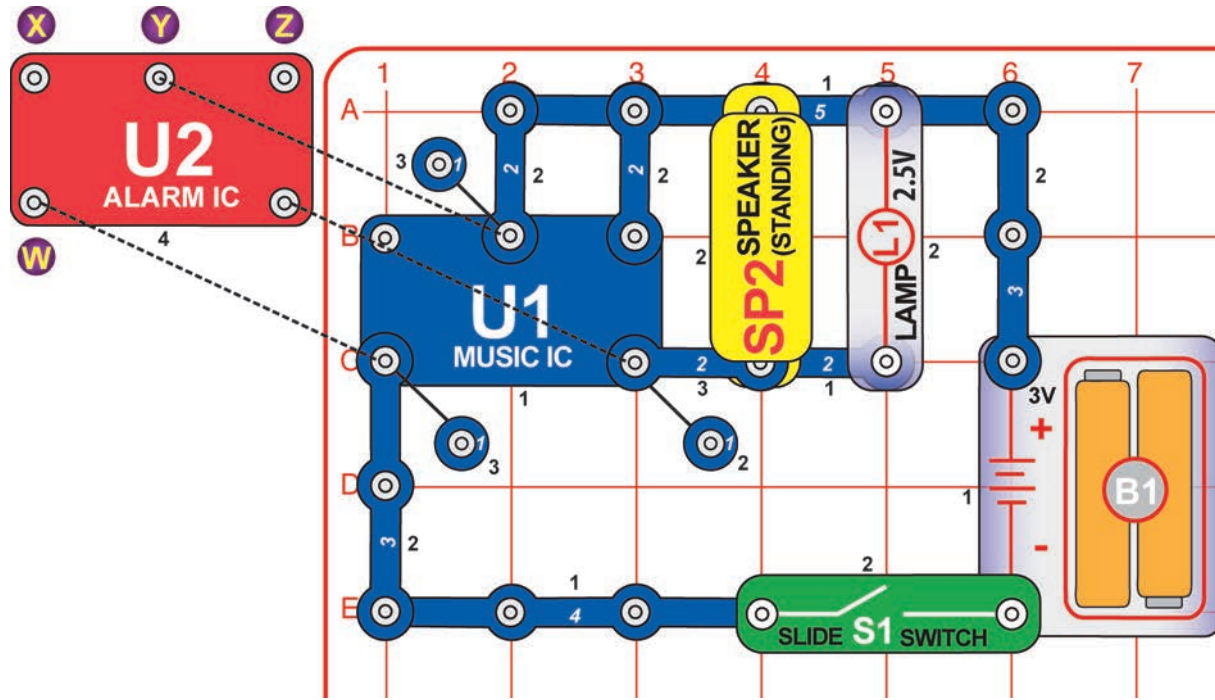

In the circuit, the outputs from the alarm and music ICs are connected together. Build the circuit shown and then place the alarm IC (U2) directly over the music IC (U1), resting on two 1-snaps and a 2-snap. Turn on the switch (S1) and you will hear a siren and music together while the lamp (L1) varies in brightness.

Snappy says there sure are a lot of different sounds that can be made with the music and alarm ICs.



# Project 54 Blaster Disaster

Modify the last circuit by connecting points Y & Z with a 2-snap (on level 5). The circuit works the same way but now it sounds like a machine gun with music.

# Project 55 Siren & Song

Now remove the 2-snap connection between Y & Z and then make a 2-snap connection between X & Y (on level 5). The circuit works the same way but now it sounds like a fire engine with music.

# Project 56 Ambulance Song

Now remove the 2-snap connection between X & Y and then make a 2-snap connection between W & X (on level 5). The circuit works the same way but now it sounds like an ambulance with music.

# Project 57 Space Battle

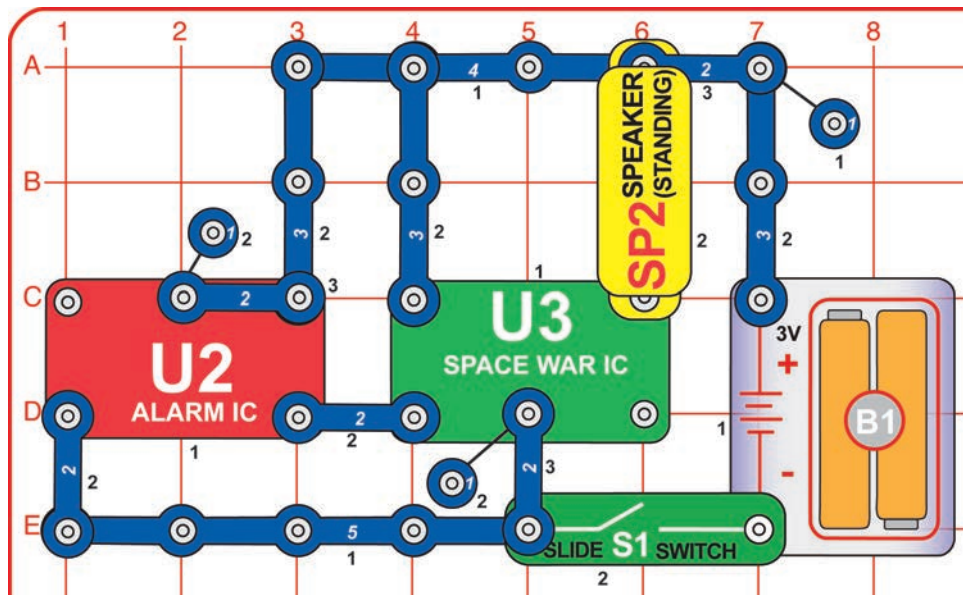

Build the circuit shown on the left. Turn on the switch (S1) and you will hear exciting sounds, as if a space battle is raging!

# Project 58 Bizarre Blinker

The preceding circuit is loud and may bother people around you, so replace the speaker (SP2) with the color LED (D8, "+" on top and away from U3).

# Project 59 Periodic Sounds

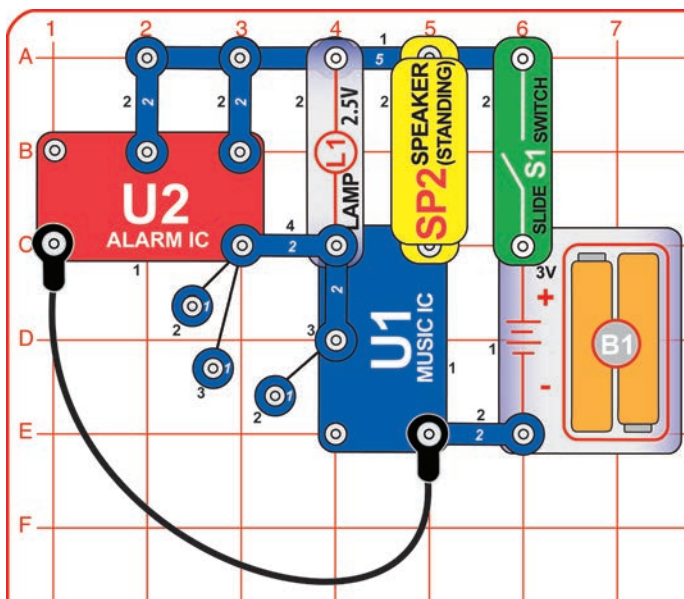

Build the circuit shown on the left and turn it on. The lamp (L1) alternates between being on and off while the speaker (SP2) alternates between two musical tones... like someone is flipping a switch, but at a very consistent rate. Periodic signals like this are very important in electronics.

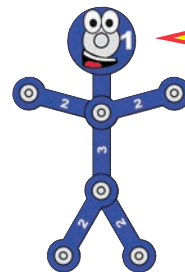

Periodic electrical signals are used for things like flashing yellow lights or sometimes in consumer devices to indicate batteries are low.

# Project 60 Blinking Double Flashlight

In the circuit at left, replace the speaker (SP2) with the color LED (D8). Make sure you connect the color LED with the positive (+) side on A5, not U1. The lamp (L1) alternates between being on and off while the color LED alternates between being dimmer and brighter.

# Project 61

# Motor-Controlled Sounds

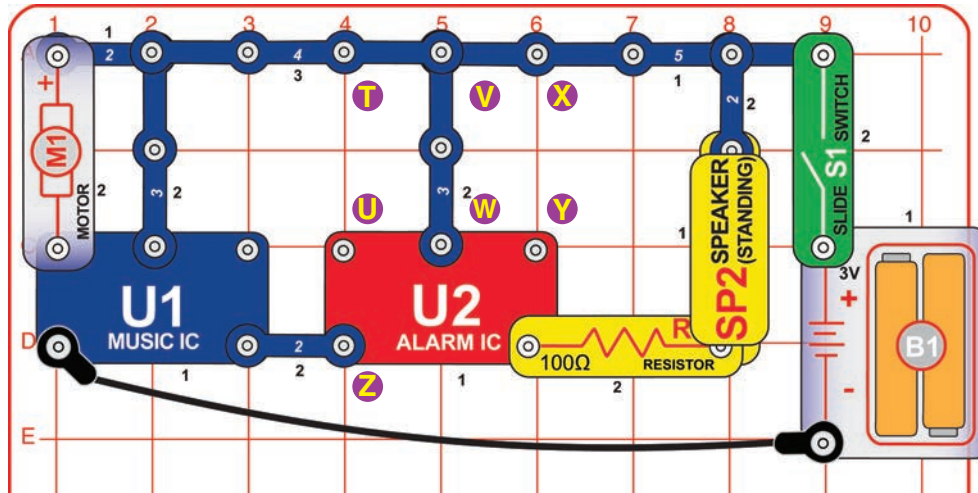

This circuit is controlled by spinning the motor (M1) with your hands. Turn on the switch. A police siren is heard and then stops. Spin the motor and it will play again. Note, however, that music can be heard faintly in the background of the siren.

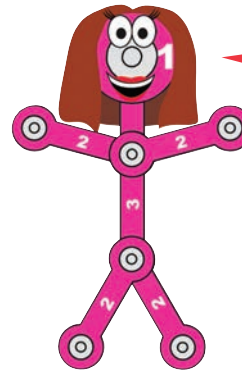

This project shows how a motor can be used to convert mechanical energy to electrical energy and sound. The speaker uses electromagnetism to create changes in air pressure, which your ears feel and interpret as sound. Think of the speaker as creating pressure waves in the air just like waves in a pool. You only see waves in the pool when you disturb the water, so the speaker only makes sound when the voltage changes.

## Project 62 Spin & Shoot

Modify the last circuit by connecting points X & Y with the 2.5V lamp (L1). The circuit works the same way but now it sounds like a machine gun.

## Project 63 Spin Out Siren

Now remove the connection between X & Y and then make a connection between T & U with the 2.5V lamp (L1). The circuit works the same way but now it sounds like a fire engine.

## Project 64 Whirl Out Warning

Now remove the connection between T & U and then make a connection between U & Z. The circuit works the same way but now it sounds like an ambulance.

## Project 65 Turn a Tune

Now remove the connections between U & Z and between V & W, then make a connection between T & U. The circuit works the same way but now it sounds like a familiar song but with static.

## Project 66

## Spinning Rings

**Setup:** Cut out the disc on page #52 that looks like the one shown here. Using Scotch tape, attach the disc with the printed side up on the top of the fan blade. Place the blade on the motor as shown to the left and below.

When the press switch (S2) is pressed, the arcs will turn into colored rings with a black background. Notice how the color drops in brightness when it is stretched to make a

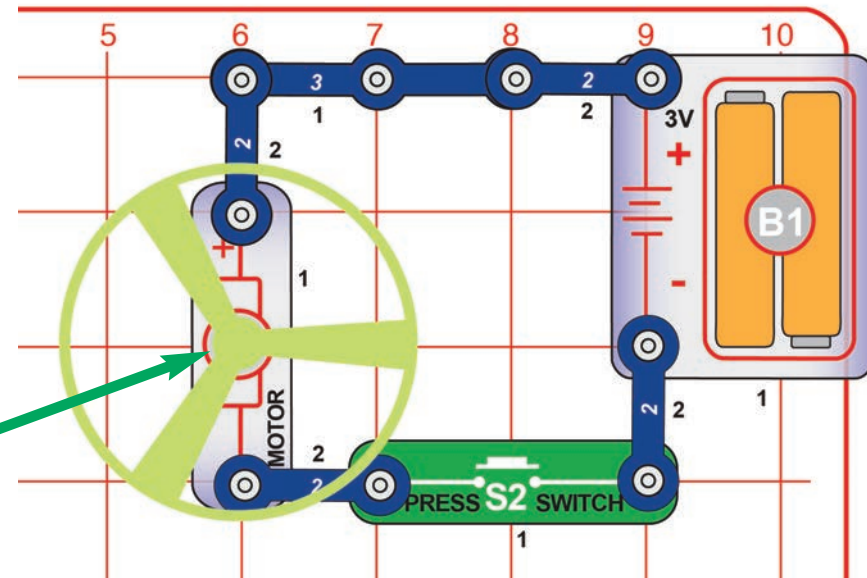

**WARNING:** Moving parts. Do not touch the fan or motor during operation.

## Project 67

## Strobe the House Lights

Place the spinning rings under a fluorescent light with a T12 bulb (1.5" diameter) that runs on normal house current. Start the disc spinning and release the press switch (S2). As the speed changes you will notice the white lines first seem to move in one direction then they start moving in another direction.



This effect is because the lights are blinking 120 times a second and the changing speed of the motor is acting like a strobe light to catch the motion at certain speeds. To prove this, try the same test with a flashlight. The light from a flashlight is constant and if all other lights are out, you will not see the effect that looks like a helicopter blade in a movie. This does not work with newer fluorescent lights, because they use an electronic ballast and produce a constant



# Project 68

Modify the preceding project by adding the pointer as shown on the left. The paper should be cut from page #52 and taped high enough on the speaker so the pointer will stick over the fan with paper. Bend the pointer at a right angle as shown on the left.

**Setup:** Cut out the grid with four (4) colors from page #52 and place it under the base as shown on the left. Each player picks a color (or two colors if only 2 people are playing) and places a single snap on row G. The purple player in column 1, the blue player in column 2, the green player in column 3, and the yellow player in column 4. Spin the wheel by closing the press switch (S2). The first single color wedge that the pointer points to is the first player to start. In some models you only have three 1-snaps, so use a 2-snap if you have four players.

**The Play:** Each player gets a turn to press the press switch. They release the press switch and when the pointer points to a wedge, the players that match the colors on the wedge get to move up one space. If a liner comes up like the one shown on the left then the players on each side of the line get to move up two (2) spaces. The first player to reach the top row (A) wins. If two players reach the top row at the same time they must both drop down to row "D" and play continues.

**WARNING:** Moving parts. Do not touch the fan or motor during operation.

# Race Game

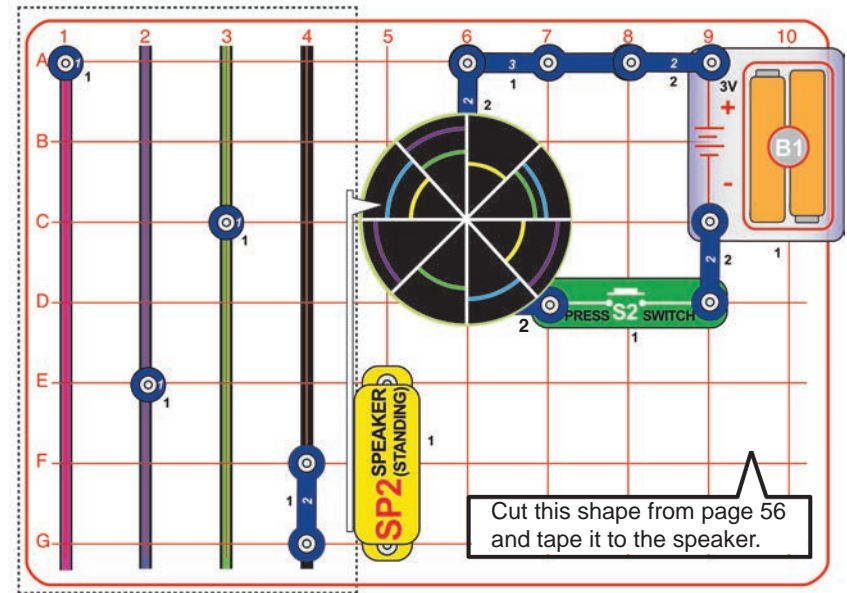

# Project 69

# Using Parts as Conductors

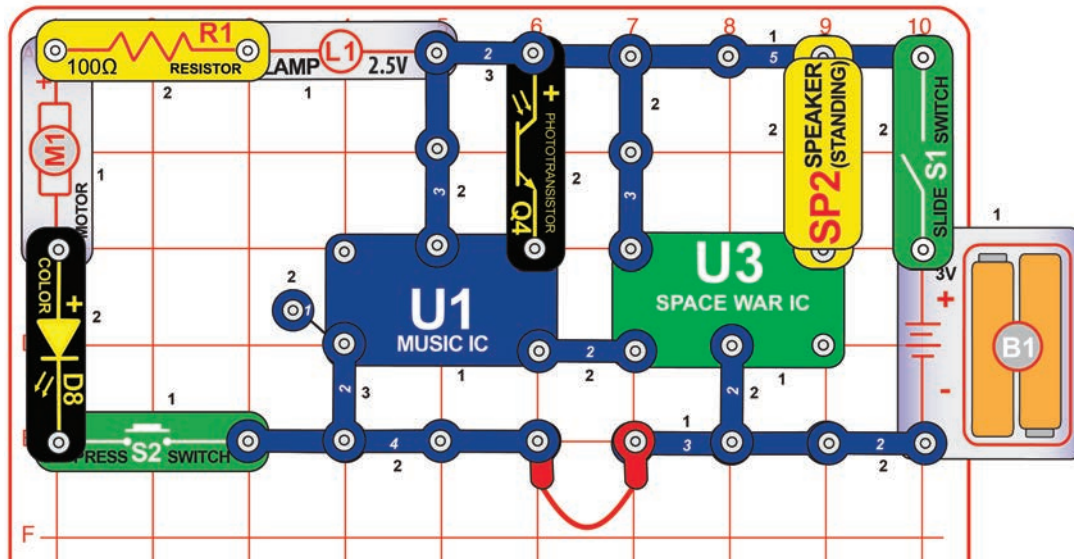

Turn on the slide switch (S1) and push the press switch (S2), you hear space war sounds. After a while the sound may stop, shine light on the phototransistor (Q4) to make the sound resume.



Note that the color LED (D8) lights, but the lamp (L1) does not light and the motor (M1) does not spin. Electricity is flowing through the lamp and motor, but not enough to turn them on. So in this circuit they are acting like 3-snap wires. You could replace D8 or L1 with a 3-snap and the circuit would work the same.

# Project 70

# Spin Draw

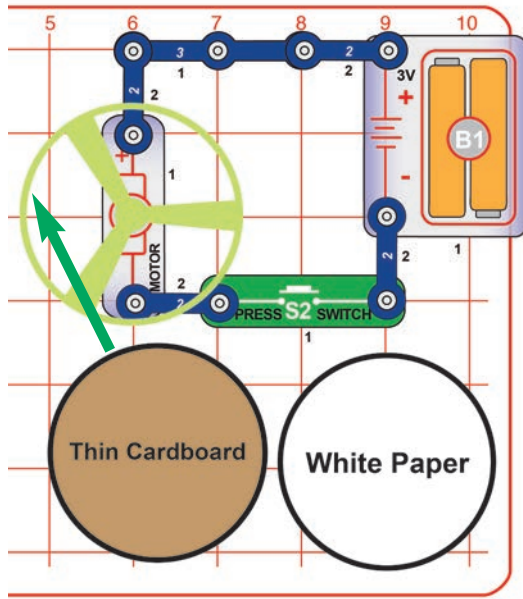

Rebuild the simple motor connection as shown on the left. This is the same setup as Project 66.

**Setup:** Cut out a circular piece of thin cardboard from the back of an old spiral notebook or note pad. Use the fan blade as a guide. Place the fan on the cardboard and trace around it with a pencil or pen. Cut the cardboard out with scissors and tape it to the fan blade. Do the same thing with a piece of white paper, but tape the paper on top of the cardboard so it can be removed easily later.

**Drawing:** To make a ring drawing obtain some thin and thick marking pens as drawing tools. Spin the paper by pressing and holding press switch (S2) down. Press the marker on the paper to form rings. To make spiral drawings, release press switch (S2) and as the motor approaches a slow speed move the marker from the inside outward quickly.

Change the colors often and avoid using too much black to get hypnotic effects. Another method is to make colorful shapes on the disc then spin the disc and watch them blend into each other. When certain speeds are reached under fluorescent lights without electronic ballasts, the strobe principle shown in another project will produce strange effects and backward movement. Make a wheel with different colored spokes to see this strange effect. Adding more spokes and removing spokes will give different effects at different motor speeds.

# Project 71

# Singing Motor

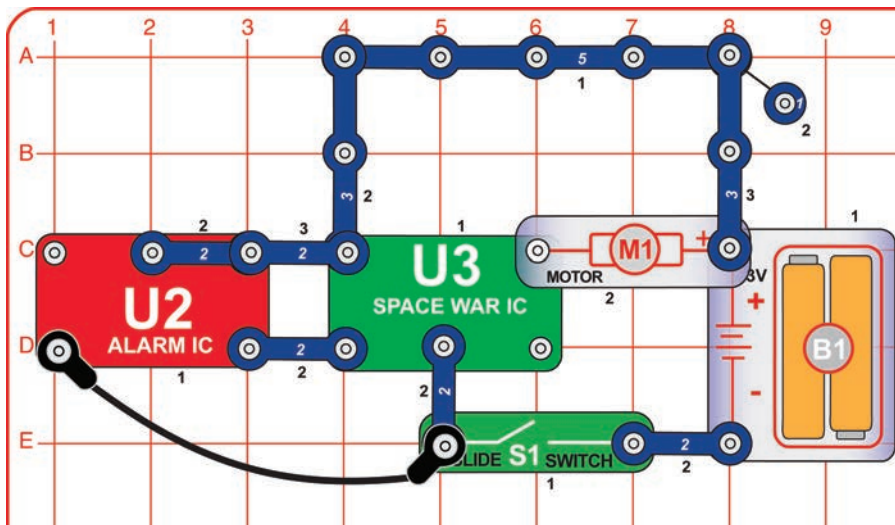

Turn on the switch and the motor spins (you may need to give it a push with your finger to get it started). The sounds from the IC are used to drive the motor. Because the motor uses magnets and a coil of wire similar to a speaker, you may even hear the space war sounds coming faintly from the motor.



The motor has a coil and a magnet similar to the speaker. An electrical signal in the coil creates a magnetic field, which makes the shaft spin. Normally the motor is used with a stable electrical signal, but in this project it is used with a changing signal from the space war IC. This creates mechanical vibrations, which create air pressure variations that sound like the speaker does, though not as efficiently.

# Project 72

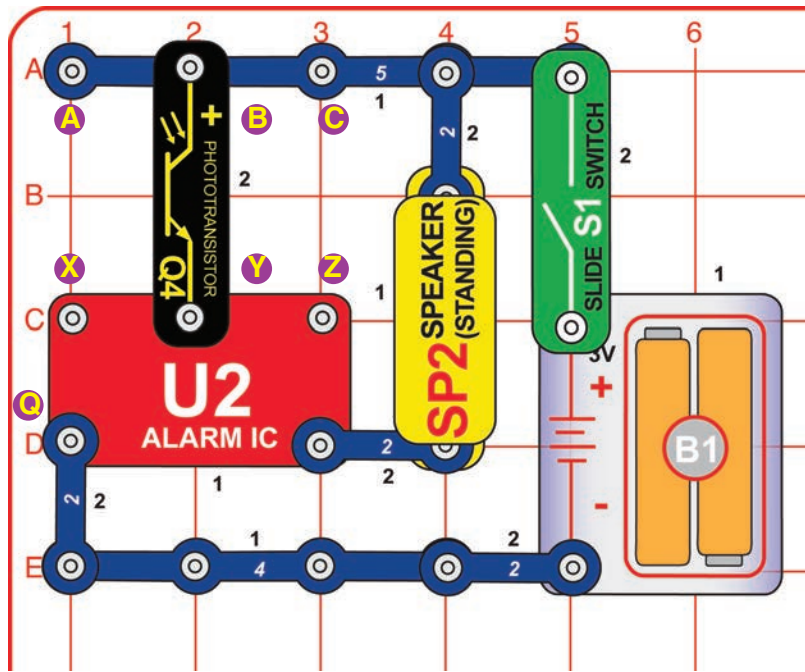

# Visual Volume

Build the circuit shown on the left.

Turn on the slide switch (S1), a police siren is heard. The loudness of the sound depends on how much light reaches the phototransistor (Q4). Try partially shielding it or placing near a very bright light, and compare the sound.

The phototransistor contains material that changes its resistance when it is exposed to light. As it gets more light, the resistance of the phototransistor decreases. Parts like this are used in a number of ways that affect our lives. For example, you may have streetlights in your neighborhood that turn on when it starts getting dark and turn off in the morning.

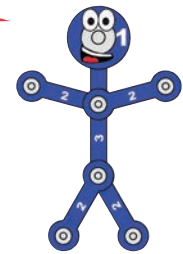

# Project 73 Eurosiren Volume

Modify the last circuit by connecting points X & Q using a 1-snap wire and a 2-snap wire. Now you hear a European siren when enough light reaches the phototransistor.

# Project 74 Funky Volume

Now remove the connection between points X & Q, and shift the phototransistor to points A & X. Now you hear a strange sound when enough light reaches the phototransistor.

# Project 75 Fire-Light Siren

Now add a 3-snap wire between B & Y. Now you hear a siren, which changes to a fire engine sound when enough light reaches the phototransistor.

# Project 76 Crooks & Cars

Now shift the phototransistor to points C & Z, Now depending on how much light reaches the phototransistor, you will hear either a police siren or

# Project 77 Static Gun

Now shift the 3-snap wire from points B & Y to points A & X. The circuit works the same way but now depending on how much light reaches the phototransistor you will hear either a machine gun sound or a different sound.

# Project 78

# Pop On, Pop Off

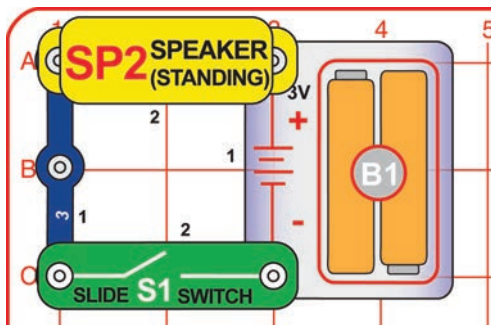

Turn the slide switch (S1) on and off several times. You hear static from the speaker (SP2) when you turn the switch on or off.

The speaker uses electromagnetism to create changes in air pressure, which your ears feel and interpret as sound. Think of the speaker as creating pressure waves in the air just like waves in a pool. You only see waves in the pool when you disturb the water, so the speaker only makes sound when the voltage changes.

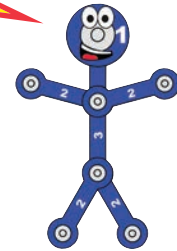

# Project 79 Crazy Combo

# Project 80 Alien Alarm

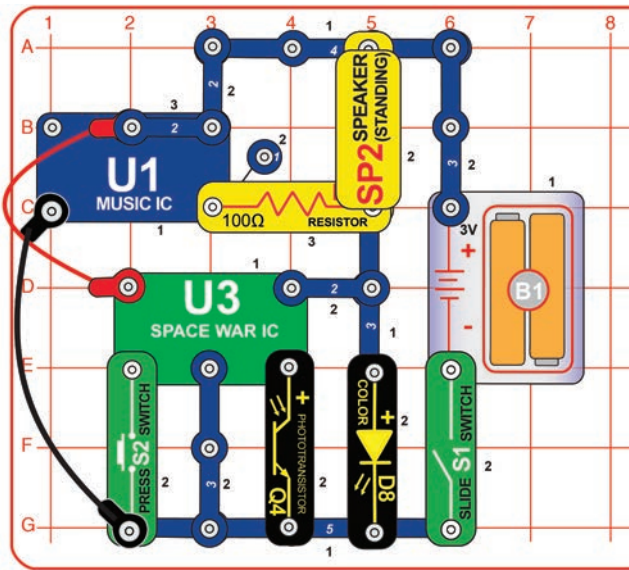

Build the circuit shown. Turn it on, press the press switch (S2) several times, and wave your hand over the phototransistor to hear all the sound combinations. You can make the sound from the music IC louder by replacing the 100Ω resistor (R1) with the 2.5V lamp (L1).

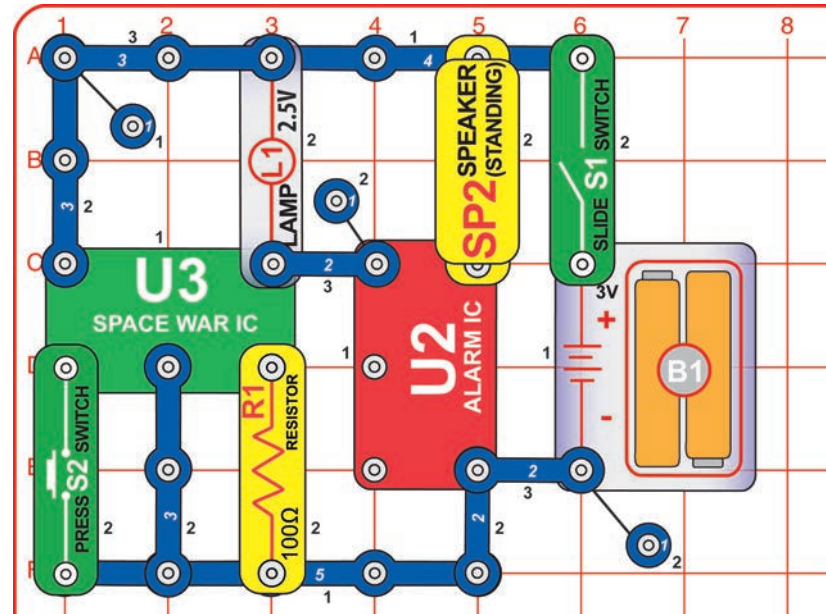

Build the circuit shown on the left and turn on the slide switch (S1). Press and hold the press switch (S2) to make the lamp (L1) brighter.

# Project 81

# Two-way Light Switch

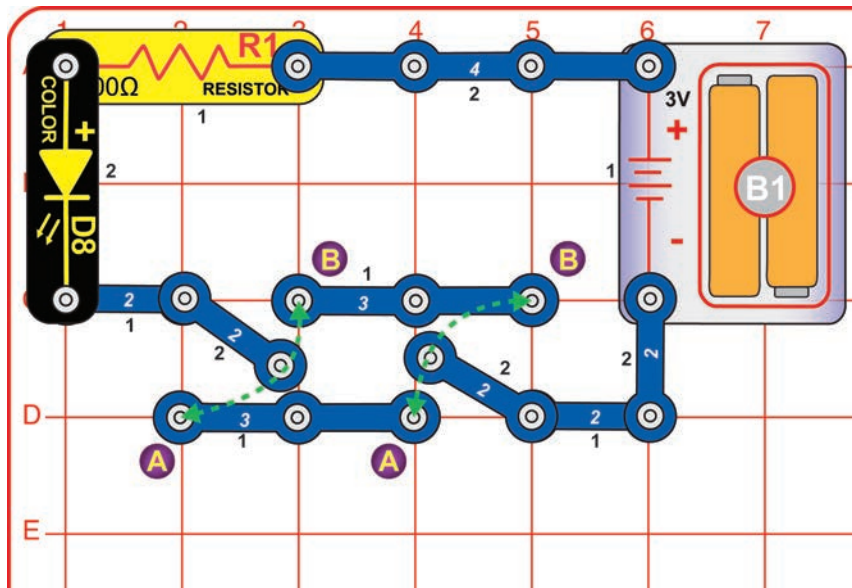

Build the circuit on the left. Note that two of the 2-snaps are left unconnected on one end because they will be used as switches in this project. If you connect the free ends of each of these 2-snaps both to the “high bar” or positions B in the figure or both to the “low bar” or positions A in the figure, the color LED (D8) lights up. But if you connect the free end of one of the 2-snaps to the “high bar” and the free end of the other 2-snap to the “low bar”, then the color LED does not light up.

# Project 82

# Machine Gun Buzz

# Project 83 Double Flash Machine Gun

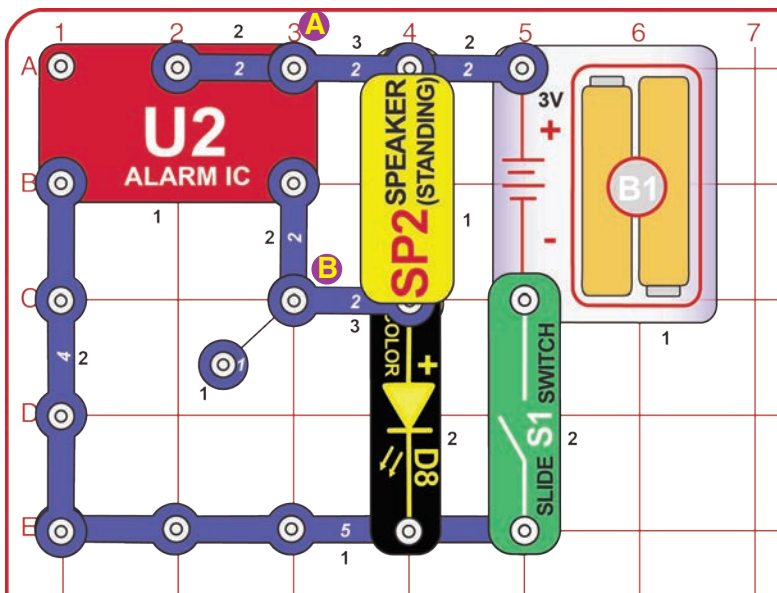

Build the circuit shown on the left. Turn on the switch (S1) and you hear a machine gun and a buzzing sound, while the color LED (D8) is changing

Use the preceding circuit, but add the lamp (L1) across the points marked A & B, on level 4.

# Project 84

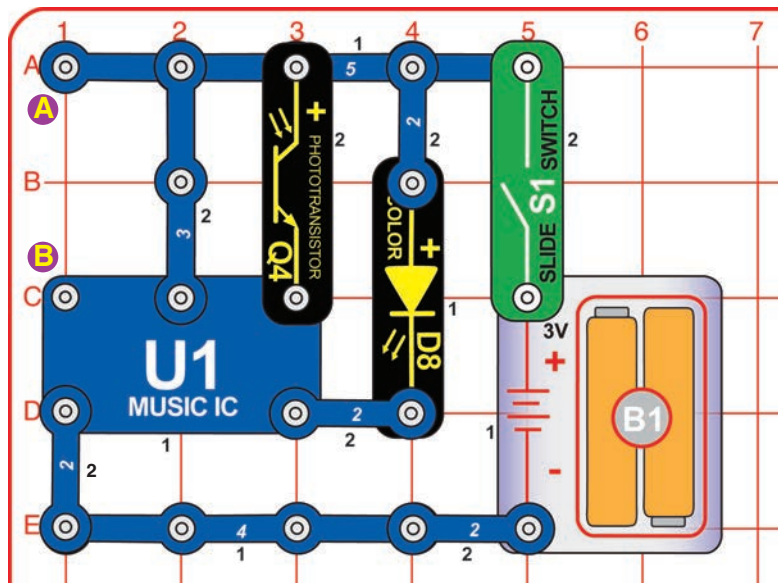

Build the circuit to the left. Cover the phototransistor (Q4), turn the switch on, and notice that the color LED (D8) is on for several seconds and then goes off. Uncover the photoresistor and place the unit near a light and the LED will light. Cover the phototransistor again and the LED will turn off. The resistance of the photoresistor decreases as the light increases activating the U1 IC that varies the voltage to the LED making it light.

# Project 85 Go & Glow

Use the preceding circuit, but connect the motor (M1) across points A and B on the base grid, and remove the phototransistor (Q4). Turn the switch on and the color LED (D8) lights for several seconds then goes out. Turn the shaft of the motor and the LED will light again. As the motor turns, it produce a voltage. There is a magnet and a coil inside the motor. When the axis turns the magnetic field will change and generate a small current through its terminals. This voltage then activates the music IC.

# Project 86

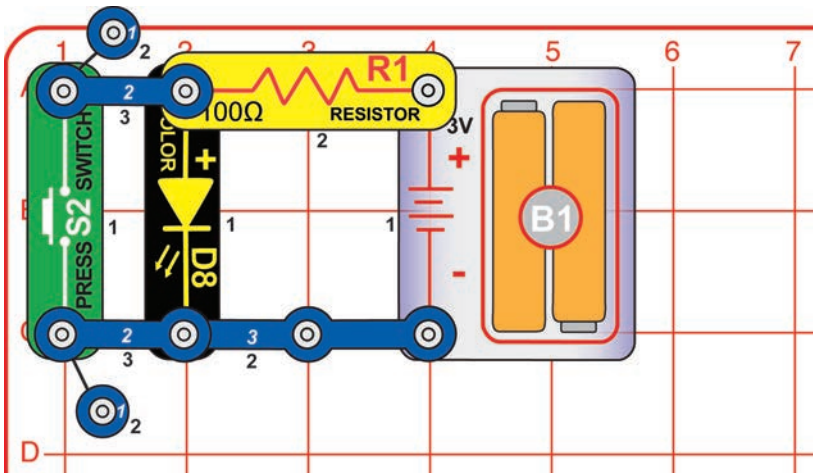

Build the circuit shown. Notice that when the press switch (S2) is pressed, the color LED (D8) goes off. This is an example of an inverter circuit, or NOT gate. Whenever the input is high (switch is on), the output is low (LED is off) and whenever the input is low (switch is off) the output is high (LED is on). Disassemble the circuit when finished to avoid draining your batteries.



Although this circuit seems simple, inverters or NOT gates are very important in digital logic circuits.

# Project 87

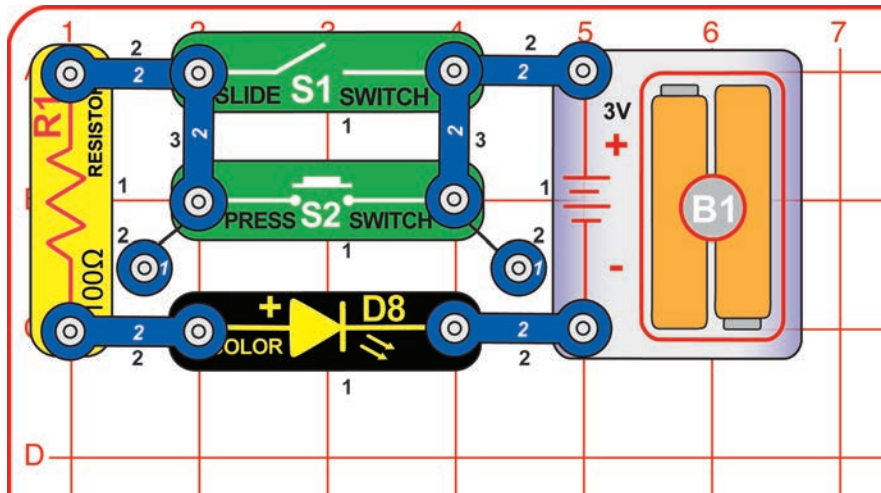

# This OR That

Build the circuit shown. Notice that if you turn on the slide switch (S1) OR press the press switch (S2) the color LED (D8) lights up. There is no partially lit state here, the diode is either totally on or totally off. While this may seem very simple and boring, it represents an important concept in electronics. Two switches like this may be used to turn on a light in your house, or they might be two sensors at a railroad crossing used to start the ding-ding sound and lower the gate. You could also have more than two switches and the circuit would function the same

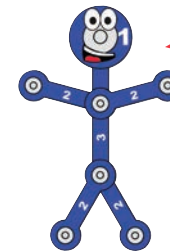

This circuit is commonly called an OR gate. OR gates are used in digital logic circuits to perform logical additions. When one of the inputs is high (one of the switches is on) the output is high (LED on). The output will only be low (LED off) if both inputs are low (both switches are off).

# Project 88

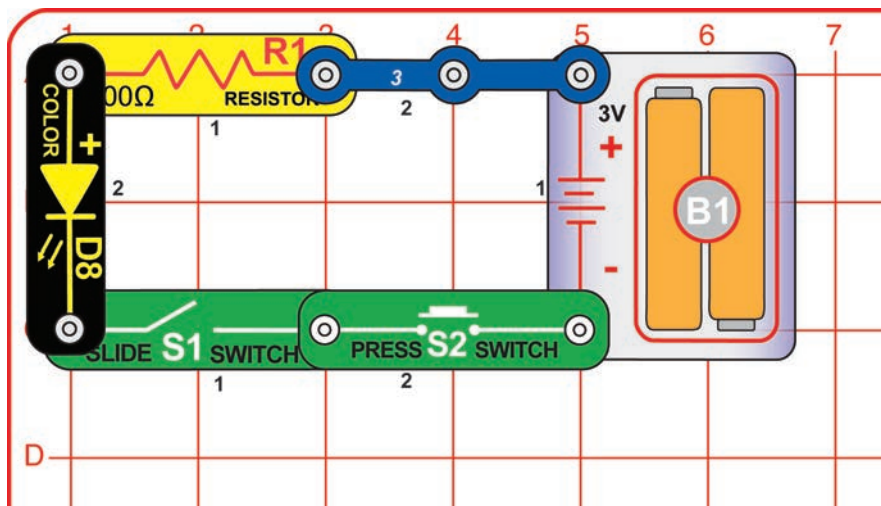

# This AND That

Build the circuit shown. Notice that if you turn on the slide switch (S1) AND press the press switch (S2) the color LED (D8) lights up. Once again, there is no partially lit state here, the LED is either totally on or totally off. Two switches like this may be used to turn on the same light in your house, the room switch and the master switch in the electrical box. You could also have more than two switches and the circuit would function the same way.



This circuit is commonly called an AND gate. AND gates are used in digital logic circuits to perform logical multiplies. When one of the inputs is low (one of the switches is off) the output is low (LED off). The output will only be high (LED on) if both inputs are high (both switches are on). Combinations of AND and OR circuits are used to add and multiply numbers together in modern computers. These circuits are made of tiny transistors in massive integrated circuits.

## Project 89

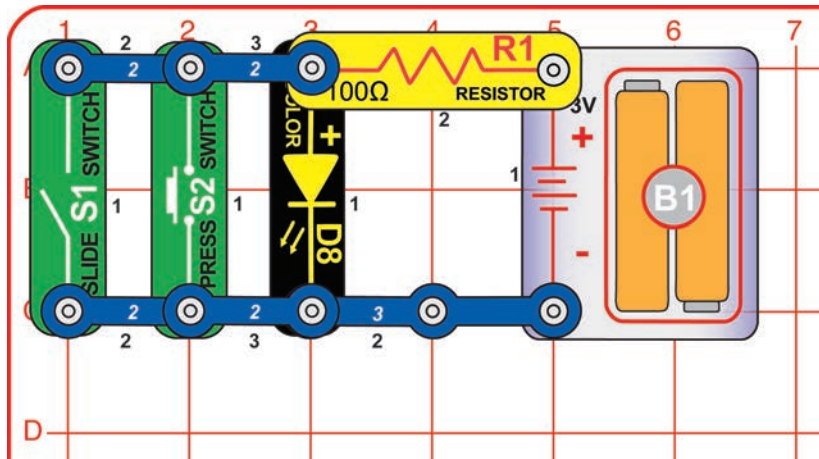

## Neither This NOR That

Build the circuit at left and test the combinations of the slide switch (S1) and press switch (S2). If you compare it to the OR circuit in Project #82, you can see the color LED (D8) lights in the opposite combinations of that circuit. Hence, we refer to it as a **NOR** circuit (short for “NOT this OR that”). Like the OR and AND, it is an important building block in computers.

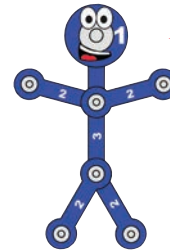

This circuit is commonly called a NOR gate. NOR gates are used in digital logic circuits to perform an inverted logical add. When one of the inputs is high (one of the switches is on) the output is low (LED off). The output will only be high (LED on) if both inputs are low (both switches are off).

## Project 90

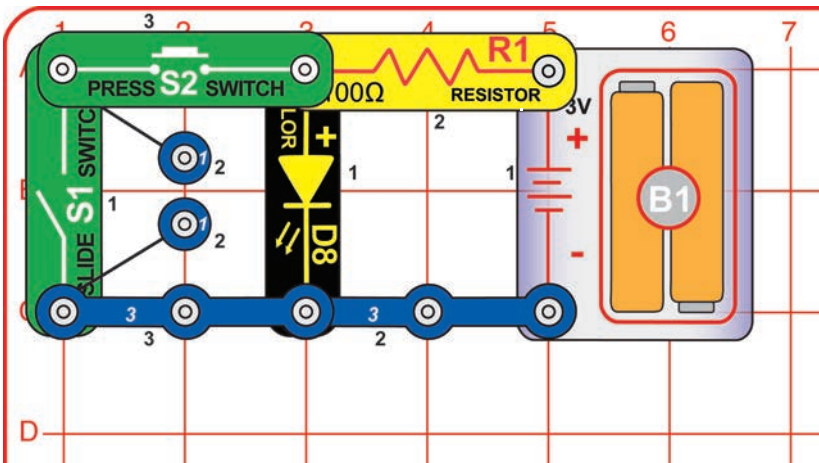

## NOT This AND That

Build the circuit at left and test the combinations of the slide switch (S1) and press switch (S2). If you compare it to the AND circuit in Project #83, you can see the color LED (D8) lights in the opposite combinations of that circuit. Hence, we refer to it as a **NAND** circuit (short for “NOT this AND that”). This circuit can also have more or less than two inputs, though when it only has one input it is referred to as a **NOT** circuit. Like the OR, AND, and NOR, NAND and NOT are important building blocks in computers.



This circuit is commonly called a NAND gate. NAND gates are used in digital logic circuits to perform an inverted logical multiply. When one of the inputs is low (one of the switches is off) the output is high (LED on). The output will only be low (LED off) if both inputs are high (both switches are on).





# Project 91 Music AND Gate

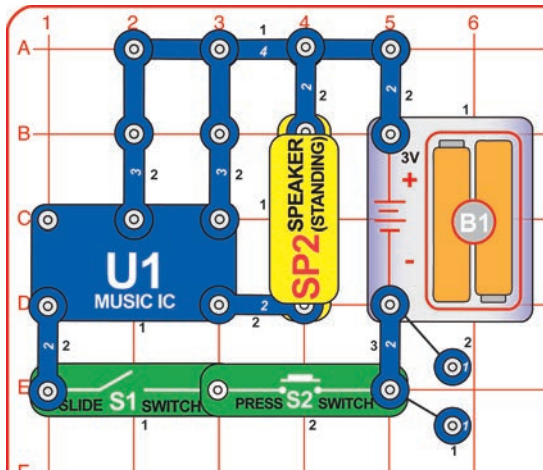

You will only hear music if you turn on the slide switch (S1) **AND** press the press switch (S2). This is referred to as an AND gate in electronics. This concept is important in computer logic.

**Example:** If condition X **AND** condition Y are true, then execute instruction Z.



# Project 92 Touch & Go

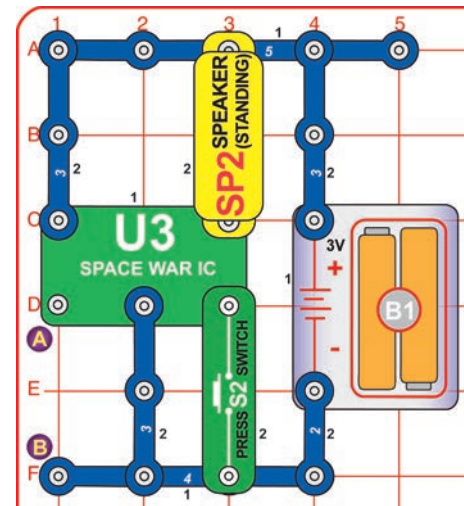

Wet your fingers with some water or saliva and touch them across points A and B several times to hear some space war sounds. Push the press switch (S2) to hear more sounds at the same time.

This circuit uses your body to conduct electricity, and turn on the circuit. Wetting your fingers improves the connection between the metal and your finger.



# Project 93

# Flash & Tone

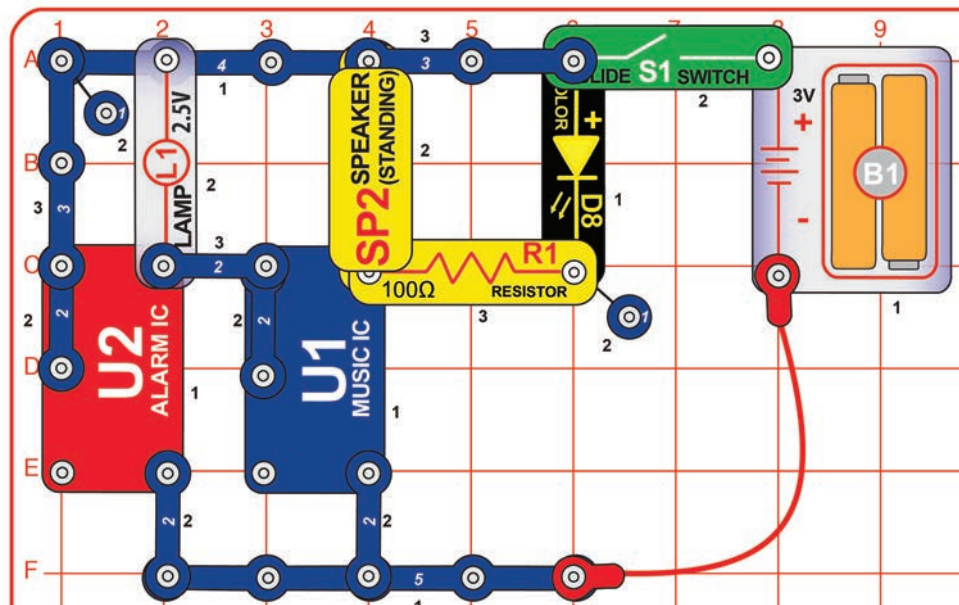

Turn the switch (S1) on and the lamp (L1) and color LED (D8) start flashing. You hear two different tones driving the LED and lamp. ICs can be connected to control many different devices at the same time.

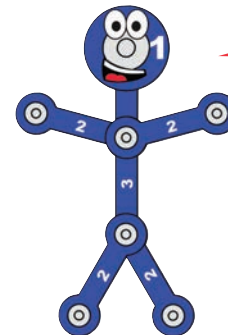

Connecting the output of the Alarm or Music ICs to multiple devices (such as the LED, speaker and lamp) enables these devices operations to be synchronized.

# Project 94

# Fan Flash Energy

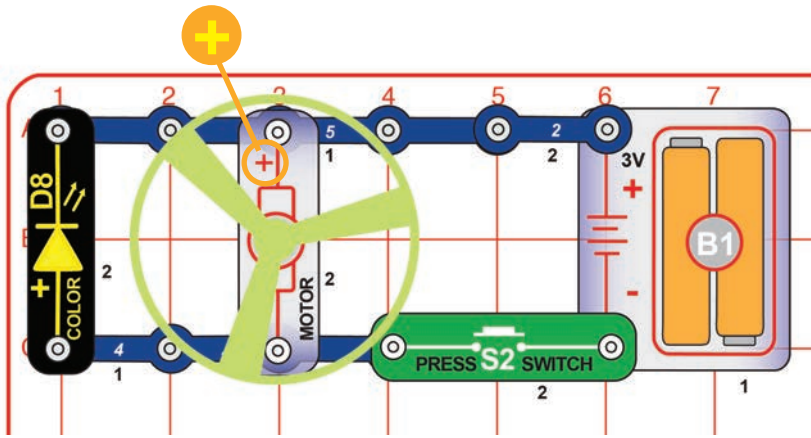

Place the fan on the motor (M1). Hold down the press switch (S2) for a few seconds and then watch the color LED (D8) as you release the switch. The LED flashes briefly but only after the batteries (B1) are disconnected from the circuit.

Do you know why the LED flashes? It flashes because the motor uses a magnetic field to spin the shaft. When the switch is released energy creates a brief current through the LED.

If you reverse the motor direction, then the LED will light the same way, but the fan may fly off after the LED lights.

**WARNING:** Moving parts. Do not touch the fan or motor during operation. Do not lean over the motor.

# Project 95

# Fun with the Alarm IC

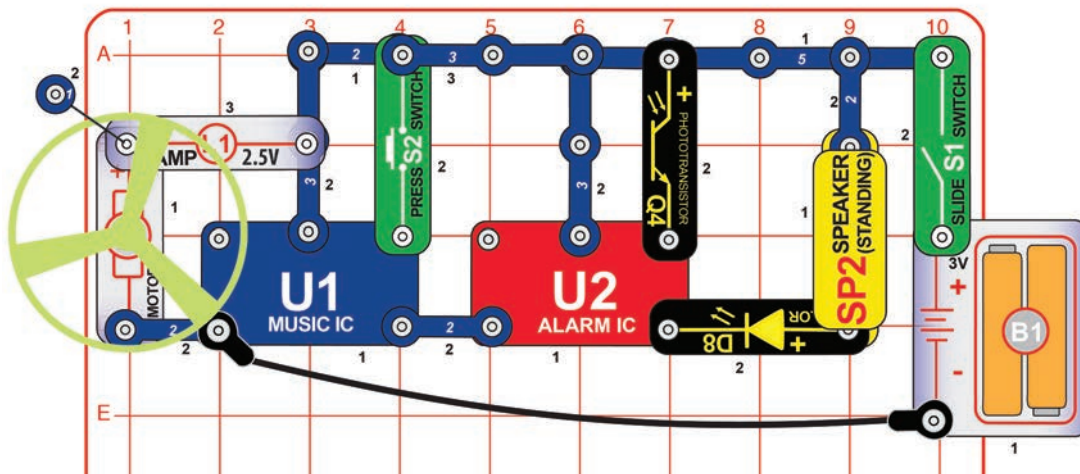

Place the fan on the motor (M1) and turn on the slide switch (S1). The lamp (L1) lights, the motor spins, and you hear a machine gun sound (with very faint music in background). Cover the phototransistor (Q4) with your hand and the sound becomes a siren. After a while the sound will stop, hold down the press switch (S2) and the sound resumes.

Phototransistors can be used to control many devices such as street lights, clock radio alarms, night lights, etc.

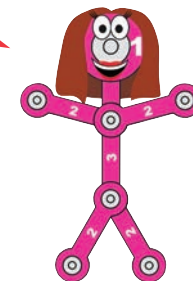

**WARNING:** Moving parts. Do not touch the fan or motor during operation. Do not lean over the motor.

## Project 96 Music Alarm Combo

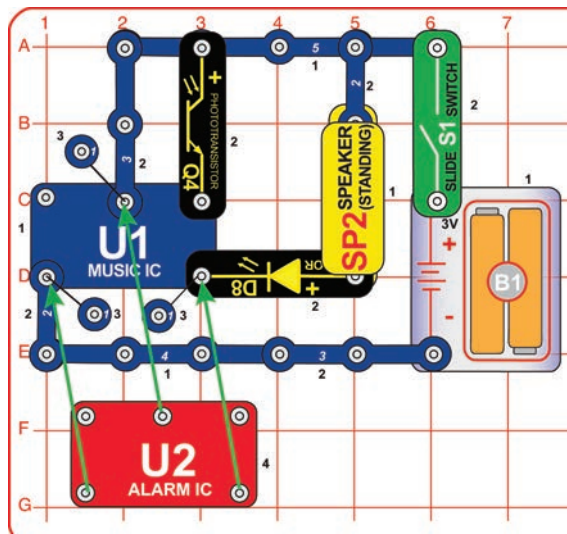

Build the circuit shown and then place the alarm IC (U2) directly over the music IC (U1), resting on the three 1-snaps. Turn on the slide switch (S1) and you will hear a siren and music together. After a few seconds, covering the phototransistor (Q4) will stop the music (but the siren continues).

## Project 97 Hit the Target

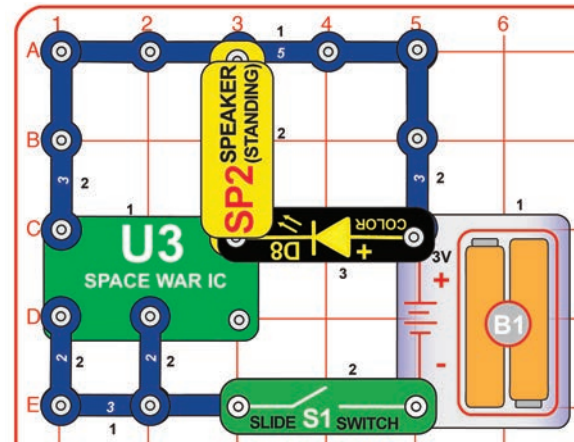

Turn the slide switch (S1) on and you hear the sound of a bomb dropping and then exploding. The color LED (D8) lights and then flashes as the bomb explodes. This is one sound generated from the space war IC (U3).

## Project 98 Water Space War

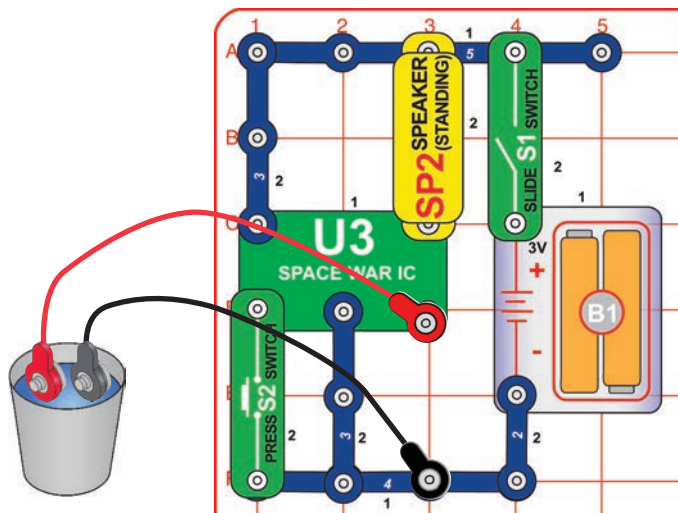

Build the circuit shown, including the jumper wires going between it and the cup of water shown. There will be sound when you push the press switch (S2) or when the jumper wires are in the water. Pushing the press switch or placing the jumper wires out and then back in into the water will change the sound played.

## Project 99 Light/Water Space War

Use the preceding circuit. Replace the speaker (SP2) with the color LED (D8, "+" to top). Putting the jumper wires in the water OR pressing the press switch (S2) will cause the LED to be bright.

## Project 100 OR/AND Space War Light

Use the preceding circuit. Replace the color LED (D8) with the 2.5V lamp (L1). Putting the jumper wires in the water OR pressing the press switch (S2) will cause the lamp to be dimly lit. Putting the jumper wires in the water AND pressing the press switch at the same time will cause the lamp to be much brighter.

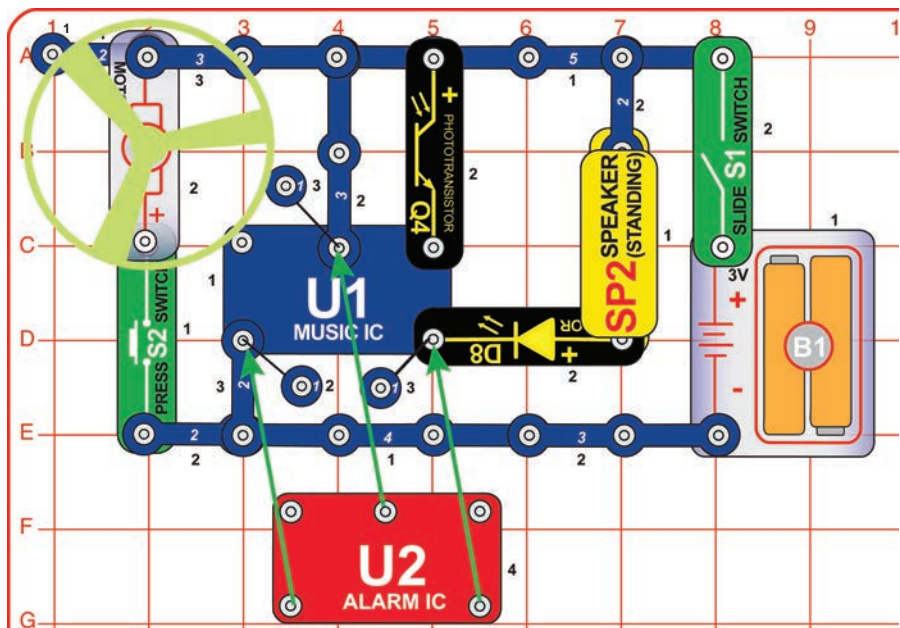

## Project 101 Sing & Fling

In the circuit, the outputs from the alarm (U2) and music ICs are connected together. Build the circuit shown and then place the alarm IC (U2) directly over the music IC (U1), resting on two 1-snaps and a 2-snap. Turn on the slide switch (S1) and you will hear a siren and music together. Push the press switch (S2) and the fan spins, while the sound may not be as loud. The fan may rise into the air when you release the switch. If the sound stops, shine light on the phototransistor (Q4).

**WARNING:** Moving parts. Do not touch the fan or motor during operation. Do not lean over the motor. Fan may not rise until switch is released.

## Project 102 Power Pitch

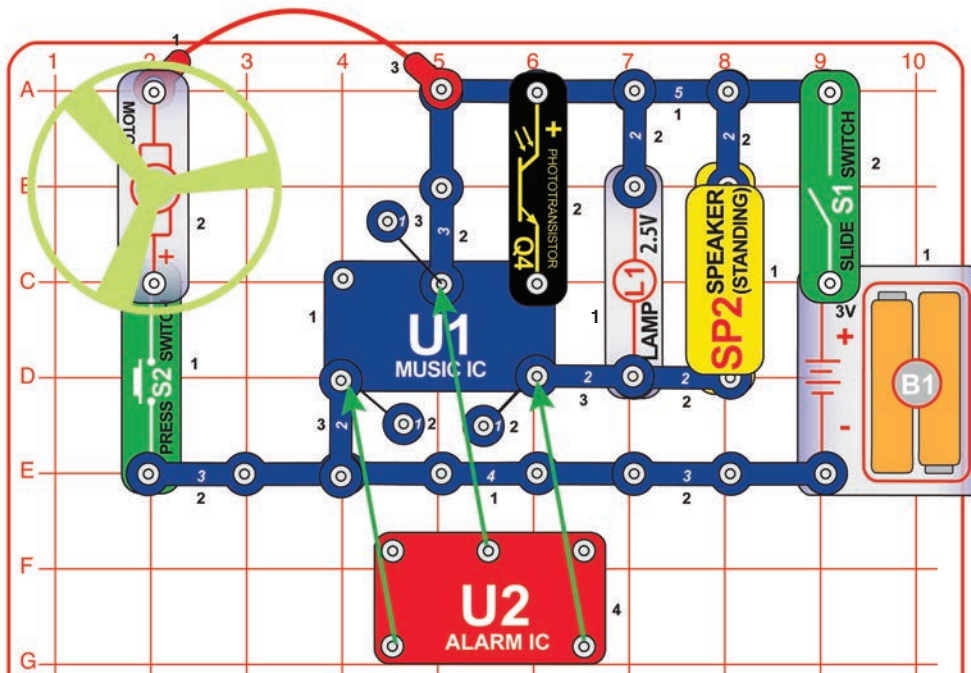

In the circuit, the outputs from the alarm and music ICs are connected together. Build the circuit shown and then place the alarm IC (U2) directly over the music IC (U1), resting on two 1-snaps and a 2-snap. Turn on the slide switch (S1) and you will hear a siren and music together while the lamp (L1) varies in brightness. Push the press switch (S2) and the fan spins, while the sound may not be as loud. The fan may rise into the air when you release the switch.

You can replace the lamp with the color LED (D8, "+" on top). The sound will be louder than in the preceding circuit.

**WARNING:** Moving parts. Do not touch the fan or motor during operation. Do not lean over the motor. Fan may not rise until switch is released.

# □ Project 103

# Morse Code

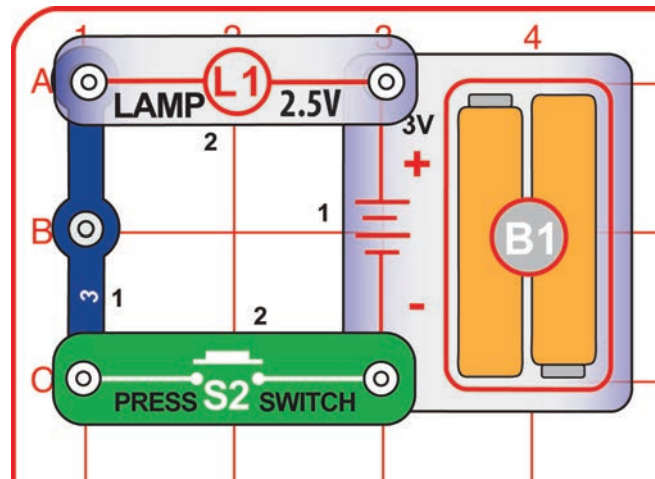

This simple circuit can be used for communication. Press the press switch (S2) in long and short bursts to make a pattern of light flashes representing the dots and dashes shown in the Morse Code table below. You can use Morse Code and this circuit to send secret messages to some friends in the room without others knowing what you're saying.

If you have a strong flashlight or searchlight then you can send messages to friends far away at night. During World War II Navy ships sometimes communicated by flashing Morse Code messages between ships using searchlights (because radio transmissions might reveal their presence to the enemy).

Years ago Indians would send messages to other tribes using smoke signals and a special code.

**Morse Code:** The forerunner of today's telephone system was the telegraph, which was widely used in the latter half of the 19th century. It only had two states - on or off (that is, transmitting or not transmitting), and could not send the range of frequencies contained in human voices or music. A code was developed to send information over long distances using this system and a sequence of dots and dashes (short or long transmit bursts). It was named Morse Code after its inventor. It was also used extensively in the early days of radio communications, though it isn't in wide use today. It is sometimes referred to in Hollywood movies, especially Westerns. Modern fiber optics communications systems send data across the country using similar coding systems, but at much higher speeds.

MORSE CODE			
A	· _	N	_ ·
B	····	O	___
C	····	P	· _ _ ·
D	·· _	Q	·· _ _
E	·	R	· _ ·
F	····	S	·· ·
G	·· _	T	_
H	····	U	·· _
I	· ·	V	·· · _
J	· _ _ _	W	· _ _
K	_ · _	X	_ · · _
L	· · ·	Y	_ · _ _
M	_ _	Z	_ _ ·
		Period	· · · · ·
		Comma	· · · ·
		Question	· · · · ·
		1	· _ _ _
		2	· _ _
		3	· _
		4	·
		5	· · · ·
		6	· · ·
		7	· ·
		8	·
		9	· · ·
		0	· · · ·

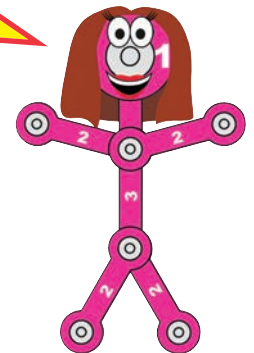

## Project 104 Motor Space Sounds

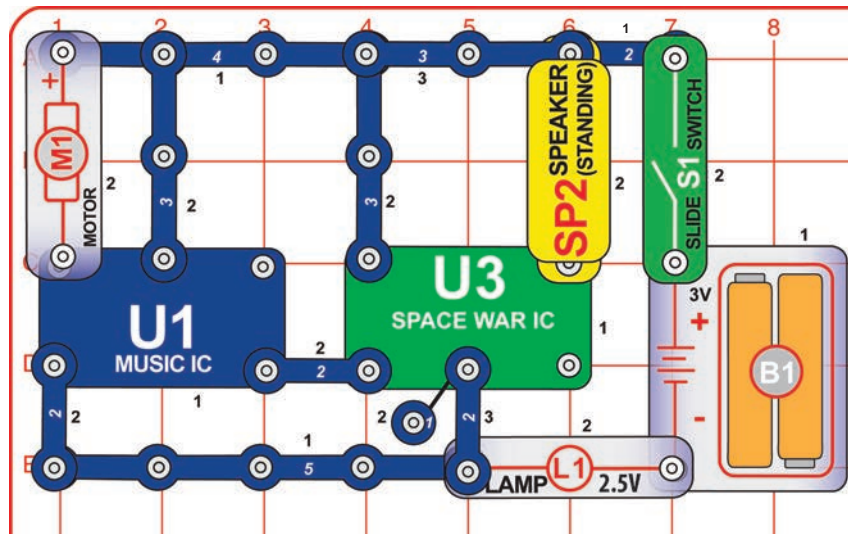

Turn it on and wait for any sounds to stop. Then, spin the motor (M1) and the sounds play again.

Do you know why turning the motor makes the sound play? Actually, the DC motor is also a DC generator and when you turn it, the motor generates a voltage that triggers the sound circuits.

The lamp (L1) is used here as a 3-snap wire, and will not light.

## Project 105 Twist & Blink

This circuit is loud and may bother other people around you so replace the speaker (SP2) with the color LED (D8), (“+” side on top); the circuit operates in the same manner but now the color LED flashes instead of the speaker making sounds.

## Project 106

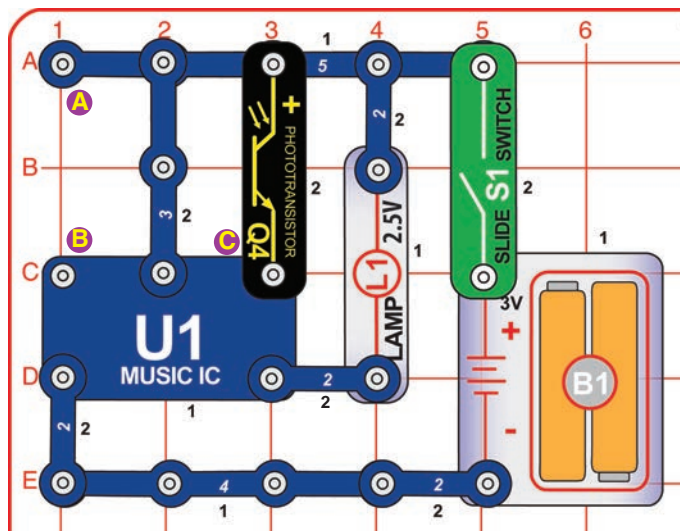

Build the circuit to the left. Cover the phototransistor (Q4), turn the slide switch (S1) on, and notice that the lamp (L1) is off after several seconds. Place the unit near a light and the lamp turns on. Cover the phototransistor again. The lamp turns off. The resistance of the phototransistor decreases as the light increases. The low resistance acts like a wire connecting point C to the positive (+) side of the battery activating, the music IC (U1).

## Project 107 Motor-controlled Lamp

Use the preceding circuit. Remove the phototransistor (Q4) and connect the motor (M1) across points A & B. The lamp (L1) lights for a few seconds and then turns off. Turn the slide switch (S1) on and turn the shaft of the motor and the lamp will light. As the motor turns, it produces a voltage. This is because there is a magnet and a coil inside the motor. When the axis turns the magnetic field will change and generate a small current in the coil and a voltage across its terminals. The voltage then activates the music IC (U1).

# Project 108

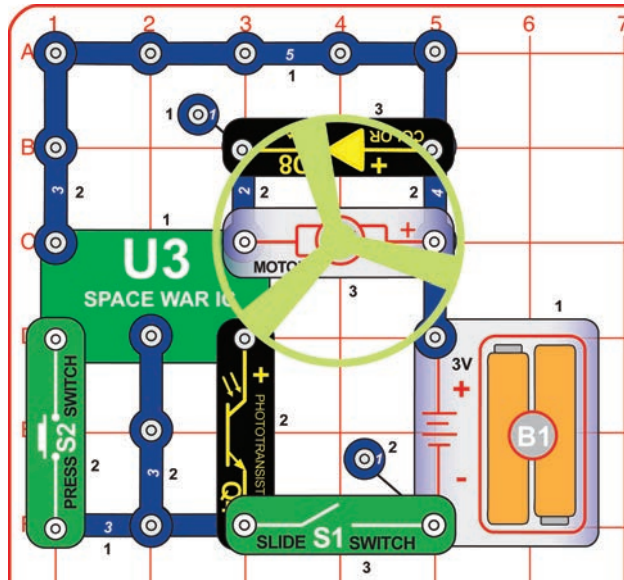

Turn on the slide switch (S1). Push the press switch and cover/uncover the phototransistor (Q4) to light the color LED (D8) and make the motor (M1) and fan spin at different speeds. The motor also produces sound.

**WARNING:** Moving parts. Do not touch the fan or motor during operation. Do not lean over the motor.

# Project 109

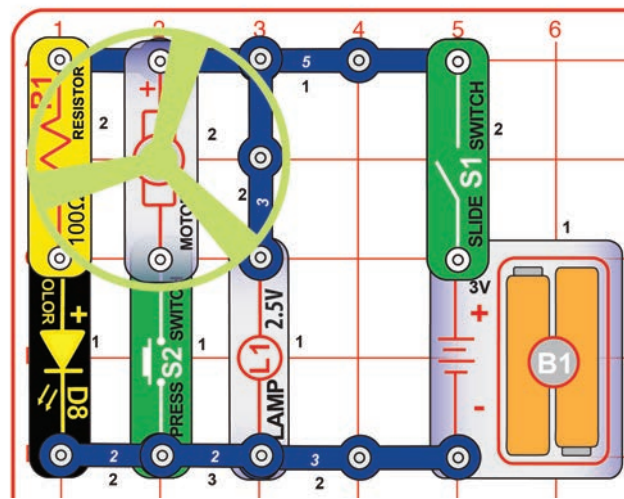

# Light Disrupter

Turn on the slide switch (S1); the lamp (L1) and color LED (D8) are on. Notice how the color LED is changing colors. Now push the press switch (S2) to spin the motor and glow fan. Notice how the color LED color pattern has changed. You can try this with or without the glow fan on the motor.

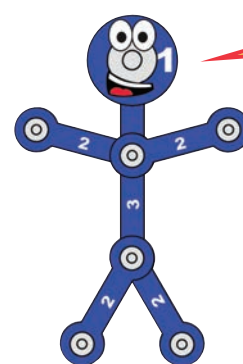

The motor produces electrical "noise" as it spins, which can confuse the color-changing circuit in the color LED. The lamp is just a simple light bulb, and is not affected by the

**WARNING:** Moving parts. Do not touch the fan or motor during operation. Do not lean over the motor.

# Project 110 Alarm Circuit

Build the circuit shown. When you turn on the slide switch (S1), the integrated circuit (U2) should start sounding a very loud alarm sound. This integrated circuit is designed to sweep through all the frequencies so even hard of hearing people can be warned by the alarm.

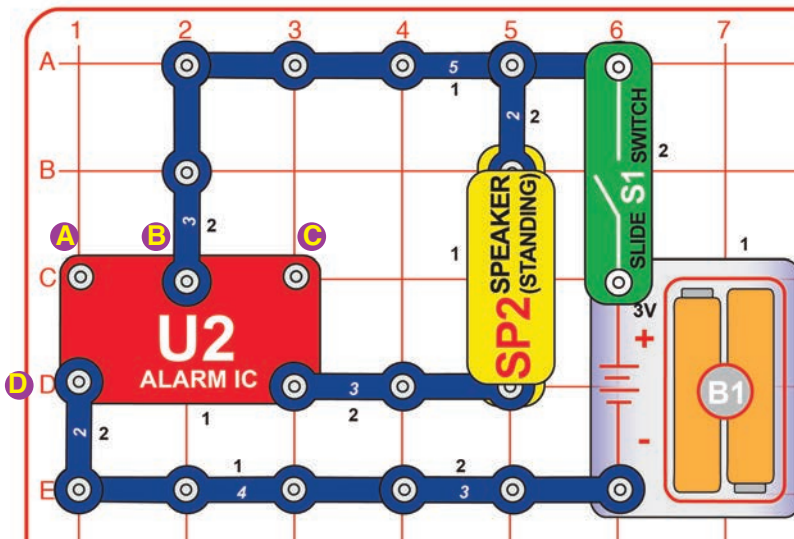

## Project 111 Machine Gun

Use the preceding circuit, but add a connection between the points marked B & C using a 1-snap and a 2-snap. Now it sounds like a machine gun.

## Project 112 Fire Engine

Use the preceding circuit, but remove the connection between B & C, and add a connection between A & B. Now it sounds like a fire engine.

## Project 113 European Siren

Use the preceding circuit, but remove the connection between B & C, and add a connection between A & D. Now it sounds like a European siren.

# Project 114 Quieter Alarm Circuits

Use the project 107 circuit, but add the 100Ω resistor (R1) in series with the speaker (SP2), as shown. Now the circuit is not as loud.

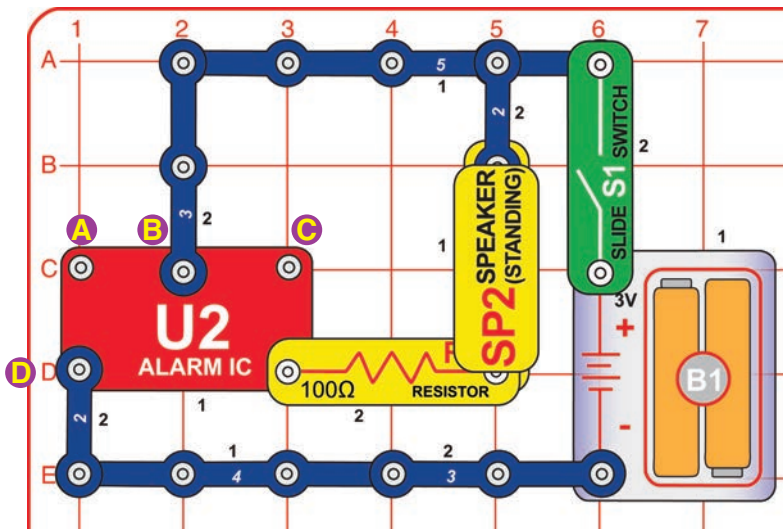

## Project 115 Quieter Machine Gun

Use the preceding circuit, but add a connection between the points marked B & C using a 1-snap and a 2-snap. Now it sounds like a machine gun.

## Project 116 Quieter Fire Engine

Use the preceding circuit, but remove the connection between B & C, and add a connection between A & B. Now it sounds like a fire engine.

## Project 117 Quieter European Siren

Use the preceding circuit, but remove the connection between B & C, and add a connection between A & D. Now it sounds like a European siren.



# Project 118

# Pencil Alarm

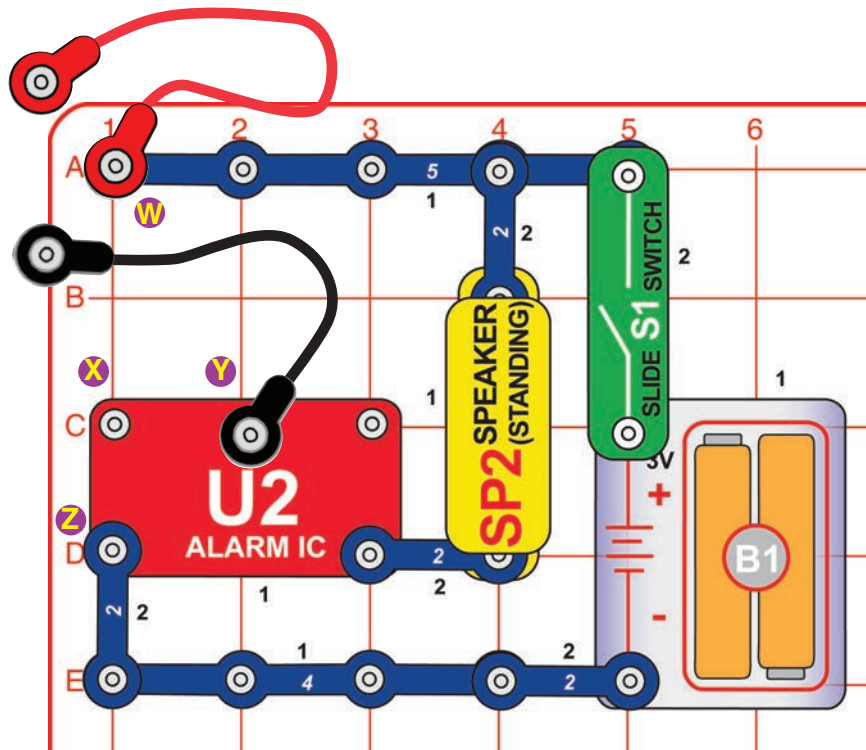

Build the circuit shown and connect the two jumpers to it, leave the loose ends of the jumpers unconnected for now. There is one more part you need and you are going to draw it. Take a pencil (No. 2 lead is best but other types will also work). **SHARPEN IT**, and fill in the shape below. You will get better results if you place a **hard**, flat surface directly beneath this page while you are drawing. Press **hard** (but don't rip the paper), and fill in the shape **several times** to be sure you have a **thick, even layer** of pencil lead.



Turn on the slide switch (S1) and take the loose ends of the jumpers, press them to the shape and move them around over the drawing. If you don't hear any sound then move the ends closer together and move over the drawing, add another layer of pencil lead, or put a drop of water on the jumper ends to get better contact.

Now you can draw your own shapes and see what kinds of sounds you can make.

The black core of pencils is graphite, the same material used in resistors.

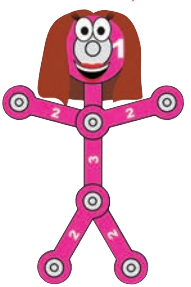

## Project 119 Pencil Sound

Remove the jumper connected to point Y (as shown in the drawing) and connect it to point X instead. Touch the loose ends to the pencil drawing again, the sound is different now.

## Project 120 Pencil Alarm Variant

Next connect a 2-snap wire between points X & Y and connect the jumper to either point. Touch the loose ends to the pencil drawing again, you hear a different sound.

## Project 121 Another Pencil Alarm Variant

Now remove the 2-snap wire between X & Y and connect it between X & Z, connect the jumpers to W & Y. Touch the loose ends to the pencil drawing again, you hear yet another sound. Now you can draw your own shapes and see what kinds of sounds you can make.



# Project 126 Symphony of Sounds

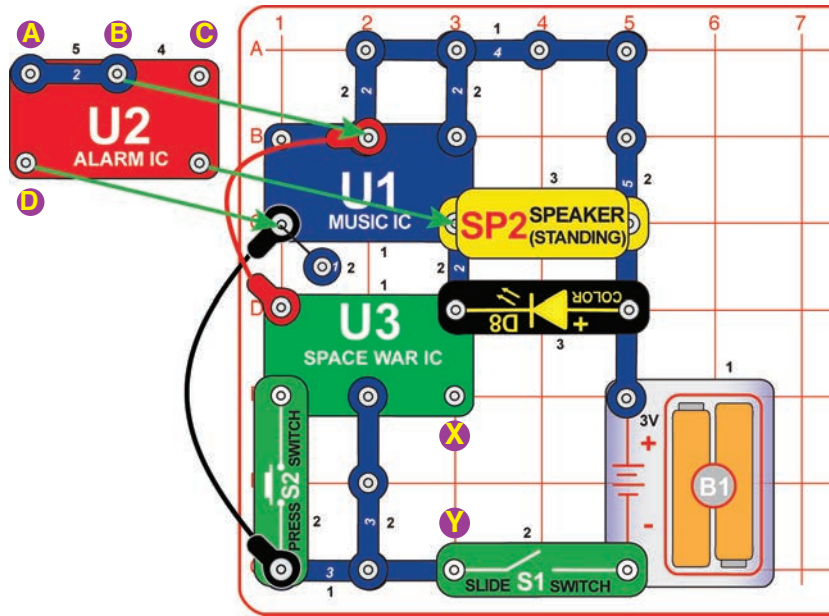

Turn on the slide switch (S1); you hear sounds from the music & alarm ICs (U1 & U2), and the color LED (D8) lights. Push the press switch (S2) several times to add sounds from the space war IC (U3).

This circuit has a lot happening at once.



# Project 127 Photo Symphony of Sounds

Use the preceding circuit, but add the phototransistor (Q4) across points X & Y using a 1-snap wire; the "+" side of Q4 should be towards U3.

# Project 128 Incandescent Symphony of Sounds

Use the preceding circuit, but replace the color LED (D8) with the lamp (L1).

# Project 129 Siren Symphony of Sounds

Use projects 126-128, but remove the 2-snap wire that is on top of U2.

# Project 130 Machine Gun Symphony of Sounds

Use projects 126-128, but move the 2-snap wire of top of U2 one space to the right (so it is across points B & C).

# Project 131 Euro Siren Symphony of Sounds

Use projects 126-128, but move the 2-snap wire of top of U2 to be across points A & D.

# Project 132 2-Light Symphony of Sounds

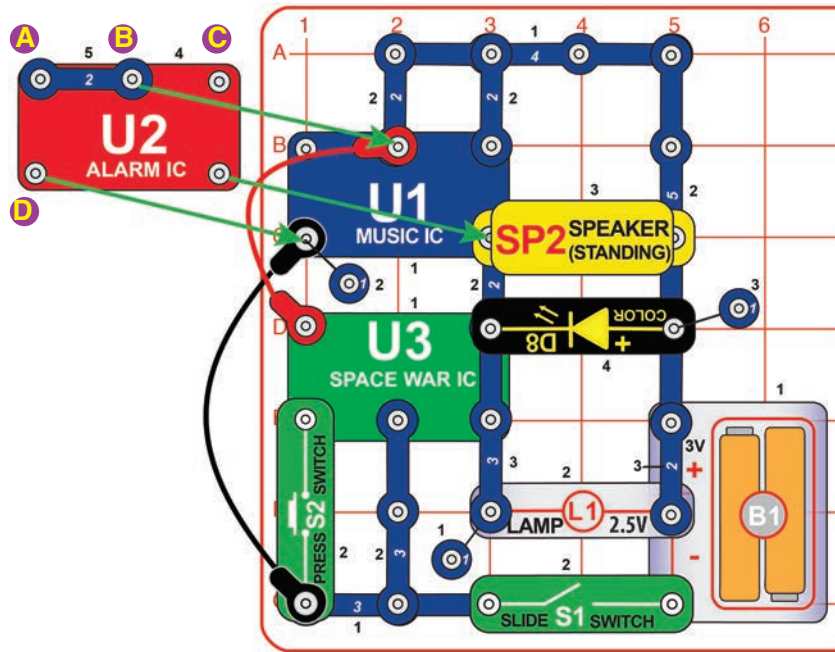

This circuit is similar to project 126 (Symphony of Sounds), but adds the lamp (L1). Note that the lamp does not snap on the battery holder (B1), but is secured by the 2-snap wire on level 3.

Turn on the slide switch (S1); you hear sounds from the music & alarm ICs (U1 & U2), and the color LED (D8) and lamp light. Push the press switch (S2) several times to add sounds from the space war IC (U3).

You can also use the variants in projects 127-131 here.

# Project 133 Super Symphony of Sounds

This circuit is similar to the preceding circuit, but also adds the motor (M1) and glow fan. Note that the speaker (SP2) does not snap on the battery holder (B1), but is secured by the 2-snap wire on level 3.

Turn on the slide switch (S1); you hear sounds from the music & alarm ICs (U1 & U2), the color LED (D8) & lamp (L1) light, and the motor spins the glow fan. Push the press switch (S2) several times to add sounds from the space war IC (U3).

You can also use the variants in projects 127-131 here.

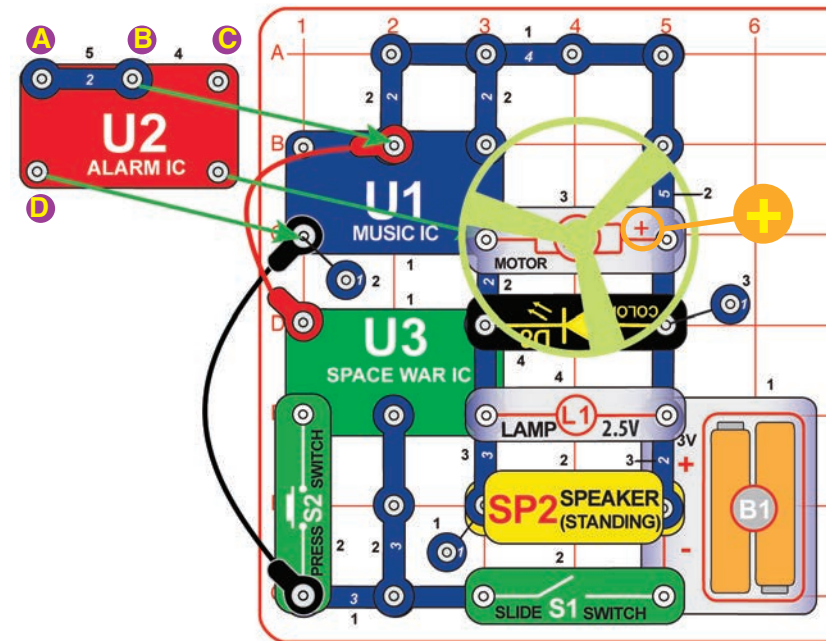

**WARNING:** Moving parts. Do not touch the fan or motor during operation. Do not lean over the motor. Fan may not rise until switch is released.

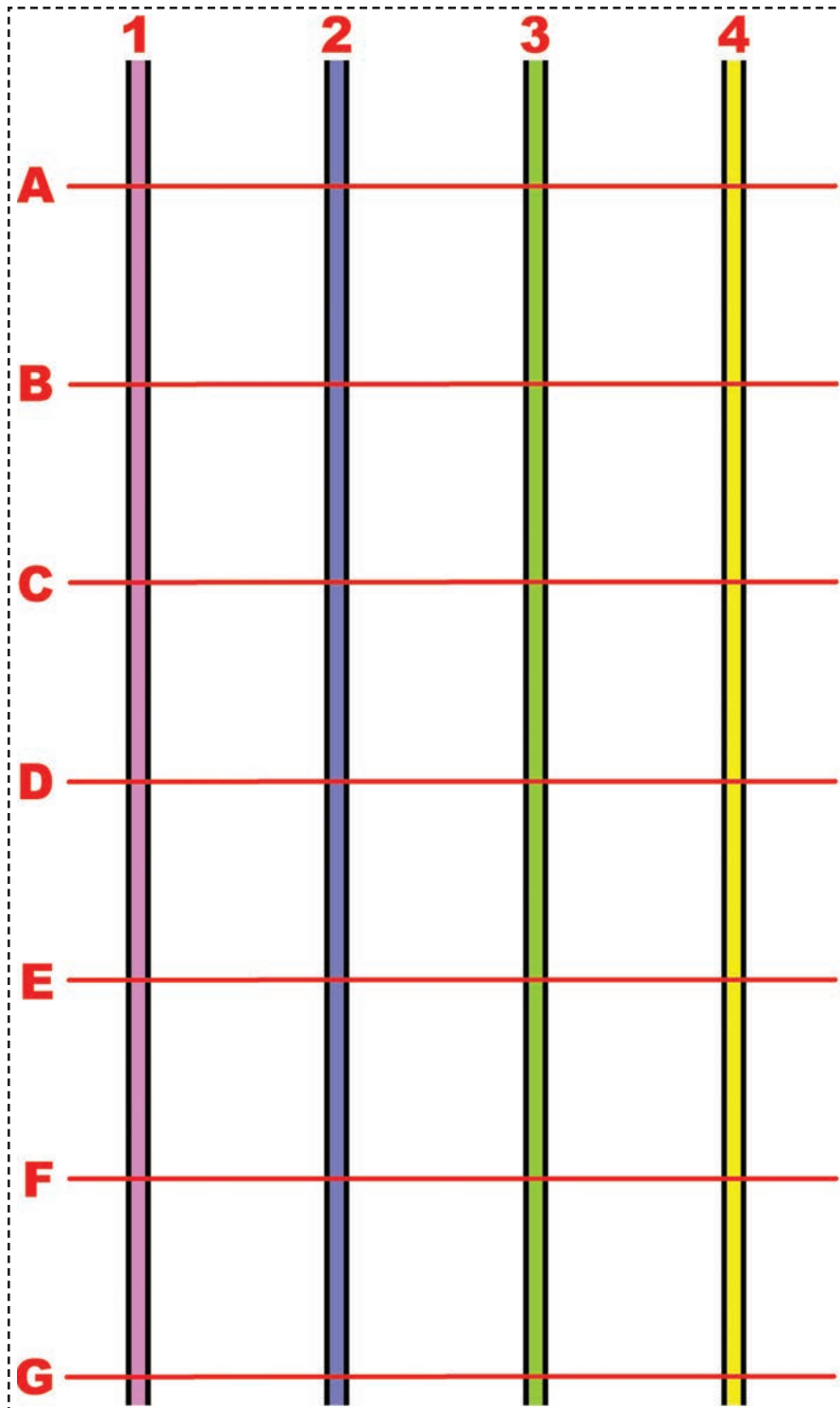

Page 31 for Project 66

← Page 32 for Project 68



# Notes

# OTHER SNAP CIRCUITS® PROJECTS!

For a listing of local toy retailers who carry Snap Circuits visit [www.elenco.com](http://www.elenco.com) or call us toll-free at 800-533-2441. For Snap Circuits accessories, additional parts, and more information about your parts visit [www.snapcircuits.net](http://www.snapcircuits.net).

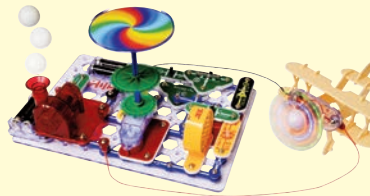

## Snap Circuits® Motion

**Model SCM-175**  
with over 165 projects

### FEATURES:

- Color changing lighted fan
- Air "fountain"
- Motion Detector
- Mini car
- Crawler
- Various gears and pulleys
- And so much MORE!!

## Snap Circuits®

**Model SC-300**  
with over 300 projects



With an easy-to-read color manual, students can jump right in and start building projects that teach about motors, batteries, lamps, speakers, resistors, capacitors and switches...just to name a few.

### Build over 300 projects

#### Including:

- AM Radio
- Water Detector
- Motion Detector
- Electronic Kazoo
- Burglar Alarm
- Lie Detector

### Contains Over 60 Parts

#### Including:

- Antenna Coil
- Microphone
- Variable Capacitor
- Five Fixed-value Capacitors
- High Frequency IC
- Two Transistors
- Adjustable Resistor
- Power Amplifier IC

## Snap Circuits® Pro

**Model SC-500**  
with over 500 projects



The full-color project book will make it a snap to construct projects related to transformers, relays, 7-segment LED displays, transistors and diodes. Also learn about series/parallel circuits, AM/FM radios, resistance and capacitance.

### Build over 500 projects

#### Including:

- Digitally Tuned FM Radio
- Adjustable Light Control
- Digital Voice Recorder
- Light Controlled Music
- AC Generator
- Flashing Numbers
- Music Meter
- Electronic Cat
- Plus all projects contained in the 300-in-1 (SC-300)!

### Contains Over 75 Parts

#### Including:

- FM Radio Module
- Analog Meter
- Recording IC Module
- 7-Segment LED Display
- Diode
- Relay
- SCR
- Transformer

## Snap Circuits® Extreme

**Model SC-750**  
with over 750 projects



Includes everything from SC-500 plus projects in solar, electromagnetism, vibration switches, and over 70 computer interfaced projects.

### Build over 750 projects

#### Including:

- Strobe Light
- Electromagnetism
- Transistor AM Radio
- Rechargeable Battery
- Mega Pulsar and Flasher
- Includes CI-73 Interface!
- Plus all projects contained in the 500-in-1 (SC-500)!

### Contains Over 80 Parts

#### Including:

- Solar Cell
- Electromagnet
- Vibration Switch
- Two-spring Socket
- CI-73 Downloadable Software

### FEATURES:

- Keyboard with optical theremin
- Echo effects
- Voice changer: record voice or music and play it back at different speeds
- Sound energy demonstration
- Connect to your smart phone and analyze sounds with apps

## Snap Circuits® Sound

**Model SCS-185**  
with over 185 projects

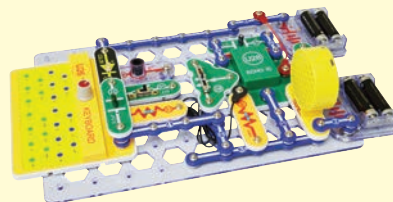

## Snap Circuits® Arcade

**Model SCA-200**  
with over 200 projects

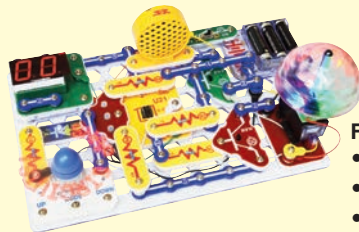

### FEATURES:

- Build over 200 projects
- Contains over 30 parts
- Tri-Color light orb
- Programmable word fan
- Dual LED display
- Internal microcontroller programmed for lots of games and other new modules

## Deluxe Snap Rover® Model SCROV-50

Introducing the next generation of the RC Snap Rover®! This version includes a disc launcher, digital voice recorder, and music sounds. Over 50 parts allow you to complete over 40 additional projects.



## Snap Circuits® Green

### Alternative Energy Kit Model SCG-125

Learn about energy sources and how to "think green". Build over 125 projects and have loads of fun learning about environmentally-friendly energy and how the electricity in your home works. Includes full-color manual with over 100 pages and separate educational manual. This educational manual will explain all the forms of environmentally-friendly energy including: geothermal, hydrogen fuel cells, wind, solar, tidal, hydro, and others. Contains over 40 parts.

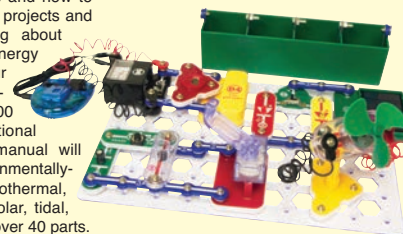

### Features:

- Contains over 55 parts
- Infrared detector
- Strobe light
- Color changing LED
- Glow-in-the-dark fan
- Strobe integrated circuit (IC)
- Fiber optic communication
- Color organ controlled by iPod® or other MP3 player, voice, and fingers.

## Snap Circuits® Light

**Model SCL-175**  
with over 175 projects

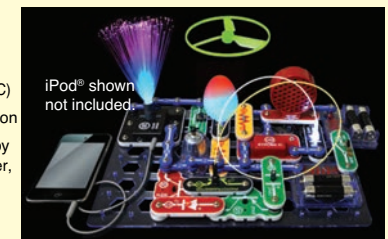

iPod® shown not included.

# SCB-20 Block Layout

**Important:** If any parts are missing or damaged, **DO NOT RETURN TO RETAILER.**  
Call Customer Service toll-free at (800) 533-2441 or e-mail us at: help@elenco.com.

**Note:** A complete parts list is on page 2 in this manual.

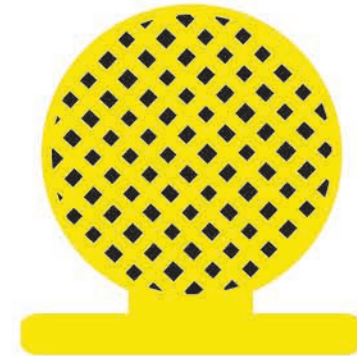
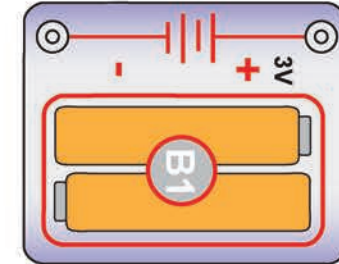
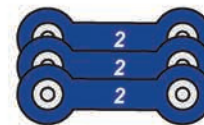
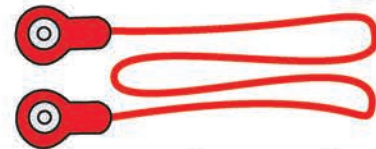
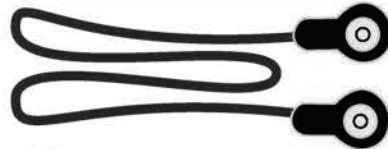

**ELENCO®**

150 Carpenter Ave. Wheeling, IL 60090 U.S.A.

Call us at: (847) 541-3800 • E-mail us at [elenco@elenco.com](mailto:elenco@elenco.com)

Visit us at: [www.elenco.com](http://www.elenco.com) / [www.snapcircuits.net](http://www.snapcircuits.net)

Copyright © 2015 All rights reserved. Colors and styles may vary.

Made in China