

BN 671 - DIN 125 A - ~ISO 7089

Flat washers
without chamfer

DIN 125 A
~ISO 7089
VSM 13904
~UNI 6592

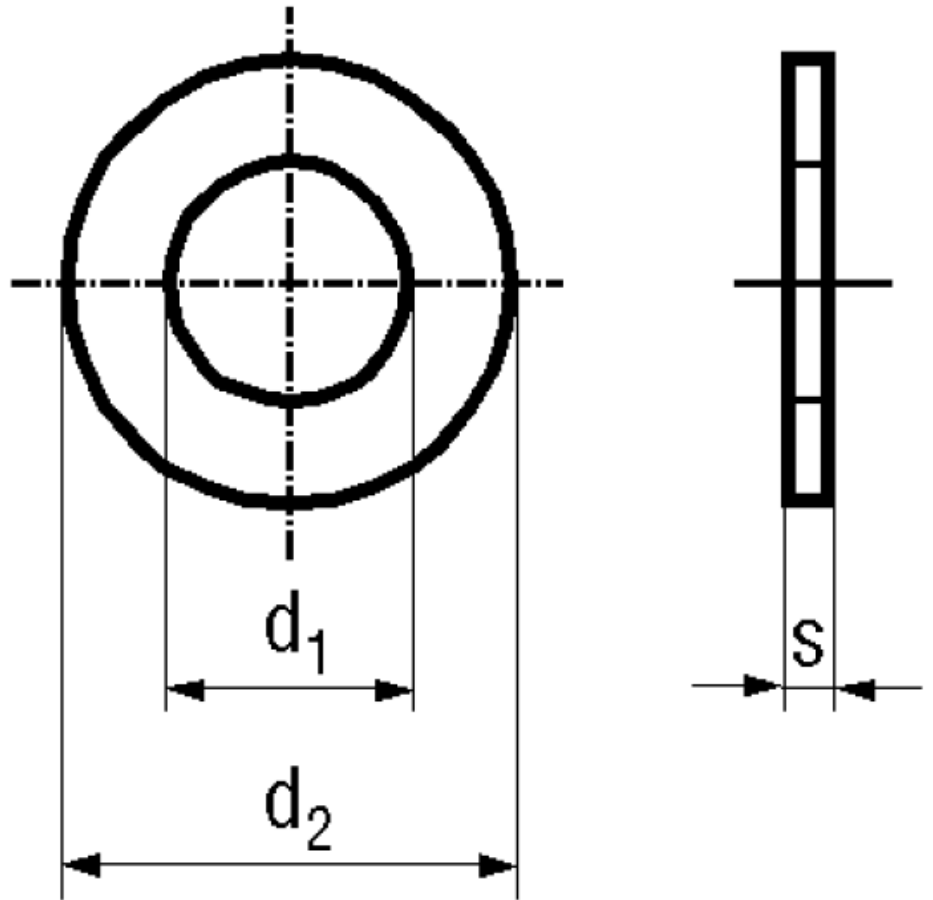

Material	Stainless steel	Hardness grade	140 HV
Quality	A4		

Article No. - 1253387

fit for	M5
d_1	5,3
d_2	10
s	1

DIN 125: Standard withdrawn