

PHOTOTRANSISTOR PRODUCTS SPECIFICATION

HPTB5-14D-B



Drawn by	Checked by	Approved by



DATE:2009/1/12

REV:F

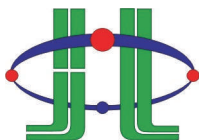

HUEY JANN ELECTRONICS INDUSTRY CO., LTD.

No.27 Line 466 Sec.2,Cannng-nan Rd. Wu-chi Town Taichung Shien, Taiwan, R.O.C.

TEL:+886-4-26393976 FAX:+886-4-26393125

DEVICES

Part Number	Lens		Source	
	Color	Diffusion	Dice Source	Color
HPTB5-14D-B	Black	Non-Diffused	---	Phototransistor

PACKAGE DIMENSIONS:

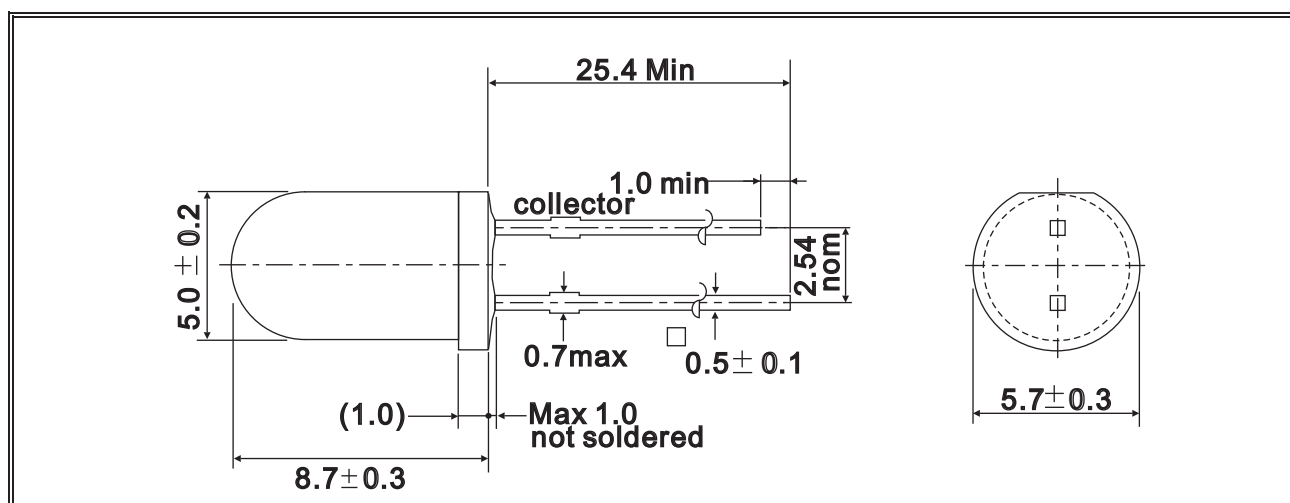

NOTE:

- 1.All dimensions are in millimeter.
- 2.Lead spacing is measured where the lead emerge from the package.
- 3.protruded resin under flange is 1.5mm max.
- 4.specifications are subject to change without notice.
- 5.Tolerance is ± 0.3 mm unless otherwise noted.

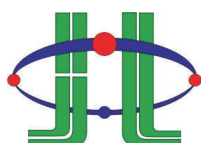

HUEY JANN ELECTRONICS INDUSTRY CO., LTD.

No.27 Line 466 Sec.2,Cannng-nan Rd. Wu-chi Town Taichung Shien, Taiwan, R.O.C.

TEL:+886-4-26393976 FAX:+886-4-26393125

ABSOLUTE MAXIMUM RATINGS

TA=25°C

PARAMETER	SYMBOL	MAX. RATING	UNIT
Power Dissipation	Pd	150	mW
Sensitive Area	AA	0.19	mm
Collector-Emitter Voltage	Vceo	30	V
Emitter-Collector Voltage	Veco	5	V
Operating Temperature	Topr	-40 ~ +85	°C
Storage Temperature	Tstg	-40 ~ +100	°C
Dip Soldering Temperature (3mm from case Bottom 260 °C for 5 seconds)			

*Iron soldering in 350°C within 5 seconds will not cause damage to the dice. But be aware of the high temperature will not only make the epoxy soften but also cause the lead moving and the gold wire broken and even open. So before returning to the normal temperature PLEASE AVOID any serious pressure on the top of epoxy and lead.

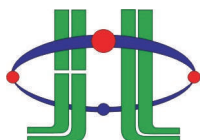

HUEY JANN ELECTRONICS INDUSTRY CO., LTD.

No.27 Line 466 Sec.2,Cannng-nan Rd. Wu-chi Town Taichung Shien, Taiwan, R.O.C.

TEL:+886-4-26393976 FAX:+886-4-26393125

ELECTRIC-OPTICAL CHARACTERISTICS

TA=25°C

PARAMETER	SYMBOL	TEST CONDITION	MIN	TYP	MAX	UNIT
Angle of Half Sensitive	$2\theta_{1/2}$			30		deg
Collector-Emitter Voltage	V_{ceo}	$I_c=1mA,$ $E_e=0mw/cm^2$	30			V
Emitter-Collector Voltage	V_{eco}	$I_c=100\mu A,$ $E_e=0mw/cm^2$		5		V
Collector-Emitter Saturation Voltage	V_{ces}	$I_c=0.5mA,$ $I_b=100\mu A$			0.4	V
Collector Current (Saturation)	I_c	$V_{ce}=5V,$ $E_e=0.5mw/cm^2$	0.8	3.0	12	mA
Collector Dark Current	I_{ceo}	$V_{ce}=20V,$ $E_e=0mw/cm^2$			100	nA
Ries Time	T_r	$V_{ce}=5V,$ $I_c=1mA,$		15		μS
Fall Time	T_f	$R_L=1000\Omega$		15		μS
Peak Wavelength	λ_p			940		nm
Sensitivity Wavelength	λ		760		1000	nm

*1.The dominate wavelength , λ_d , is derived from the CIE Chromaticity Diagram and represents the color of the device.

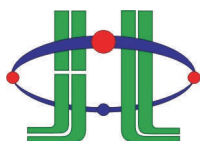

HUEY JANN ELECTRONICS INDUSTRY CO., LTD.

No.27 Line 466 Sec.2,Cannng-nan Rd. Wu-chi Town Taichung Shien, Taiwan, R.O.C.

TEL:+886-4-26393976 FAX:+886-4-26393125

TYPICAL ELECTRICAL OPTICAL CHARACTERISTICS CURVES

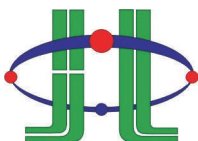
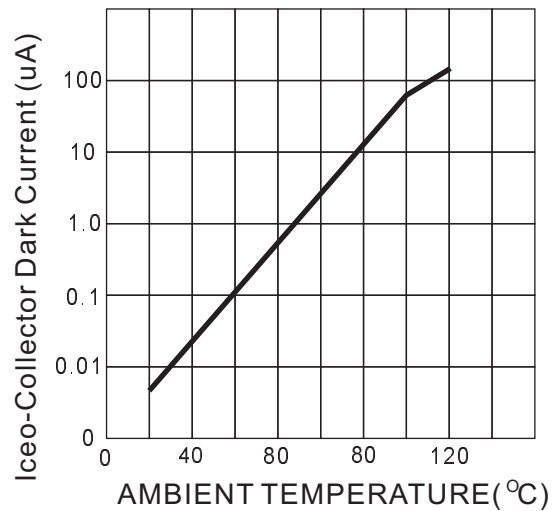
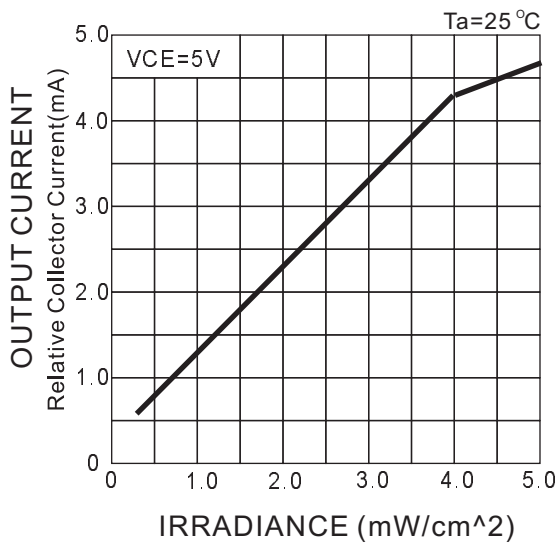
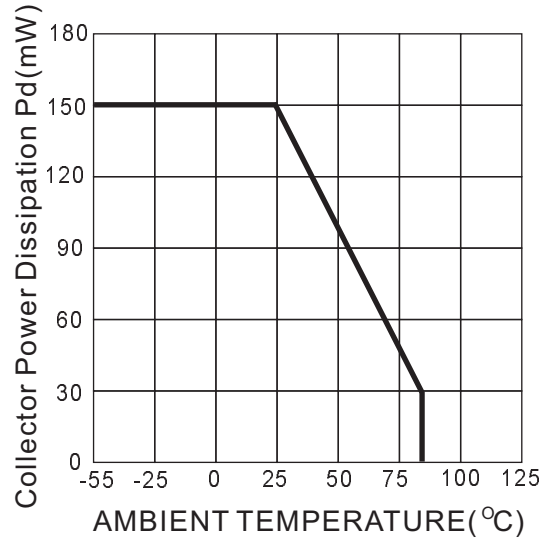
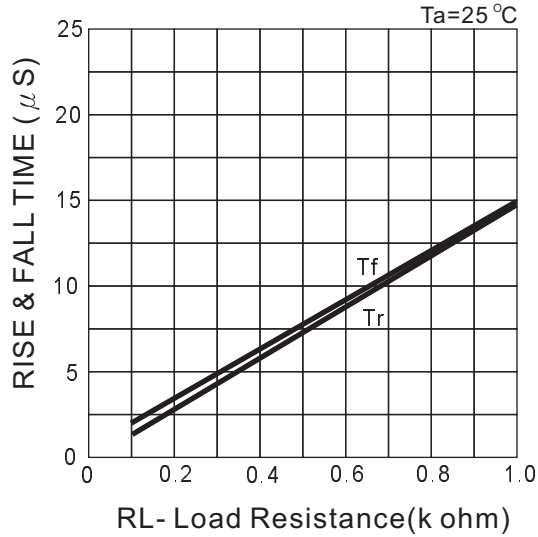

HUEY JANN ELECTRONICS INDUSTRY CO., LTD.

No.27 Line 466 Sec.2,Cannng-nan Rd. Wu-chi Town Taichung Shien, Taiwan, R.O.C.

TEL:+886-4-26393976 FAX:+886-4-26393125

TYPICAL ELECTRICAL OPTICAL CHARACTERISTICS CURVES

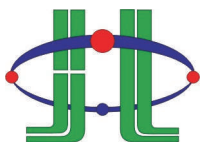
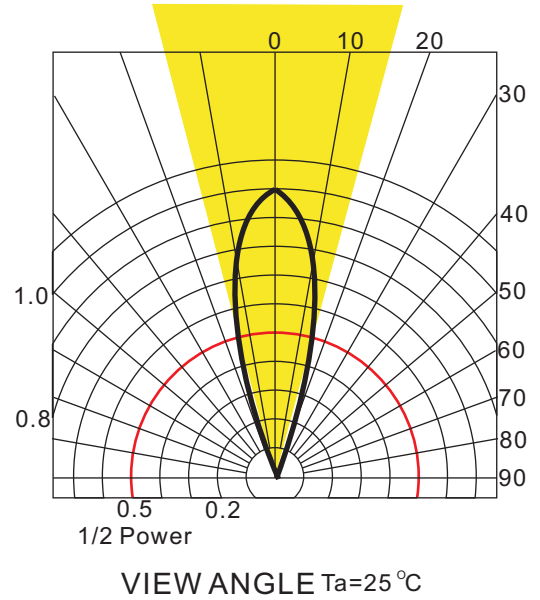
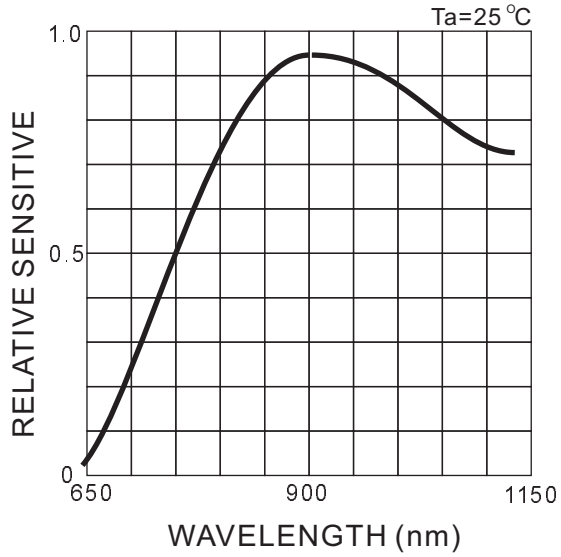

HUEY JANN ELECTRONICS INDUSTRY CO., LTD.

No.27 Line 466 Sec.2,Cannng-nan Rd. Wu-chi Town Taichung Shien, Taiwan, R.O.C.

TEL:+886-4-26393976 FAX:+886-4-26393125